

EN / DE / IT

coycama

BATHROOM FURNITURE

ÚNICO

What makes you **unique**?





Coycama stands out for its dedication to developing and producing products of the highest quality. Every aspect of the manufacturing process, from design to material selection and rigorous quality controls, is part of a complex system in continuous optimization. This commitment has been recognized with the ISO 9001 certification, the standard of excellence awarded by the International Organization for Standardization.

Coycama zeichnet sich durch sein Engagement aus, Produkte von höchster Qualität zu entwickeln und herzustellen. Jeder Aspekt des Fertigungsprozesses, von der Gestaltung über die Materialauswahl bis hin zu strengen Qualitätskontrollen, ist Teil eines komplexen Systems, das kontinuierlich optimiert wird. Dieses Engagement wurde mit der ISO 9001-Zertifizierung anerkannt, dem Exzellenzstandard, der von der Internationalen Organisation für Normung (ISO) verliehen wird.

Coycama si distingue per il suo impegno nello sviluppo e nella produzione di prodotti di altissima qualità. Ogni aspetto del processo di produzione, dalla progettazione alla selezione dei materiali e ai rigorosi controlli di qualità, fa parte di un sistema complesso in continua ottimizzazione. Questo impegno è stato riconosciuto con la certificazione ISO 9001, lo standard di eccellenza conferito dall'Organizzazione Internazionale per la Normazione (ISO).

Design, functionality, and quality are the fundamental pillars of our development at Coycama. Our philosophy is simple: to create products that are not only aesthetically appealing but also reflect a distinctive style and personality. Each of our products is designed with attention to detail, ensuring that they not only serve their purpose but also provide a meaningful experience for the user.

Design, Funktionalität und Qualität sind die grundlegenden Säulen unserer Entwicklung bei Coycama. Unsere Philosophie ist einfach: Produkte zu schaffen, die nicht nur ästhetisch ansprechend sind, sondern auch einen unverwechselbaren Stil und Persönlichkeit widerspiegeln. Jedes unserer Produkte wird mit Liebe zum Detail entworfen, um sicherzustellen, dass sie nicht nur ihren Zweck erfüllen, sondern auch eine bedeutungsvolle Erfahrung für den Benutzer bieten.

Design, funzionalità e qualità sono i pilastri fondamentali del nostro sviluppo in Coycama. La nostra filosofia è semplice: creare prodotti che non siano solo esteticamente attraenti, ma che riflettano anche uno stile e una personalità distintivi. Ogni nostro prodotto è progettato con attenzione ai dettagli, assicurando che non solo soddisfi la sua funzione, ma offra anche un'esperienza significativa per l'utente.



The Vinaròs facilities house a new production line that will provide increased manufacturing capacity, making us more competitive.

Die Vinaròs-Anlagen beherbergen eine neue Produktionslinie, die die Fertigungskapazität erhöht und uns wettbewerbsfähiger macht.

Gli impianti di Vinaròs ospitano una nuova linea di produzione che aumenterà la capacità produttiva, rendendoci più competitivi.



## INNOVATION

We continue investing in technology and development to achieve our goals, allowing us to be a flexible organization with high production capacity. Our vision for the future is to become an agile and competitive company that can easily adapt to the constant changes in today's society.

Wir investieren weiterhin in Technologie und Entwicklung, um unsere Ziele zu erreichen, was es uns ermöglicht, eine flexible Organisation mit hoher Produktionskapazität zu sein. Unsere Vision für die Zukunft ist es, ein agiles und wettbewerbsfähiges Unternehmen zu werden, das sich leicht an die ständigen Veränderungen der heutigen Gesellschaft anpasst.

Continuiamo a investire in tecnologia e sviluppo per raggiungere i nostri obiettivi, il che ci permette di essere un'organizzazione flessibile con un'elevata capacità produttiva. La nostra visione per il futuro è diventare un'azienda agile e competitiva, che si adatti facilmente ai cambiamenti costanti della società odierna.





## The future is ***green***, the future is Coycama.

At Coycama, we maintain our commitment to PEFC certification as an essential part of our sustainability strategy. This standard ensures that our products come from responsibly managed forests, caring for ecosystems and supporting local communities. At the same time, we continue to promote efficient management of forest resources, convinced that this approach is fundamental to balancing production and conservation. With PEFC certification, we reaffirm our responsibility in preserving forests and creating a sustainable future.

Bei Coycama setzen wir unser Engagement für die PEFC-Zertifizierung fort, die einen wesentlichen Bestandteil unserer Nachhaltigkeitsstrategie darstellt. Dieser Standard stellt sicher, dass unsere Produkte aus verantwortungsvoll bewirtschafteten Wäldern stammen, die Ökosysteme pflegen und lokale Gemeinschaften unterstützen. Gleichzeitig fördern wir weiterhin eine effiziente Bewirtschaftung der Waldressourcen, überzeugt davon, dass dieser Ansatz entscheidend ist, um Produktion und Naturschutz in Einklang zu bringen. Mit der PEFC-Zertifizierung bekräftigen wir unsere Verantwortung für die Bewahrung der Wälder und die Schaffung einer nachhaltigen Zukunft.

In Coycama, manteniamo il nostro impegno per la certificazione PEFC come parte essenziale della nostra strategia di sostenibilità. Questo standard garantisce che i nostri prodotti provengano da foreste gestite in modo responsabile, prendendosi cura degli ecosistemi e supportando le comunità locali. Allo stesso tempo, continuiamo a promuovere una gestione efficiente delle risorse forestali, convinti che questo approccio sia fondamentale per bilanciare la produzione e la conservazione. Con la certificazione PEFC, ribadiamo la nostra responsabilità nella conservazione delle foreste e nella creazione di un futuro sostenibile.



## ISO14001

Sustainability is a central part of our mission; therefore, we have adopted the ISO 14001 standard as a key step in our environmental commitment, managing our processes consciously and reducing impact at every stage of our activity. We are convinced that every small effort counts towards achieving a greener future. This is just the beginning of a continuous journey towards protecting the planet, always striving to improve and contribute to a more sustainable world for future generations.

Nachhaltigkeit ist ein zentraler Bestandteil unserer Mission. Daher haben wir die ISO 14001-Norm als wichtigen Schritt in unserem Umweltengagement übernommen, indem wir unsere Prozesse bewusst steuern und den Einfluss in jeder Phase unserer Tätigkeit reduzieren. Wir sind überzeugt, dass jeder kleine Beitrag dazu beiträgt, eine grünere Zukunft zu erreichen. Dies ist nur der Anfang einer kontinuierlichen Reise zum Schutz des Planeten, bei der wir stets bestrebt sind, uns zu verbessern und zu einer nachhaltigeren Welt für künftige Generationen beizutragen.

La sostenibilità è una parte centrale della nostra missione; per questo abbiamo adottato la norma ISO 14001 come un passo fondamentale nel nostro impegno ambientale, gestendo i nostri processi in modo consapevole e riducendo l'impatto in ogni fase della nostra attività. Siamo convinti che ogni piccolo sforzo contribuisca a raggiungere un futuro più verde. Questo è solo l'inizio di un viaggio continuo verso la protezione del pianeta, sempre cercando di migliorare e contribuire a un mondo più sostenibile per le generazioni future.



9 LANDES  
LANDES MOD.  
60 to 200

77 SAHARA  
60 - 80 - 100 - 120

15 colours / 15 farben / 15 colori

91 LAMBDA  
80 - 100 - 120

15 colours / 15 farben / 15 colori

103 CENIT  
80 - 100 - 120

113 BERLÍN  
60 - 70 - 80 - 100

121 TOSCANA  
60 - 80 - 100

131 DEPTH 46 | 40  
FLOW  
60 - 70 - 80 - 100 - 120 - 140

141 RUSTIK  
60 - 80 - 100 - 120

151 BAMBOO  
60 - 70 - 80 - 100

163 OSLO  
70 - 80 - 100 - 120

175 PRAGA  
60 - 70 - 80 - 100 - 120

187 HOLE  
80 - 90 - 100

195 GALSAKY  
GALSAKY MOD.  
60 to 200

225 GALSAKY IND.  
60 - 70 - 80 - 90 - 100

237 AVANT  
80 - 100

245 SPOK  
60 - 70 - 80 - 100

KIRK  
60 - 70 - 80 - 100

257 NUBIA  
60 - 80 - 100

15 colours / 15 farben / 15 colori

271 CERVINO  
70 - 80 - 90 - 100

281 ESCORPIO  
60 - 70 - 80 - 100

291 REDUCED DEPTH /  
REDUZIERTE TIEFE /  
PROFONDITÀ RIDOTTA  
COMET  
60 - 70 - 80

301 REDUCED DEPTH /  
REDUZIERTE TIEFE /  
PROFONDITÀ RIDOTTA  
BAMBI  
50 - 60

307 REDUCED DEPTH /  
REDUZIERTE TIEFE /  
PROFONDITÀ RIDOTTA  
VERSA  
45 - 55

317 REDUCED DEPTH /  
REDUZIERTE TIEFE /  
PROFONDITÀ RIDOTTA  
BERNA  
50 - 60

323 REDUCED DEPTH /  
REDUZIERTE TIEFE /  
PROFONDITÀ RIDOTTA  
SIENA  
70 - 80

327 SOLID SURFACE  
60 to 200

353 RESIN COLOUR  
60 to 200

15 colours / 15 farben / 15 colori

385 ÉPSILON  
60 - 80 - 100 - 120

15 colours / 15 farben / 15 colori

397 STONE.COMPACT  
STONEPLUS · ÁTIKA · PETRA · UMMA

407 TECHNICAL SPECIFICATIONS  
TECHNISCHE SPEZIFIKATIONEN  
SPECIFICHE TECNICHE

BASINS · MIRRORS · LIGHTING · ACCESSORIES  
WASCHBECKEN · SPIEGEL · BELEUCHTUNG · ERGÄNZUNGEN  
LAVABI · SPECCHI · ILLUMINAZIONE · COMPLEMENTI



# LANDES

COMPACT / MODULAR

60 to 200



EXAMPLE / BEISPIEL / ESEMPIO

## HOW TO ORDER?

WIE KANN ICH EINE BESTELLUNG AUFGEBEN?  
COME SI PREPARA UN ORDINE?

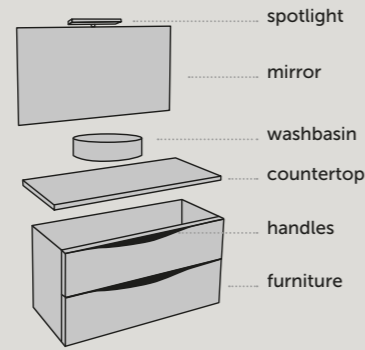

## THE REFERENCES DIE REFERENZEN LE REFERENZE

**112 35 080 (XX)**  
 modelo / modell / modelo    colour / farbe / colore    size / große / dimensione    handle / griff / maniglia

1

### CHOOSE THE FURNITURE

WÄHLE DEN WÄSCHTISCHSCHRANK  
SCEGLI IL MOBILE BAGNO

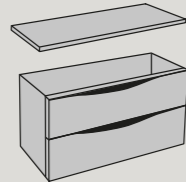

Matte White (35)	Walnut Vera (84)
Grey Pine (37)	Matte Anthracite (45)
Natural Oak (24)	

**112 35 080 (XX)**    **Module 2 Drawers**  
/ Modul 2 Schubladen / Modulo 2 Cassetti  
**112 35 208**    **Landes Countertop** / Abdeckung / Piano  
 507 01 004    Rotterdam

2

### CHOOSE THE HANDLE MODEL AND COLOUR

WÄHLE DAS MÖBELSTÜCK  
SCEGLI IL MOBILE

Replace XX with the model reference and handle finish:  
Ersetze XX durch die Modellreferenz und Griffausführung:  
Sostituisci XX con il riferimento del modello e la finitura della maniglia:

LINE	BEND
Matte Chrome (LC)	Matte Chrome (BC)
Matte Black (LN)	Matte Black (BN)
Matte White (LB)	
Matte Gold (LG)	

**DO NOT FORGET** / NICHT VERGESSEN / NON DIMENTICARE  
**112 35 080 (BC)**    **Module 2 Drawers**  
/ Modul 2 Schubladen / Modulo 2 Cassetti  
**112 35 208**    **Landes Countertop** / Abdeckung / Piano  
**425 14 080**    **Reinforcement Bar 80** / Waschtischplatten-  
Stabilisierung / Barra di rinforzo

To prevent deformations in the countertops, it is necessary to install the reinforcement bar in the modules where the washbasin will be placed.  
Um Verformungen der Arbeitsplatten zu vermeiden, muss die Verstärkungsstange in den Modulen installiert werden, auf denen das Waschbecken platziert wird.  
Per evitare deformazioni nei piani, è necessario installare la barra di rinforzo nei moduli su cui sarà posizionato il lavabo.

3

### CHOOSE WASHBASIN OR COUNTERTOP

WÄHLE WÄSCHBECKEN ODER AUFSATZ / SCEGLI LAVABO O DA APPOGGIO



425 14 080    Reinforcement Bar 80 / Waschtischplatten-  
Stabilisierung / Barra di rinforzo  
**507 01 004**    **Rotterdam**  
 204 00 080    Sun

4

### CHOOSE MIRROR

WÄHLEN SIE EINEN SPIEGEL AUS / SCEGLIERE LO SPECCHIO



507 01 004    Rotterdam  
 204 00 080    Sun  
 400 14 161    Nerea

5

### CHOOSE SPOTLIGHT

WÄHLEN SIE DAS LED BELEUCHTUNG / SCEGLIERE LE LAMPADIE DA PARETE



204 00 080    Sun  
**400 14 141**    **Nerea**  
 112 24 435    Landes Medium / Mittel / Medio

6

### CHOOSE AUXILIARY UNITS AND ACCESSORIES

ZUSÄTZLICHE ELEMENTE UND ZUBEHÖR AUSWÄHLEN / SCEGLIERE UNITÀ E SCAFFALIE O COMPLEMENTI

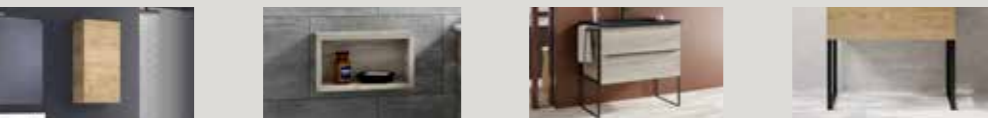

**112 24 435**    **Landes Medium** / Mittel / Medio  
**412 02 725**    **Kuadro Legs** / Beine / Gambe  
 total



## LANDES

The Landes model is designed and perfected for the most demanding users. Its advanced manufacturing system and the highest quality components result in a premium product that stands out for its resistance, durability, and practicality. Additionally, its customization options allow you to create a unique space.

Das Modell Landes ist für die anspruchsvollsten Nutzer konzipiert und perfektioniert. Sein fortschrittliches Fertigungssystem und die höchste Qualität der Komponenten ergeben ein Premium-Produkt, das sich durch Widerstandsfähigkeit, Langlebigkeit und Praktikabilität auszeichnet. Darüber hinaus ermöglichen seine Anpassungsoptionen die Gestaltung eines einzigartigen Raums.

Il modello Landes è progettato e perfezionato per gli utenti più esigenti. Il suo avanzato sistema di produzione e la massima qualità dei componenti danno vita a un prodotto premium che si distingue per resistenza, durata e praticità. Inoltre, le sue opzioni di personalizzazione permettono di creare uno spazio unico.



**MAXIMUM QUALITY**  
HÖCHSTE QUALITÄT  
MASSIMA QUALITÀ

Manufactured with the most advanced systems.  
Hergestellt mit den modernsten Systemen.  
Prodotto con i sistemi più avanzati.



**PEFC CERTIFICATE**  
PEFC-ZERTIFIKAT  
CERTIFICATO PEFC

Promoting sustainable forest management.  
Förderung der nachhaltigen Forstwirtschaft.  
Promuovendo la gestione forestale sostenibile.



**WATER-REPELLENT PANEL**  
WASSERABWEISENDES PANEL  
PANNELLO IDROFUGO

New generation of more water-resistant board.  
Neue Generation einer wasserbeständigeren Platte.  
Nuova generazione di pannelli più resistenti all'acqua.



**FULL EXTENSION**  
VOLLAUSZUG  
ESTRAZIONE TOTALE

Drawer with full extension system.  
Schublade mit Vol্লাuszugssystem.  
Cassetto con sistema di estrazione totale.



**GRASS RUNNERS**  
GRASS-SCHIENEN  
GUIDE GRASS

High-strength and high-quality metal rail. Adjustable front.  
Hochfeste und hochwertige Metallreling. Verstellbare Front.  
Guida metallica ad alta resistenza e qualità. Frontale regolabile.



**CUSTOMIZABLE**  
PERSONALISIERBAR / PERSONALIZZABILE

Multiple customization options in finishes, sizes, handles, and accessories.  
Mehrere Personalisierungsoptionen in Oberflächen, Maßen, Griffen und Zubehör.  
Molteplici opzioni di personalizzazione in finiture, misure, maniglie e accessori.

### LINE HANDLE









### BEND HANDLE



“**Design** is the art of balancing form and function.”





-  Metal interior drawers. Metallzierleiste. Sistema di estrazione metallico.
-  Total extraction. Vollauszug. Estrazione totale.
-  Organizer unit. Utensilien Behälter. Organizzatore.
-  Soft close. Soft-close-System. Chiusura ammortizzata.
-  GRASS Grass sliding system. Korpussschiene Grass. Guide Grass.
-  Water resistant. Wasserabweisend. Indrorepellente.



## LANDES 60

- 112 35 060 LG Landes 60
- 522 01 080 Quattro
- 405 03 000 Overflow Cover Matte Gold / Überlauf / Troppo Pieno
- 239 72 080 Soul Gold
- 112 74 505 Shelf Horizontal Mink / Regal Horizontal / Scaffale Orizzontale
- 112 48 520 Shelf L Sunset / Regal L / Scaffale L
- 412 00 802 Combi Gold

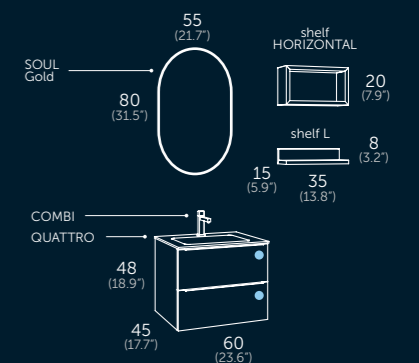

### LINE HANDLE

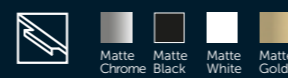





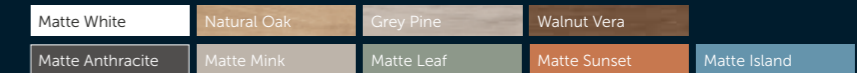

### BEND HANDLE



### FURNITURE





-  Metal interior drawers.  
Metallzierleiste.  
Sistema di estrazione metallico.
-  Total extraction.  
Vollauszug.  
Estrazione totale.
-  Organizer unit.  
Utensilien Behälter.  
Organizatore.
-  Soft close.  
Soft-close-System.  
Chiusura ammortizzata.
-  GRASS  
Grass sliding system.  
Körpuschiene Grass.  
Guide Grass.
-  Push to open.  
Push-to-open-System.  
Sistema Push.
-  Resistant to water.  
Wasserabweisend.  
Indrorepellente.

LINE HANDLE

-   Matte Chrome
- Matte Black
- Matte White
- Matte Gold

BEND HANDLE

-   Matte Chrome
- Matte Black

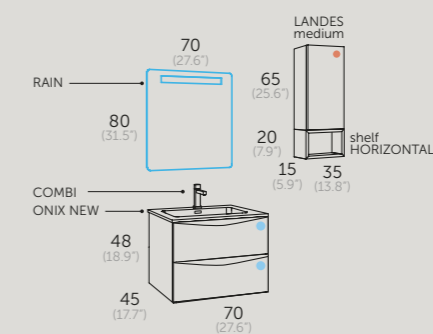

**LANDES 70**

- 112 45 070 BN Landes 70
- 550 01 070 Onix New
- 269 00 070 Rain
- 112 45 435 Landes Medium Anthracite / Mittel / Medio
- 112 47 505 Shelf Horizontal Leaf / Regal Horizontal / Scaffale Orizzontale
- 412 00 801 Combi Black



FURNITURE

- |                  |             |            |              |
|------------------|-------------|------------|--------------|
| Matte White      | Natural Oak | Grey Pine  | Walnut Vera  |
| Matte Anthracite | Matte Mink  | Matte Leaf | Matte Sunset |
|                  |             |            | Matte Island |



-  Metal interior drawers.  
Metallzierleiste.  
Sistema di estrazione metallico.
-  Total extraction.  
Vollauszug.  
Estrazione totale.
-  Organizer unit.  
Utensilien Behälter.  
Organizatore.
-  Soft close.  
Soft-close-System.  
Chiusura ammortizzata.
-  GRASS  
Grass sliding system.  
Korpusschiene Grass.  
Guide Grass.
-  Soft close.  
Soft-close-System.  
Chiusura ammortizzata.
-  Push to open.  
Push-to-open-System.  
Sistema Push.
-  Water resistant.  
Wasserabweisend.  
Indrorepellente.
-  Anti fog system.  
Anti-Beschlag-System.  
Sistema antiappannamento.
-  Ambient light.  
Umgebungslicht.  
Luce ambiente.
-  Intensity control.  
Intensitätsregler.  
Regolatore di intensità.
-  Dual sensor On/Off-anti fog.  
Doppelter Sensorschalter, On/Off.  
Doppio sensore touch, On/Off.  
Antiappannante.



## LANDES MODULAR 80

112 24 060 LC Landes Module 2 Drawers 60 / Modul 2 Schubladen / Modulo 2 Cassetti  
 112 24 020 LC Landes Module Door 20 / Modul Tür / Modulo Porta  
 506 01 081 G Ambar (60+20) Left / Links / Sinistra  
 without tap hole / Ohne Hahnloch / Senza foro per rubinetto  
 246 00 080 Verona  
 112 24 336 LC Landes Tall Right Natural Oak / Hoch / Alto  
 412 00 808 Combi Wall-Mounted Chrome

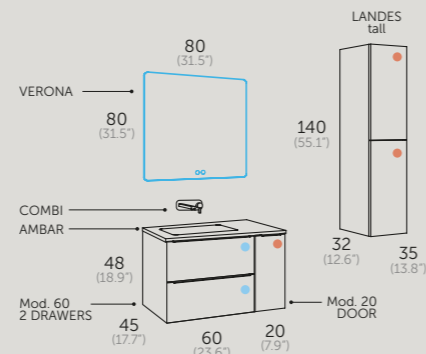

### LINE HANDLE

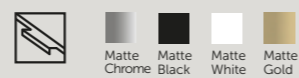

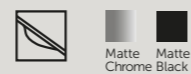

### BEND HANDLE

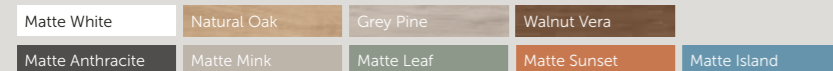

### FURNITURE





-  Metal interior drawers. Metallzierleiste. Sistema di estrazione metallico.
-  Total extraction. Vollauszug. Estrazione totale.
-  Organizer unit. Utensilien Behälter. Organizzatore.
-  Soft close. Soft-close-System. Chiusura ammortizzata.
-  GRASS Grass sliding system. Körperschiene Grass. Guide Grass.
-  Soft close. Soft-close-System. Chiusura ammortizzata.
-  Push to open. Push-to-open-System. Sistema Push.
-  Water resistant. Wasserabweisend. Indrorepellente.
-  Anti fog system. Anti-Beschlag-System. Sistema antiappannamento.
-  Dual sensor On/Off-anti fog. Doppelter Sensorschalter. On/Off. Doppio sensore di con tatto. On/Off. Antiappannante.



## LANDES 80

- 112 37 080 LN Landes 80
- 412 02 756 Leg Industrial with towel rail / Mit Handtuchhalter / Con Porta Asciugamani
- 412 02 754 Leg Industrial without towel rail / Ohne Handtuchhalter / Senza Porta Asciugamani
- 540 02 080 Mara Black
- 250 02 080 Aura
- 112 37 435 Landes Medium Grey Pine / Mittel / Medio
- 112 37 500 Shelf X3 Vertical Grey Pine / Regal X3 Vertikal / Scaffale X3 Verticale
- 412 02 810 Kudo Black

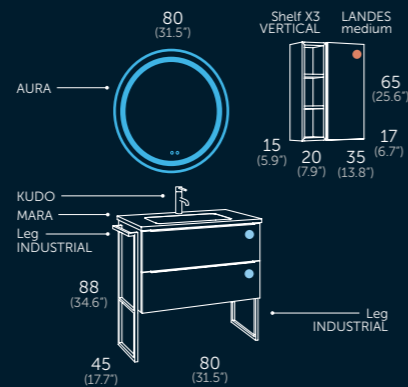
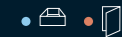

### FURNITURE

Matte White	Natural Oak	Grey Pine	Walnut Vera
Matte Anthracite	Matte Mink	Matte Leaf	Matte Sunset
			Matte Island

### LINE HANDLE

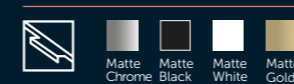

### BEND HANDLE

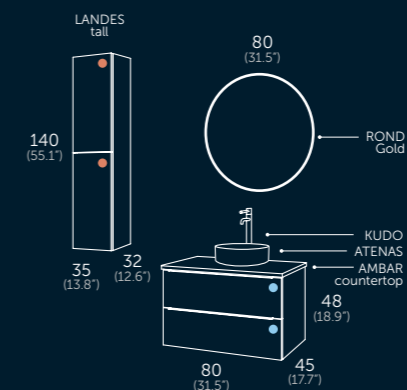

## LANDES 80

- 112 84 080 LG Landes 80
- 580 01 037 Atenas
- 508 01 080 Ambar Countertop / Abdeckung / Piano
- 425 14 080 Reinforcement Bar / Waschtischplatten-Stabilisierung / Barra di rinforzo
- 244 72 080 Rond Gold
- 112 84 337 LG Landes Tall Left Walnut Vera / Hoch Links / Alto Sinistra
- 412 03 815 Kudo Tall Brushed Gold / Hoch Gebürstet / Alto Spazzolato





-  Metal interior drawers.  
Metallzierleiste.  
Sistema di estrazione metallico.
-  Total extraction.  
Vollauszug.  
Estrazione totale.
-  Organizer unit.  
Utensilien Behälter.  
Organizzatore.
-  Soft close.  
Soft-close-System.  
Chiusura ammortizzata.
-  GRASS  
Grass sliding system.  
Körpuschiene Grass.  
Guide Grass.
-  Soft close.  
Soft-close-System.  
Chiusura ammortizzata.
-  Push to open.  
Push-to-open-System.  
Sistema Push.
-  Water resistant.  
Wasserabweisend.  
Indrorepellente.
-  Anti fog system.  
Anti-Beschlag-System.  
Sistema antiappannamento.
-  Ambient light.  
Umgebungslicht.  
Luce ambiente.
-  Intensity control.  
Intensitätsregler.  
Regolatore di intensità.
-  Dual sensor On/Off-anti fog.  
Doppelter Sensorschalter, On/Off.  
Doppio sensore touch, On/Off.  
Antiappannante.

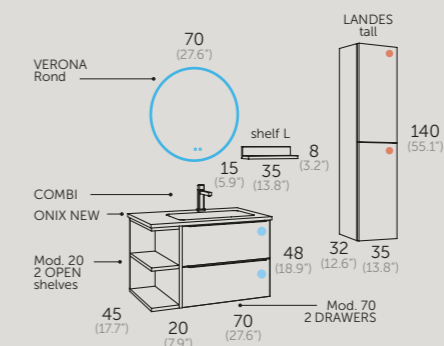





**LANDES MODULAR 90**



112 35 070 LN	Landes Module 2 Drawers 70 / Modul 2 Schubladen / Modulo 2 Cassetti
112 49 025	Landes Module 2 Open Shelves 20 / Modul 2 Offene Regale / Modulo 2 Scaffali Aperti
550 01 093	Onix New (20+70) Right / Rechts / Destra
405 02 000	Overflow Cover Black Matte / Überlauf / Troppo pieno
247 00 070	Verona Rond
112 35 336 LN	Landes Tall Right White / Hoch Rechts / Alto Destra
112 49 520	Shelf L Island / Regal L / Scaffale L
412 00 801	Combi Black

**LINE HANDLE**

 Matte Chrome  
 Matte Black  
 Matte White  
 Matte Gold









**BEND HANDLE**

 Matte Chrome  
 Matte Black

**FURNITURE**

 Matte White  
 Natural Oak  
 Grey Pine  
 Walnut Vera  
 Matte Anthracite  
 Matte Mink  
 Matte Leaf  
 Matte Sunset  
 Matte Island



-  Metal interior drawers. Metallzierleiste. Sistema di estrazione metallico.
-  Total extraction. Vollauszug. Estrazione totale.
-  Organizer unit. Utensilien Behälter. Organizzatore.
-  Soft close. Soft-close-System. Chiusura ammortizzata.
-  GRASS Grass sliding system. Körperschiene. Grass. Guide Grass.
-  Push to open. Push-to-open-System. Sistema Push.
-  Water resistant. Wasserabweisend. Indrorepellente.
-  Magnifying zoom in Mirror. Lupe 3x. Vergrößerung. Lente d'ingrandimento 3x.
-  Anti fog system. Anti-Beschlag-System. Sistema antiappannamento.
-  Dual sensor On/Off-anti fog. Doppelter Sensorschalter. On/Off. Doppio sensore di con tatto. On/Off. Antiappannante.

LINE HANDLE



BEND HANDLE



LANDES 100

- 112 24 100 LB Landes 100
- 522 01 100 Quattro
- 270 00 100 Cosmos
- 112 24 435 Landes Medium Natural Oak / Mittel / Medio
- 112 35 505 Shelf Horizontal White / Regal Horizontal / Scaffale Orizzontale
- 412 24 800 Combi Chrome - Natural Oak

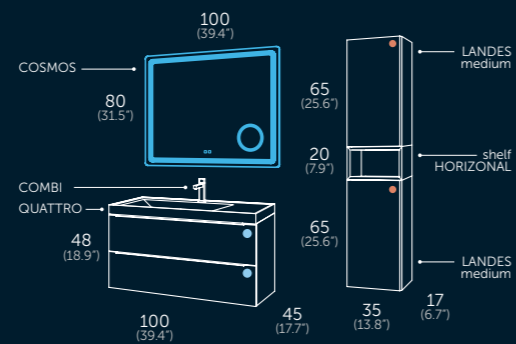

FURNITURE

Matte White	Natural Oak	Grey Pine	Walnut Vera
Matte Anthracite	Matte Mink	Matte Leaf	Matte Sunset
			Matte Island





LINE HANDLE



BEND HANDLE

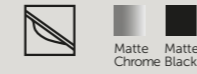

-  Metal interior drawers.  
Metallzierleiste.  
Sistema di estrazione metallico.
-  Total extraction.  
Vollauszug.  
Estrazione totale.
-  Organizer unit.  
Utensilien Behälter.  
Organizzatore.
-  Soft close.  
Soft-close-System.  
Chiusura ammortizzata.
-  GRASS  
Grass sliding system.  
Korpusschiene Grass.  
Guide Grass.
-  Push to open.  
Push-to-open-System.  
Sistema Push.
-  Water resistant.  
Wasserabweisend.  
Indrorepellente.
-  Anti fog system.  
Anti-Beschlag-System.  
Sistema antiappannamento.
-  Ambient light.  
Umgebungslicht.  
Luce ambiente.
-  Intensity control.  
Intensitätsregler.  
Regolatore di intensità.
-  Dual sensor On/Off-anti fog.  
Doppelter Sensorschalter, On/Off.  
Doppio sensore touch, On/Off.  
Antiappannante.

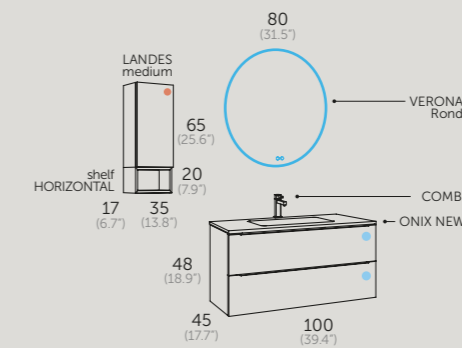

LANDES 100

- 112 45 100 LG Landes 100
- 550 01 100 Onix New
- 247 00 080 Verona Rond
- 112 45 435 Landes Medium Anthracite / Mittel / Medio
- 112 48 505 Shelf Horizontal Sunset / Horizontales Regal / Scaffale Orizzontale
- 412 00 802 Combi Gold



FURNITURE

Matte White	Natural Oak	Grey Pine	Walnut Vera
Matte Anthracite	Matte Mink	Matte Leaf	Matte Sunset
			Matte Island

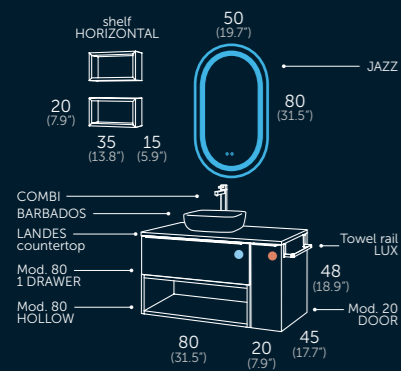

## LANDES MODULAR 100

- 112 37 083 LN Landes Module 1 Drawer 80 / Hohlmodul 1 Schublade / Modulo 1 Cassetto
- 112 47 085 Landes Module Hollow 80 / Hohlmodul / Modulo Cavo
- 112 37 020 LN Landes Module Door 20 / Türmodul / Modulo Porta
- 112 37 210 Landes Countertop / Abdeckung / Piano
- 425 14 080 Reinforcement Bar 80 / Waschtischplatten-Stabilisierung / Barra di rinforzo
- 583 25 037 Barbados Leaf
- 271 02 050 Jazz
- 112 47 505 Shelf Horizontal Leaf / Regal Horizontal / Scaffale Orizzontale
- 112 37 505 Shelf Horizontal Grey Pine / Regal Horizontal / Scaffale Orizzontale
- 417 02 038 Towel rail Lux 38 Black / Handtuchhalter / Porta Asciugamani
- 412 00 806 Combi Tall Black / Hoch / Alto

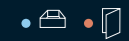

Metal interior drawers. Metallzierleiste. Sistema di estrazione metallico.

Total extraction. Vollauszug. Estrazione totale.

Organizer unit. Utensilien Behälter. Organizzatore.

Soft close. Soft-close-System. Chiusura ammortizzata.

GRASS Grass sliding system. Korpussschiene. Grass. Guide Grass.

Soft close. Soft-close-System. Chiusura ammortizzata.

Water resistant. Wasserabweisend. Indrorepellente.

Anti fog system. Anti-Beschlag-System. Sistema antiappannamento.

Dual sensor On/Off-anti fog. Doppelter Sensorschalter. On/Off. Doppio sensore di con tatto. On/Off. Antiappannante.

### LINE HANDLE

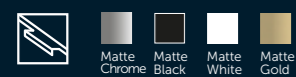

### BEND HANDLE



### FURNITURE

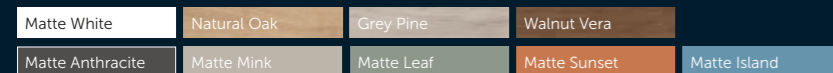

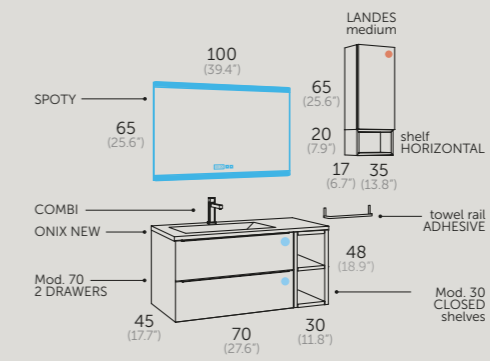

## LANDES MODULAR 100

- 112 84 070 LC Landes Module 2 Cajones 70 / Hohlmodul 2 Schubladen / Modulo 2 Cassetti
- 112 84 032 Landes Module Closed Shelves 30 / Modul für Geschlossene Regale / Modulo Scaffali Chiusi
- 550 01 101 Onix New (70+30) Left / Links / Sinistra
- 267 00 100 Spoty
- 112 84 435 Landes Medium Walnut Vera / Mittel / Medio
- 112 35 505 Shelf Horizontal White / Horizontales Regal / Scaffale Orizzontale
- 416 00 037 Towel rail Adhesive 3M Chrome / Selbstklebender Handtuchhalter 3M / Porta Asciugamani Adesivo 3M
- 412 00 800 Combi Chrome

- Metal interior drawers. Metallzierleiste. Sistema di estrazione metallico.
- Total extraction. Völlauszug. Estrazione totale.
- Organizer unit. Utensilien Behälter. Organizzatore.
- Soft close. Soft-close-System. Chiusura ammortizzata.
- GRASS Grass sliding system. Körperschiene Grass. Guide Grass.
- Push to open. Push-to-open-System. Sistema Push.
- Water resistant. Wasserabweisend. Indirorepellente.
- Anti fog system. Anti-Beschlag-System. Sistema antiappannamento.
- Ambient light. Umgebungslicht. Luce ambiente.
- Digital clock. Digitaluhr. Orologio digitale.
- Dual sensor On/Off-anti fog. Doppelter Sensorschalter. On/Off. Doppio sensore touch. On/Off. Antihappannante.
- Bluetooth music player. 2 speakers of 3W each. Musik Player integriert, Bluetooth Anschluss. 2 Lautsprecher je mit 3W. Lettore musicale integrato, connessione a Bluetooth. 2 altoparlanti 3W ciascuno.

### LINE HANDLE

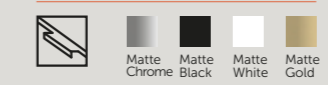



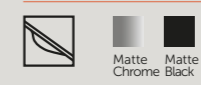



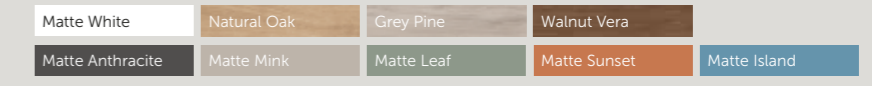

### BEND HANDLE



### FURNITURE





-  Metal interior drawers. Metallzierleiste. Sistema di estrazione metallico.
-  Total extraction. Vollauszug. Estrazione totale.
-  Organizer unit. Utensilien Behälter. Organizzatore.
-  Soft close. Soft-close-System. Chiusura ammortizzata.
-  GRASS Grass sliding system. Körperschiene Grass. Guide Grass.
-  Soft close. Soft-close-System. Chiusura ammortizzata.
-  Push to open. Push-to-open-System. Sistema Push.
-  Water resistant. Wasserabweisend. Indrorepellente.

LINE HANDLE

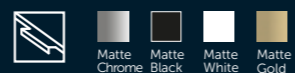

BEND HANDLE



LANDES MODULAR 120

- 112 24 060 BN Landes Module 2 Drawers 60 / Hohlmodul 2 Schubladen / Modulo 2 Cassetti
- 432 00 000 Special Drawer 60 without Siphon Cutout Lid / Spezialschublade 60 ohne Siphonaussparung / Cassetto Speciale 60 senza salva sifone
- 550 01 123 Onix New (60+60) Right / Rechts / Destra
- 239 02 090 Soul Black
- 112 24 337 BN Landes Tall Left Natural Oak / Hoch Links / Alto Sinistra
- 112 24 505 Shelf Horizontal Natural Oak / Horizontales Regal / Scaffale Orizzontale
- 112 45 520 Shelf L Anthracite / Regal L / Scaffale L
- 412 02 810 Kudo Black

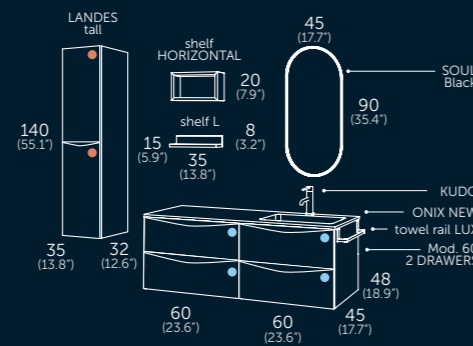

FURNITURE

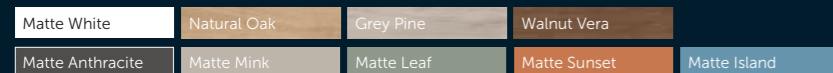

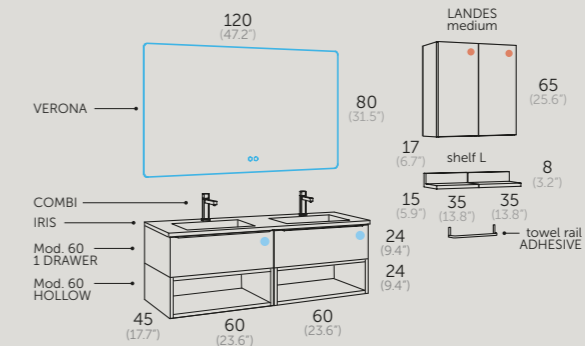

## LANDES MODULAR 120

- 112 35 063 LC Landes Module 1 Drawer 60 / Modul 1 Schublade / Modulo 1 Cassetto
- 112 84 065 Landes Module Hollow 60 / Hohlmodul / Modulo Cavo
- 536 19 122 Iris 2s Mink
- 246 00 120 Verona
- 112 35 435 Landes Medium White / Mittel / Medio
- 112 74 520 Shelf L Mink / Regal L / Scaffale L
- 416 00 037 Towel rail Adhesive 3M Chrome / Selbstklebender Handtuchhalter 3M / Porta asciugamani adesivo 3M
- 412 19 803 Combi Full Color Mink



- Metal interior drawers. Metallizerleiste. Sistema di estrazione metallico.
- Total extraction. Vollauszug. Estrazione totale.
- Organizer unit. Utensilien Behälter. Organizzatore.
- Soft close. Soft-close-System. Chiusura ammortizzata.
- GRASS Grass sliding system. Körperschiene Grass. Guide Grass.
- Push to open. Push-to-open-System. Sistema Push.
- Water resistant. Wasserabweisend. Indirorepellente.
- Anti fog system. Anti-Beschlag-System. Sistema antiappannamento.
- Ambient light. Umgebungslicht. Luce ambiente.
- Intensity control. Intensitätsregler. Regolatore di intensità.
- Dual sensor On/Off-anti fog. Doppelter Sensorschalter. On/Off. Doppio sensore touch. On/Off. Antiappannante.

### LINE HANDLE



- Matte Chrome
- Matte Black
- Matte White
- Matte Gold

### BEND HANDLE



- Matte Chrome
- Matte Black

### FURNITURE

- |                  |             |            |              |
|------------------|-------------|------------|--------------|
| Matte White      | Natural Oak | Grey Pine  | Walnut Vera  |
| Matte Anthracite | Matte Mink  | Matte Leaf | Matte Sunset |
| Matte Island     |             |            |              |



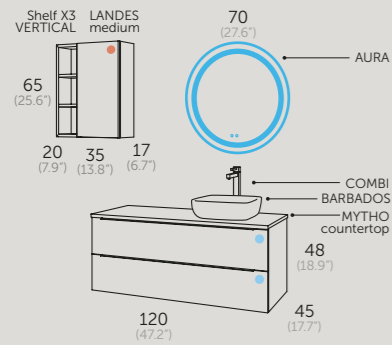









**LANDES 120 2 SINKS**

- 112 84 120 LN Landes 120 2s
- 583 77 037 Barbados Marquina Storm
- 532 77 120 Mytho Countertop Marquina Storm / Abdeckung / Piano
- 425 14 120 Reinforcement Bar / Waschtischplatten-Stabilisierung / Barra di rinforzo
- 250 02 070 Aura
- 112 84 435 Landes Medium Walnut Vera / Mittel / Medio
- 112 74 500 Shelf X3 Vertical Mink / Regal X3 Vertikal / Scaffale X3 Verticale
- 412 00 806 Combi Tall Black / Hoch / Alto



-  Metal interior drawers.  
Metallzierleiste.  
Sistema di estrazione metallico.
-  Total extraction.  
Vollauszug.  
Estrazione totale.
-  Organizer unit.  
Utensilien Behälter.  
Organizzatore.
-  Soft close.  
Soft-close-System.  
Chiusura ammortizzata.
-  GRASS  
Grass sliding system.  
Körpuschiene Grass.  
Guide Grass.
-  Push to open.  
Push-to-open-System.  
Sistema Push.
-  Water resistant.  
Wasserabweisend.  
Indirorepellente.
-  Anti fog system.  
Anti-Beschlag-System.  
Sistema antiappannamento.
-  Dual sensor On/Off-anti fog.  
Doppelter Sensorschalter, On/Off.  
Doppio sensore touch, On/Off.  
Antiappannante.

**LINE HANDLE**



**BEND HANDLE**



**FURNITURE**





## LANDES MODULAR 120

- 112 24 070 LB Landes Module 2 Drawers 70 / Hohlmodul 2 Schubladen / Modulo 2 Cassetti
- 112 24 034 LB Landes Module Double Drawer / Modul Doppelschublade / Modulo Doppio Cassetto
- 112 47 022 Landes Module Closed Shelves 20 / Modul für geschlossene Regale / Modulo Scaffali Chiusi
- 602 01 001 Ambar 1s (custom-made) / (Maßanfertigung) / (Su misura)
- 269 00 070 Rain
- 112 47 505 Shelf Horizontal Leaf / Horizontales Regal / Scaffale Orizzontale
- 112 24 520 Shelf L Natural Oak / Regal L / Scaffale L
- 412 24 800 Combi Chrome - Natural Oak

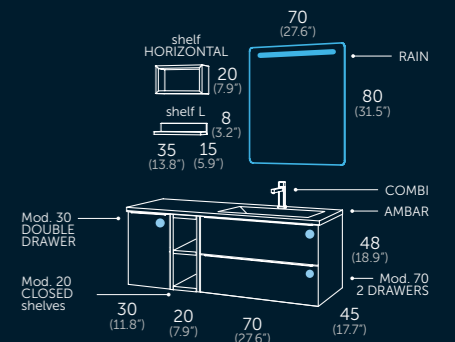

### FURNITURE

Matte White	Natural Oak	Grey Pine	Walnut Vera	
Matte Anthracite	Matte Mink	Matte Leaf	Matte Sunset	Matte Island

#### LINE HANDLE



Matte Chrome	Matte Black	Matte White	Matte Gold
--------------	-------------	-------------	------------

#### BEND HANDLE



Matte Chrome	Matte Black
--------------	-------------



Metal interior drawers. Metallzierleiste.  
Sistema di estrazione metallico.



Total extraction. Vollauszug.  
Estrazione totale.



Organizer unit. Utensilien Behälter.  
Organizzatore.



Soft close. Soft-close-System.  
Chiusura ammortizzata.



GRASS Grass sliding system. Körperschiene  
Grass. Guide Grass.



Water resistant. Wasserabweisend.  
Indrorepellente.



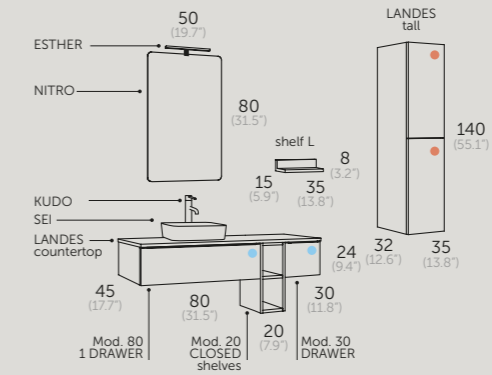

## LANDES MODULAR 130

- 112 37 083 LC Landes Module 1 Drawer 80 / Hohlmodul 1 Schublade / Modulo 1 Cassetto
- 112 37 033 LC Landes Module Drawer 30 / Modul Schublade/ Modulo Cassetto
- 112 45 022 Landes Module Closed Shelves 20 / Modul Für Geschlossene Regale / Modulo Scaffali Chiusi
- 112 37 213 Landes Countertop / Abdeckung / Piano
- 425 14 080 Reinforcement Bar 80 / Waschtischplatten-Stabilisierung / Barra di rinforzo
- 530 01 006 Sei
- 241 00 050 Nitro
- 400 00 121 Esther 30
- 112 37 336 LC Landes Tall Right Grey Pine / Hoch Rechts / Alto Destra
- 112 45 520 Shelf L Anthracite / Regal L / Scaffale L
- 412 04 815 Kudo Tall Brushed Steel / Hoch / Alto



- Metal interior drawers. Metallzierleiste. Sistema di estrazione metallico.
- Total extraction. Völlauszug. Estrazione totale.
- Organizer unit. Utensilien Behälter. Organizzatore.
- Soft close. Soft-close-System. Chiusura ammortizzata.
- GRASS Grass sliding system. Körperschiene Grass. Guide Grass.
- Soft close. Soft-close-System. Chiusura ammortizzata.
- Push to open. Push-to-open-System. Sistema Push.
- Water resistant. Wasserabweisend. Indrorepellente.

### LINE HANDLE



- Matte Chrome
- Matte Black
- Matte White
- Matte Gold

### BEND HANDLE











- Matte Chrome
- Matte Black

### FURNITURE

- |                  |             |            |              |
|------------------|-------------|------------|--------------|
| Matte White      | Natural Oak | Grey Pine  | Walnut Vera  |
| Matte Anthracite | Matte Mink  | Matte Leaf | Matte Sunset |
|                  |             |            | Matte Island |



-  Metal interior drawers. Metallzierleiste. Sistema di estrazione metallico.
-  Total extraction. Vollauszug. Estrazione totale.
-  Organizer unit. Utensilien Behälter. Organizzatore.
-  Soft close. Soft-close-System. Chiusura ammortizzata.
-  GRASS Grass sliding system. Korpusschiene Grass. Guide Grass.
-  Soft close. Soft-close-System. Chiusura ammortizzata.
-  Push to open. Push-to-open-System. Sistema Push.
-  Water resistant. Wasserabweisend. Indrorepellente.
-  Anti fog system. Anti-Beschlag-System. Sistema antiappannamento.
-  Ambient light. Umgebungslicht. Luce ambiente.
-  Intensity control. Intensitätsregler. Regolatore di intensità.
-  Dual sensor On/Off-anti fog. Doppelter Sensorschalter. On/Off. Doppio sensore di con tatto. On/Off. Antiappannante.

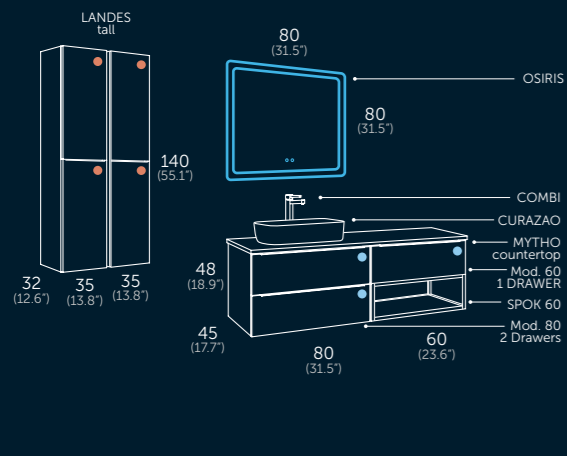

## LANDES MODULAR 140

- 112 45 080 LN Landes Module 2 Drawers 80 / Hohlmodul 2 Schubladen / Modulo 2 Cassetti
- 112 45 064 LN Landes Module 1 Drawer without siphon saver 60 / Modul 1 Schublade ohne Siphonassparung 60 / Modulo 1 cassetto senza salva sifone 60
- 165 45 060 Spok 60
- 532 95 140 Mytho Countertop Pure Cement / Abdeckung / Piano
- 425 14 080 Reinforcement Bar 80 / Waschtischplatten-Stabilisierung / Barra di rinforzo
- 585 95 034 Curazao Pure Cement
- 211 03 080 Osiris Anthracite
- 112 45 336 LN Landes Tall Right Anthracite / Hoch Rechts / Alto Destra
- 112 45 337 LN Landes Tall Left Anthracite / Hoch Links / Alto Sinistra
- 412 00 805 Combi Tall Chrome / Hoch / Alto

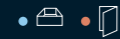

### LINE HANDLE

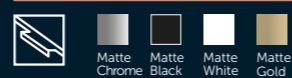

### BEND HANDLE



### FURNITURE

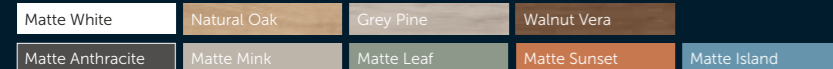

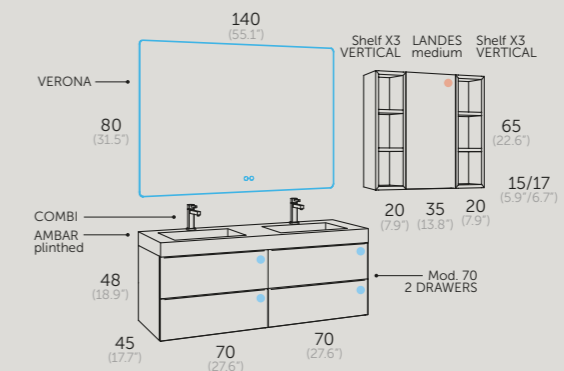

### LANDES MODULAR 140

- 112 24 070 LG Landes Module 2 Drawers 70 / Hohlmodul 2 Schubladen / Modulo 2 Cassetti
- 524 01 142 Ambar Pinthed 2s / Waschbecken / Lavabo con gonna Verona
- 112 24 435 Landes Medium Natural Oak / Mittel / Medio
- 112 35 500 Shelf X3 Vertical White / Regal X3 Vertikal / Scaffale X3 Verticale
- 412 00 802 Combi Gold



- Metal interior drawers. Metallzierleiste. Sistema di estrazione metallico.
- Total extraction. Vollauszug. Estrazione totale.
- Organizer unit. Utensilien Behälter. Organizzatore.
- Soft close. Soft-close-System. Chiusura ammortizzata.
- GRASS Grass sliding system. Körperschiene Grass. Guide Grass.
- Push to open. Push-to-open-System. Sistema Push.
- Water resistant. Wasserabweisend. Indrorepellente.
- Anti fog system. Anti-Beschlag-System. Sistema antiappannamento.
- Ambient light. Umgebungslicht. Luce ambiente.
- Intensity control. Intensitätsregler. Regolatore di intensità.
- Dual sensor On/Off-anti fog. Doppelter Sensorschalter. On/Off. Doppio sensore touch. On/Off. Antiappannante.

**LINE HANDLE**

	Matte Chrome	Matte Black	Matte White	Matte Gold

**BEND HANDLE**

	Matte Chrome	Matte Black

**FURNITURE**

Matte White	Natural Oak	Grey Pine	Walnut Vera	
Matte Anthracite	Matte Mink	Matte Leaf	Matte Sunset	Matte Island

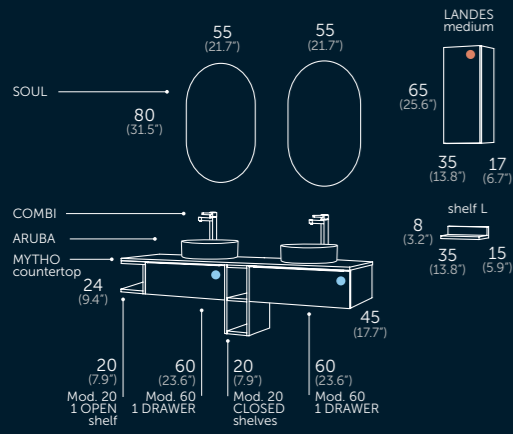

## LANDES MODULAR 160

- 112 35 063 BC Landes Module 1 Drawer 60 / Hohlmodul 1 Schublade / Modulo 1 Cassetto
- 112 47 022 Landes Module Closed Shelves 20 / Modul Für Geschlossene Regale 20 / Modulo Scaffali Chiusi 20
- 112 47 026 Landes Module 1 Open Shelf / Hohlmodul 2 Offene Regale / Modulo 2 Scaffali Aperti
- 532 76 999 Mytho Countertop (custom-made) Carrara / Abdeckung / Piano
- 425 14 060 Reinforcement Bar 60 / Waschtischplatten-Stabilisierung / Barra di rinforzo
- 581 76 037 Aruba Carrara
- 239 00 080 Soul
- 112 35 435 Landes Medium White / Mittel / Medio
- 112 47 520 Shelf L Leaf / Regal L / Scaffale L
- 412 00 805 Combi Tall Chrome / Hoch / Alto



Metal interior drawers. Metallzierleiste.  
Sistema di estrazione metallico.



Total extraction. Vollauszug.  
Estrazione totale.



Organizer unit. Utensilien Behälter.  
Organizzatore.



Soft close. Soft-close-System.  
Chiusura ammortizzata.



Grass sliding system. Korpuschiene  
Grass. Guide Grass.



Push to open. Push-to-open-System.  
Sistema Push.



Water resistant. Wasserabweisend.  
Indrorepellente.

### LINE HANDLE



Matte Chrome Matte Black Matte White Matte Gold

### BEND HANDLE



Matte Chrome Matte Black

### FURNITURE

Matte White	Natural Oak	Grey Pine	Walnut Vera
Matte Anthracite	Matte Mink	Matte Leaf	Matte Sunset
			Matte Island





-  Metal interior drawers.  
Metallzierleiste.  
Sistema di estrazione metallico.
-  Total extraction.  
Vollauszug.  
Estrazione totale.
-  Organizer unit.  
Utensilien Behälter.  
Organizzatore.
-  Soft close.  
Soft-close-System.  
Chiusura ammortizzata.
-  GRASS  
Grass sliding system.  
Körpuschiene Grass.  
Guide Grass.
-  Soft close.  
Soft-close-System.  
Chiusura ammortizzata.
-  Push to open.  
Push-to-open-System.  
Sistema Push.
-  Water resistant.  
Wasserabweisend.  
Indrorepellente.
-  Anti fog system.  
Anti-Beschlag-System.  
Sistema antiappannamento.
-  Ambient light.  
Umgebungslicht.  
Luce ambiente.
-  Intensity control.  
Intensitätsregler.  
Regolatore di intensità.
-  Dual sensor On/Off-anti fog.  
Doppelter Sensorschalter. On/Off.  
Antiappannante.

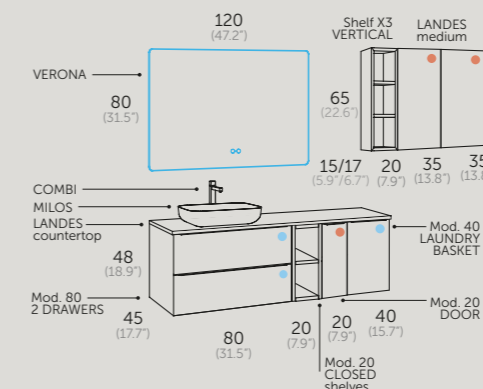

## LANDES MODULAR 160

- 112 37 080 LB Landes Module 2 Drawers 80 / Hohlmodul 2 Schubladen / Modulo 2 Cassetti
- 112 49 022 Landes Module Closed Shelves 20 / Modul Für Geschlossene Regale / Modulo Scaffali Chiusi
- 112 37 020 LB Landes Module Puerta 20 / Türmodul / Modulo Porta
- 112 37 042 LB Landes Module Laundry Basket / Modul Wäschkorb / Modulo Portabiancheria
- 112 37 216 Landes Countertop 160 / Abdeckung / Piano
- 425 14 080 Reinforcement Bar 80 / Waschtischplatten-Stabilisierung / Barra di rinforzo
- 509 01 052 Milos
- 246 00 120 Verona
- 112 37 435 Landes Medium Grey Pine / Mittel / Medio
- 112 49 500 Shelf X3 Vertical Island / Vertikales X3 Regal / Scaffale X3 Verticale
- 412 06 805 Combi Tall Chrome - White / Hoch / Alto



### LINE HANDLE

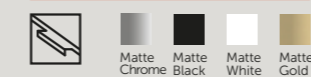

### BEND HANDLE



### FURNITURE



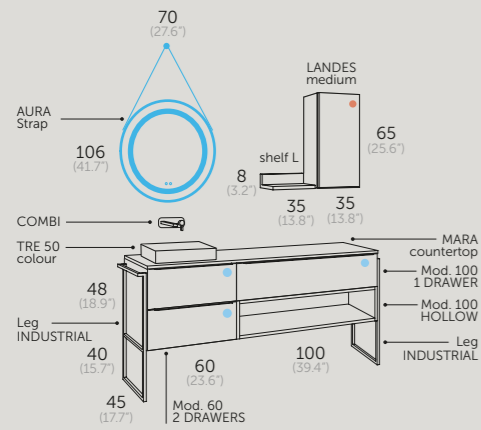

## LANDES MODULAR 160

- 112 24 060 LN Landes Module 2 Cajones 60 / Modul 2 Schubladen / Modulo 2 Cassetti
- 112 24 104 LN Landes Module 1 Cajón 100 without siphon saver / Modul 1 Schublade 100 ohne Siphonaussparung / Modulo 1 Cassetto 100 senza salva sifone
- 112 47 105 Landes Module Hollow 100 / Hohlmodul / Modulo Cavo
- 412 02 756 Pata Industrial with towel rail / Mit Handtuchhalter / Con Porta Asciugamani
- 412 02 754 Pata Industrial without towel rail / Ohne Handtuchhalter / Senza Porta Asciugamani
- 542 25 160 Mara Countertop Leaf / Abdeckung / Piano
- 425 14 060 Reinforcement Bar 60 / Waschtischplatten-Stabilisierung / Barra di rinforzo
- 535 25 035 Tre 50 Colour Leaf
- 251 02 070 Aura Strap
- 112 24 435 Landes Medium Natural Oak / Mittel / Medio
- 112 24 520 Shelf L Natural Oak / Regal L / Scaffale L
- 412 02 808 Combi Wall-Mounted Black



 Metal interior drawers.  
Metallzierleiste.  
Sistema di estrazione metallico.

 Push to open.  
Push-to-open-System.  
Sistema Push.

 Total extraction.  
Vollauszug.  
Estrazione totale.

 Resistant to water.  
Wasserabweisend.  
Indiropellente.

 Organizer unit.  
Utensilien Behälter.  
Organizzatore.

 Anti fog system.  
Anti-Beschlag-System.  
Sistema antiappannamento.

 Soft close.  
Soft-close-System.  
Chiusura ammortizzata.

 Dual sensor On/Off-anti fog.  
Doppelter Sensorschalter. On/Off.  
Doppio sensore touch. On/Off.  
Antiappannante.

 Grass sliding system.  
Korpusschiene Grass.  
Guide Grass.

### LINE HANDLE

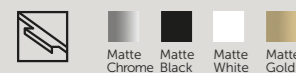

### BEND HANDLE





### FURNITURE







 Metal interior drawers. Metallzierleiste.  
Sistema di estrazione metallico.

 Total extraction. Vollauszug.  
Estrazione totale.

 Organizer unit. Utensilien Behälter.  
Organizzatore.

 Soft close. Soft-close-System.  
Chiusura ammortizzata.

 GRASS  
Grass sliding system. Korpuschiene  
Grass. Guide Grass.

 SOFT  
Soft close. Soft-close-System.  
Chiusura ammortizzata.

 Water resistant. Wasserabweisend.  
Indrorepellente.

## LANDES MODULAR 172

- 112 84 121 LN Landes Module 2 Drawers 120 1s / Hohlmodul 2 Schubladen / Modulo 2 Cassetti
- 112 48 029 Landes Module Chamfer 25 / Fasenmodul / Modulo di Smussatura
- 112 84 027 LN Landes Module Door 20 f24 / Türmodul / Modulo P orta
- 112 84 540 Landes Strip 7 cm / Streifen / Striscia
- 642 06 000 Mara Countertop (custom-made + cut) White / Abdeckung / Piano
- 425 14 120 Reinforcement Bar 120 / Waschtischplatten-Stabilisierung / Barra di rinforzo
- 581 06 037 Aruba White
- 241 00 120 Nitro
- 112 84 510 Shelf Vertical Walnut Vera / Vertikales Regal / Scaffale Verticale
- 112 48 510 Shelf Vertical Sunset / Vertikales Regal / Scaffale Verticale
- 412 02 808 Combi Wall-Mounted Black

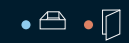
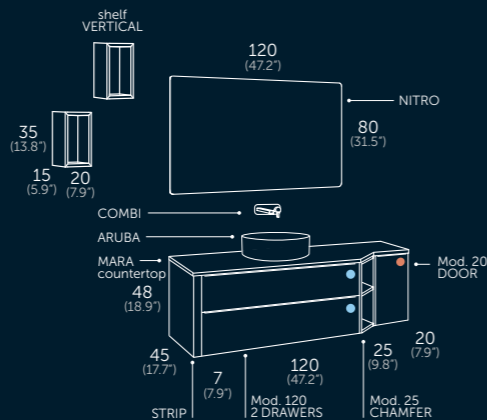

### BEND HANDLE



### LINE HANDLE

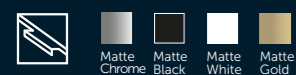

### FURNITURE

Matte White	Natural Oak	Grey Pine	Walnut Vera
Matte Anthracite	Matte Mink	Matte Leaf	Matte Sunset
			Matte Island



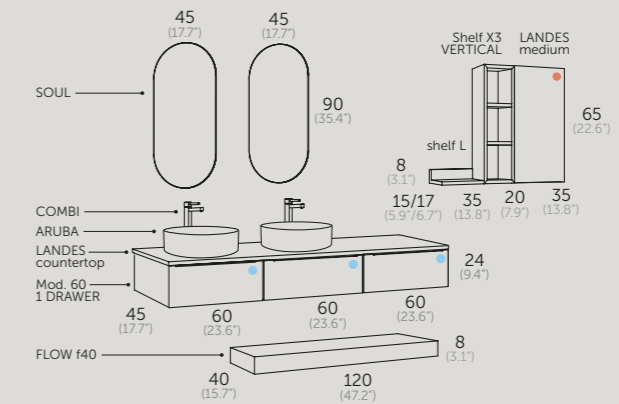





### LANDES MODULAR 180

- 112 24 063 LC Landes Module 1 Drawer 60 / Modul 1 Schublade 60 / Modulo 1 Cassetto 60
- 112 24 064 LC Landes Module 1 Drawer 60 without siphon saver / Modul 1 Schublade 60 ohne Siphonaussparung / Modulo 1 Cassetto 60 senza salvasifone
- 138 74 121 Flow 120 f40
- 112 24 218 Landes Countertop / Abdeckung / Piano
- 425 14 060 Reinforcement Bar 60 / Waschtischplatten-Stabilisierung / Barra di rinforzo
- 581 19 037 Aruba Mink
- 239 00 090 Soul
- 112 24 435 Landes Medium Natural Oak / Mittel / Medio
- 112 74 500 Shelf X3 Vertical Mink / Regal X3 Verticale / Scaffale X3 Verticale
- 112 48 520 Shelf L Sunset / Regal L / Scaffale L
- 412 08 804 Combi Tall Full Color Sunset / Hoch / Alto





-  Metal interior drawers. Metallzierleiste. Sistema di estrazione metallico.
-  Total extraction. Vollauszug. Estrazione totale.
-  Organizer unit. Utensilien Behälter. Organizzatore.
-  Soft close. Soft-close-System. Chiusura ammortizzata.
-  GRASS Grass sliding system. Korpuschiene Grass. Guide Grass.
-  Push to open. Push-to-open-System. Sistema Push.
-  Water resistant. Wasserabweisend. Indrorepellente.

**LINE HANDLE**

				
	Matte Chrome	Matte Black	Matte White	Matte Gold

**BEND HANDLE**

		
	Matte Chrome	Matte Black

**FURNITURE**

				
Matte White	Natural Oak	Grey Pine	Walnut Vera	
				
Matte Anthracite	Matte Mink	Matte Leaf	Matte Sunset	Matte Island



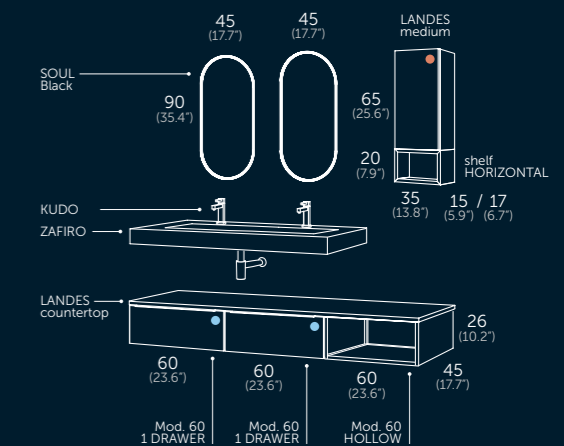

## LANDES MODULAR 180

- 112 35 064 LN Landes Module 1 Drawer 60 without siphon saver / Modul 1 Schublade 60 ohne Siphonaussparung / Modulo 1 Cassetto 60 senza salvafidone
- 112 47 065 Landes Module Hollow 60 / Hohlmodul / Modulo Cavo
- 112 37 218 Landes Countertop / Abdeckung / Piano
- 531 01 122 Zafiro 120 2 taps / Armaturen / Rubinetti
- 410 02 101 Black Siphon / Siphon / Sifone
- 239 02 090 Soul Black
- 112 37 435 Landes Medium Grey Pine / Mittel / Medio
- 112 47 505 Estante Horizontal Leaf / Horizontales Regal / Scaffale Orizzontale
- 412 02 810 Kudo Black





 Metal interior drawers. Metallzierleiste. Sistema di estrazione metallico.

 Organizer unit. Utensilien Behälter. Organizzatore.

 **GRASS** Grass sliding system. Korpussschiene. Grass. Guide Grass.

 Water resistant. Wasserabweisend. Indrorepellente.

 Total extraction. Vollauszug. Estrazione totale.



 Soft close. Soft-close-System. Chiusura ammortizzata.

 Push to open. Push-to-open-System. Sistema Push.

### FURNITURE

- Matte White
- Natural Oak
- Grey Pine
- Walnut Vera
- Matte Anthracite
- Matte Mink
- Matte Leaf
- Matte Sunset
- Matte Island

### LINE HANDLE

-  Matte Chrome
-  Matte Black
-  Matte White
-  Matte Gold

### BEND HANDLE

-  Matte Chrome
-  Matte Black

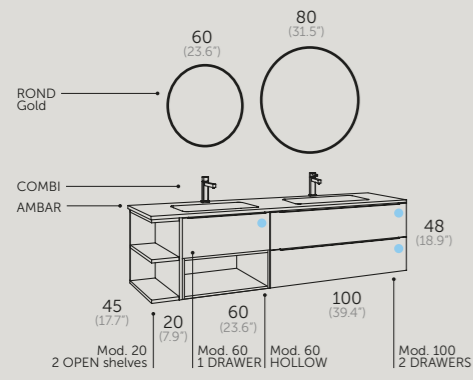

## LANDES MODULAR 180

- 112 84 100 LG Landes Module 2 Drawers 100 / Hohlmodul 2 Schubladen / Modulo 2 Cassetti
- 112 84 063 LG Landes Module 1 Drawer 60 / Hohlmodul 1 Schublade / Modulo Cavo 1 Cassetto
- 112 74 065 Landes Module Hollow 60 / Hohlmodul / Modulo Cavo
- 112 84 025 Landes Module 2 Open Shelves / Hohlmodul 2 offene Regale / Modulo 2 Scaffali Aperti
- 602 01 002 Ambar 2s (custom-made) / (Maßanfertigung) / (Su misura)
- 244 72 060 Rond Gold 60
- 244 72 080 Rond Gold 80
- 412 00 802 Combi Gold



- Metal interior drawers.  
Metallzierleiste.  
Sistema di estrazione metallico.
- Total extraction.  
Vollauszug.  
Estrazione totale.
- Organizer unit.  
Utensilien Behälter.  
Organizzatore.
- Soft close.  
Soft-close-System.  
Chiusura ammortizzata.
- GRASS  
Grass sliding system.  
Korpusschiene Grass.  
Guide Grass.
- Water resistant.  
Wasserabweisend.  
Indrorepellente.

### LINE HANDLE

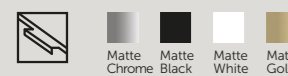

### BEND HANDLE



### FURNITURE

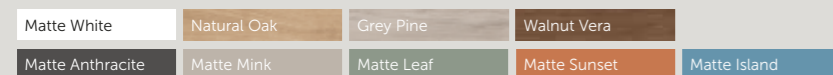



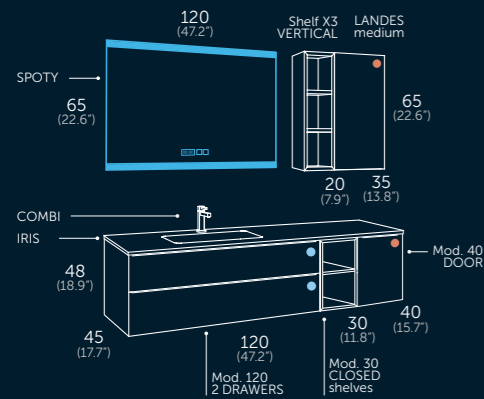



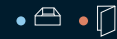

## LANDES MODULAR 190

112 45 121 LC	Landes Module 2 Drawers 120 1s / Hohlmodul 2 Schubladen / Modulo 2 Cassetti
112 47 032	Landes Module Closed Shelves 30 / Modul Für Geschlossene Regale / Modulo Scaffali Chiusi
112 45 040 LC	Landes Module Door 40 / Türmodul / Modulo Porta
650 25 001	Iris 1s (custom-made) Leaf / (Maßanfertigung) / (Su misura)
267 00 120	Spoty
112 45 435	Landes Medium Anthracite / Mittel / Medio
112 47 500	Shelf X3 Vertical Leaf / Regal X3 Vertikal / Scaffale X3 Verticale
412 03 803	Combi Full Color Anthracite





 Metal interior drawers. Metallzierleiste.  
Sistema di estrazione metallico.

 Anti fog system. Anti-Beschlag-System.  
Sistema antiappannamento.

 Total extraction. Vollauszug.  
Estrazione totale.

 Ambient light. Umgebungslicht.  
Luce ambiente.

 Organizer unit. Utensilien Behälter.  
Organizzatore.

 Digital clock. Digitaluhr.  
Orologio digitale.

 Soft close. Soft-close-System.  
Chiusura ammortizzata.

 Dual sensor On/Off-anti fog. Doppelter  
Sensorschalter. On/Off. Doppio sensore  
di con ratto. On/Off. Antiappannante.

 GRASS Grass sliding system. Korpusschiene  
Grass. Guide Grass.

 Push to open. Push-to-open-System.  
Sistema Push.

 Water resistant. Wasserabweisend.  
Indrorepellente.

### LINE HANDLE



### BEND HANDLE



### FURNITURE

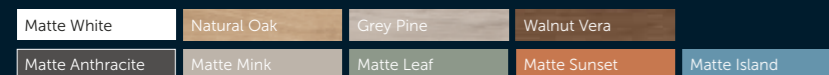

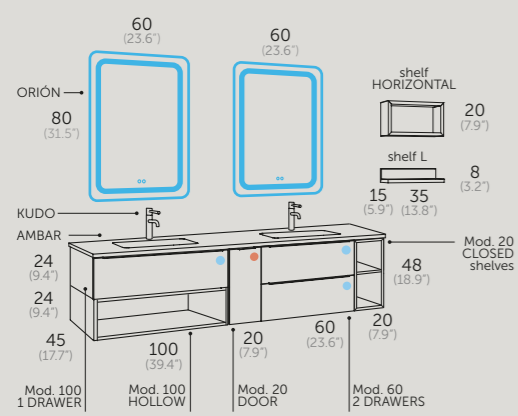

## LANDES MODULAR 200

- 112 24 103 LN Landes Module 1 Drawer 100 / Hohlmodul 1 Schublade / Modulo 1 Cassetto
- 112 74 105 Landes Module Hollow 100 / Hohlmodul / Modulo Cavo
- 112 24 020 LN Landes Module Door 20 / Türmodul / Modulo Porta
- 112 24 060 LN Landes Module 2 Drawers 60 / Hohlmodul 2 Schubladen / Modulo 2 Cassetti
- 112 74 022 Landes Closed Shelves 20 / Modul für geschlossene Regale / Modulo scaffali Chiusi
- 602 01 002 Ambar 2s (custom-made) / (Maßanfertigung) / (Su misura)
- 210 01 060 Orión
- 112 24 505 Shelf Horizontal Natural Oak / Horizontales Regal / Scaffale Orizzontale
- 112 74 520 Shelf L Mink / Regal L / Scaffale L
- 412 02 810 Kudo Black



### FURNITURE

Matte White	Natural Oak	Grey Pine	Walnut Vera
Matte Anthracite	Matte Mink	Matte Leaf	Matte Sunset
			Matte Island

### LINE HANDLE

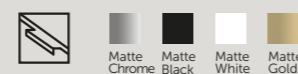

### BEND HANDLE



Metal interior drawers.  
Metallzierleiste.  
Sistema di estrazione metallico.



Organizer unit.  
Utensilien Behälter.  
Organizzatore.



GRASS  
Grass sliding system.  
Korpusschiene Grass.  
Guida Grass.



Anti fog system.  
Anti-Beschlag-System.  
Sistema antiappannamento.



Intensity control.  
Intensitätsregler.  
Regolatore di intensità.



Total extraction.  
Vollauszug.  
Estrazione totale.



Soft close.  
Soft-close-System.  
Chiusura ammortizzata.



Water resistant.  
Wasserabweisend.  
Indrorepellente.



Ambient light.  
Umgebungslicht.  
Luce ambiente.



Dual sensor On/Off-anti fog.  
Doppelter Sensorschalter On/Off.  
Doppio sensore touch On/Off.  
Antiappannante.

### LANDES 60 (23.62")

48 (18.9") 45 (17.7") 60 (23.6")

Finishes Reference  
 ● Matte White 112 35 060 (XX)  
 ● Natural Oak 112 24 060 (XX)  
 ● Grey Pine 112 37 060 (XX)  
 ● Walnut Vera 112 84 060 (XX)  
 ● Matte Anthracite 112 45 060 (XX)

Replace XX with the model reference and handle finish:  
 Ersetze XX durch die Modellreferenz und Griffausführung:  
 Sostituisci XX con il riferimento del modello e la finitura della maniglia:

LINE ● Chrome (LC) ● Black (LN) ● White (LB) ● Gold (LG)  
 BEND ● Chrome (BC) ● Black (BN)

### LANDES 70 (27.55")

48 (18.9") 45 (17.7") 70 (27.6")

Finishes Reference  
 ● Matte White 112 35 070 (XX)  
 ● Natural Oak 112 24 070 (XX)  
 ● Grey Pine 112 37 070 (XX)  
 ● Walnut Vera 112 84 070 (XX)  
 ● Matte Anthracite 112 45 070 (XX)

Replace XX with the model reference and handle finish:  
 Ersetze XX durch die Modellreferenz und Griffausführung:  
 Sostituisci XX con il riferimento del modello e la finitura della maniglia:

LINE ● Chrome (LC) ● Black (LN) ● White (LB) ● Gold (LG)  
 BEND ● Chrome (BC) ● Black (BN)

### LANDES 80 (31.49")

48 (18.9") 45 (17.7") 80 (31.5")

Finishes Reference  
 ● Matte White 112 35 080 (XX)  
 ● Natural Oak 112 24 080 (XX)  
 ● Grey Pine 112 37 080 (XX)  
 ● Walnut Vera 112 84 080 (XX)  
 ● Matte Anthracite 112 45 080 (XX)

Replace XX with the model reference and handle finish:  
 Ersetze XX durch die Modellreferenz und Griffausführung:  
 Sostituisci XX con il riferimento del modello e la finitura della maniglia:

LINE ● Chrome (LC) ● Black (LN) ● White (LB) ● Gold (LG)  
 BEND ● Chrome (BC) ● Black (BN)

### LANDES 100 (39.37")

48 (18.9") 45 (17.7") 100 (39.4")

Finishes Reference  
 ● Matte White 112 35 100 (XX)  
 ● Natural Oak 112 24 100 (XX)  
 ● Grey Pine 112 37 100 (XX)  
 ● Walnut Vera 112 84 100 (XX)  
 ● Matte Anthracite 112 45 100 (XX)

Replace XX with the model reference and handle finish:  
 Ersetze XX durch die Modellreferenz und Griffausführung:  
 Sostituisci XX con il riferimento del modello e la finitura della maniglia:

LINE ● Chrome (LC) ● Black (LN) ● White (LB) ● Gold (LG)  
 BEND ● Chrome (BC) ● Black (BN)

### LANDES 120 1S (47.24")

48 (18.9") 45 (17.7") 120 (47.2")

Finishes Reference  
 ● Matte White 112 35 121 (XX)  
 ● Natural Oak 112 24 121 (XX)  
 ● Grey Pine 112 37 121 (XX)  
 ● Walnut Vera 112 84 121 (XX)  
 ● Matte Anthracite 112 45 121 (XX)

Replace XX with the model reference and handle finish:  
 Ersetze XX durch die Modellreferenz und Griffausführung:  
 Sostituisci XX con il riferimento del modello e la finitura della maniglia:

LINE ● Chrome (LC) ● Black (LN) ● White (LB) ● Gold (LG)  
 BEND ● Chrome (BC) ● Black (BN)

### LANDES 120 2S (47.24")

Includes a siphon saver countertop.  
 48 (18.9") 45 (17.7") 120 (47.2")

Finishes Reference  
 ● Matte White 112 35 120 (XX)  
 ● Natural Oak 112 24 120 (XX)  
 ● Grey Pine 112 37 120 (XX)  
 ● Walnut Vera 112 84 120 (XX)  
 ● Matte Anthracite 112 45 120 (XX)

Replace XX with the model reference and handle finish:  
 Ersetze XX durch die Modellreferenz und Griffausführung:  
 Sostituisci XX con il riferimento del modello e la finitura della maniglia:

LINE ● Chrome (LC) ● Black (LN) ● White (LB) ● Gold (LG)  
 BEND ● Chrome (BC) ● Black (BN)

<b>ONIX NEW</b> ceramic Reference ● Glossy White 550 01 060 ● Matte Colour 552 XX 060	<b>AMBAR / MARA</b> Reference ● Solid Surface 506 01 060 ● Resin Colour 540 XX 060	<b>ZEN / IRIS</b> Reference ● Solid Surface 555 01 060 ● Resin Colour 536 XX 060	<b>QUATTRO</b> ceramic Reference ● Glossy White 522 01 060	<b>AMBAR / MARA</b> countertop Reference ● Solid Surface 508 01 060 ● Resin Colour 542 XX 060

<b>ONIX NEW</b> ceramic Reference ● Glossy White 550 01 070 ● Matte Colour 552 XX 070	<b>AMBAR / MARA</b> Reference ● Solid Surface 506 01 070 ● Resin Colour 540 XX 070	<b>ZEN / IRIS</b> Reference ● Solid Surface 555 01 070 ● Resin Colour 536 XX 070	<b>AMBAR / MARA</b> plinthed Reference ● Solid Surface 524 01 070 ● Resin Colour 541 XX 070	<b>AMBAR / MARA</b> countertop Reference ● Solid Surface 508 01 070 ● Resin Colour 542 XX 070

<b>ONIX NEW</b> ceramic Reference ● Glossy White 550 01 080 ● Matte Colour 552 XX 080	<b>AMBAR / MARA</b> Reference ● Solid Surface 506 01 080 ● Resin Colour 540 XX 080	<b>ZEN / IRIS</b> Reference ● Solid Surface 555 01 080 ● Resin Colour 536 XX 080	<b>QUATTRO</b> ceramic Reference ● Glossy White 522 01 080	<b>AMBAR / MARA</b> countertop Reference ● Solid Surface 508 01 080 ● Resin Colour 542 XX 080

<b>ONIX NEW</b> ceramic Reference ● Glossy White 550 01 100 ● Matte Colour 552 XX 100	<b>AMBAR / MARA</b> Reference ● Solid Surface 506 01 100 ● Resin Colour 540 XX 100	<b>ZEN / IRIS</b> Reference ● Solid Surface 555 01 100 ● Resin Colour 536 XX 100	<b>QUATTRO</b> ceramic Reference ● Glossy White 522 01 100	<b>AMBAR / MARA</b> countertop Reference ● Solid Surface 508 01 100 ● Resin Colour 542 XX 100

<b>ONIX NEW</b> ceramic Reference ● Glossy White 550 01 120	<b>AMBAR / MARA</b> Reference ● Solid Surface 506 01 120 ● Resin Colour 540 XX 120	<b>ZEN / IRIS</b> Reference ● Solid Surface 555 01 120 ● Resin Colour 536 XX 120	<b>AMBAR / MARA</b> plinthed Reference ● Solid Surface 524 01 120 ● Resin Colour 541 XX 120	<b>AMBAR / MARA</b> countertop Reference ● Solid Surface 508 01 120 ● Resin Colour 542 XX 120

<b>ONIX NEW</b> ceramic Reference ● Glossy White 550 01 122	<b>AMBAR / MARA</b> Reference ● Solid Surface 506 01 122 ● Resin Colour 540 XX 122	<b>ZEN / IRIS</b> Reference ● Solid Surface 555 01 122 ● Resin Colour 536 XX 122	<b>ONIX NEW</b> ceramic Reference ● Glossy White 550 01 121	<b>ONIX NEW</b> ceramic Reference ● Glossy White 550 01 123

● Replace the XX by the colour code. See page 447.  
 Ersetzen Sie XX durch den Farbcode. Siehe Seite 447.  
 Sostituire XX con il codice colore. Vedere pagina 447.

<b>SUN</b> Reference 204 00 060	<b>SOUL</b> Reference ● BLACK 239 02 090 ● GOLD 239 72 090	<b>RAIN LED</b> Reference 269 00 060	<b>ORIÓN / OSIRIS LED</b> Reference ● Solid Surface 210 01 060 ● Resin Colour 211 XX 060	<b>FLASH 60</b> cabinet Reference ● Aluminium 340 11 060 1 Door

<b>SUN</b> Reference 204 00 070	<b>SOUL</b> Reference ● BLACK 239 02 080 ● GOLD 239 72 080	<b>RAIN LED</b> Reference 269 00 070	<b>VERONA LED</b> Reference 246 00 070	<b>FLASH 70</b> cabinet Reference ● Aluminium 340 11 070 2 Doors

<b>SUN</b> Reference 204 00 080	<b>SOUL</b> Reference ● BLACK 239 02 100 ● GOLD 239 72 100	<b>RAIN LED</b> Reference 269 00 080	<b>ORIÓN / OSIRIS LED</b> Reference ● Solid Surface 210 01 080 ● Resin Colour 211 XX 080	<b>FLASH 80</b> cabinet Reference ● Aluminium 340 11 080 2 Doors

<b>SUN</b> Reference 204 00 100	<b>ROND</b> Reference ● BLACK 244 02 100 ● GOLD 244 72 100	<b>RAIN LED</b> Reference 269 00 100	<b>ORIÓN / OSIRIS LED</b> Reference ● Solid Surface 210 01 100 ● Resin Colour 211 XX 100	<b>SPOTY LED</b> Reference 267 00 100

<b>SUN</b> Reference 204 00 120	<b>NITRO</b> Reference 241 00 120	<b>RAIN LED</b> Reference 269 00 120	<b>COSMOS LED</b> Reference 270 00 120	<b>SPOTY LED</b> Reference 267 00 120

<b>SUN</b> Reference 204 00 050	<b>SOUL</b> Reference 239 00 090	<b>SKYLINE 120</b> cabinet Reference ● Matte White 341 35 120 ● Natural Oak 341 24 120 3 Doors	<b>COMBI</b> tap Reference ● Chrome 412 00 800 ● Black 412 00 801 ● Gold 412 00 802	<b>LUX 38</b> towel rail Reference ● Chrome 417 00 038 ● Black 417 02 038 ● White 417 27 038

### LANDES COUNTERTOP

Reinforcement Bar not included  
 Verstärkungsstange nicht enthalten  
 Barra di rinforzo non inclusa

cm	Matte White	Natural Oak	Grey Pine	Walnut Vera	Matte Anthracite
60	112 35 206	112 24 206	112 37 206	112 84 206	112 45 206
70	112 35 207	112 24 207	112 37 207	112 84 207	112 45 207
80	112 35 208	112 24 208	112 37 208	112 84 208	112 45 208
100	112 35 210	112 24 210	112 37 210	112 84 210	112 45 210
120	112 35 212	112 24 212	112 37 212	112 84 212	112 45 212

### REINFORCEMENT BAR ALUMINIUM

Its installation is necessary to prevent deformation of the countertop.  
 Seine Installation ist notwendig, um Verformungen der Arbeitsplatte zu verhindern.  
 La sua installazione è necessaria per prevenire la deformazione del piano di lavoro.

cm	Reference
60	425 14 060
70	425 14 070
80	425 14 080
100	425 14 100
120	425 14 120

### DRILLING SERVICE

Plan required. Ref: 435 00 050

<b>ROTTERDAM</b> ceramic Reference ● Glossy White 507 01 004 ● Matte Colour 535 XX 004	<b>MILOS/MASAI</b> Reference ● Solid Surface 509 01 052 ● Resin Colour 518 XX 051	<b>BARBADOS</b> resina deco Reference ● Carrara 583 76 037 ● Marquina Storm 583 77 037 ● Pure cement 583 95 037

### LANDES TALL

Finishes	Right	Left
● Matte White	112 35 336 (XX)	112 35 337 (XX)
● Natural Oak	112 24 336 (XX)	112 24 337 (XX)
● Grey Pine	112 37 336 (XX)	112 37 337 (XX)
● Walnut Vera	112 84 336 (XX)	112 84 337 (XX)
● Matte Anthracite	112 45 336 (XX)	112 45 337 (XX)

Replace XX with the model reference and handle finish:  
 Ersetze XX durch die Modellreferenz und Griffausführung:  
 Sostituisci XX con il riferimento del modello e la finitura della maniglia:

LINE ● Chrome (LC) ● Black (LN) ● White (LB) ● Gold (LG)  
 BEND ● Chrome (BC) ● Black (BN)

### LANDES MEDIUM

Finishes	Reference
● Matte White	112 35 435
● Natural Oak	112 24 435
● Grey Pine	112 37 435
● Walnut Vera	112 84 435
● Matte Anthracite	112 45 435

Reversible opening / Reversible Öffnung / Apertura reversibile

### SPECIAL DRAWER SPEZIALSCHUBLADE / CASSETTO SPECIALE

Check all the information on page 429. Konsultieren Sie alle Informationen auf Seite 429. Consulta tutte le informazioni nella pagina 429.

### OFFSET SIPHON CUTOUT

VERSCHIEBBARER SIPHON / SIFONE REGOLABILE  
 Ref: 432 00 001  
 Plan required. Not available for sizes 60 and 120 2s cm.  
 Plan erforderlich. Nicht verfügbar für die Maße 60 und 120 2s cm.  
 È necessario il disegno. Non disponibile per le misure 60 e 120 2s cm.

### WITHOUT SIPHON CUTOUT

OHNE SIPHON / SENZA SIFONE  
 Ref: 432 00 000

# LANDES MODULAR

MODULATION IDEAS / MODULATIONSIDEEN / IDEE DI MODULAZIONE



**60** (23.6")



**70** (27.6")

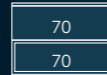

**80** (31.5")

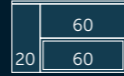
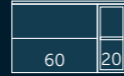
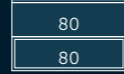
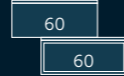

**90** (35.4")

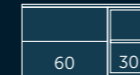
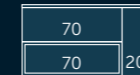
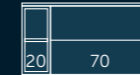
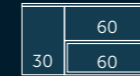
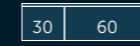

**100** (39.4")

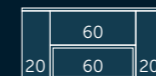
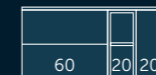
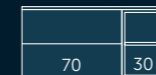
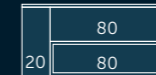
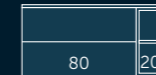
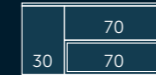
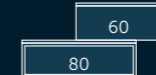
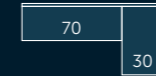

**110** (43.3")

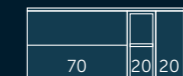
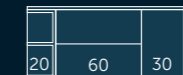
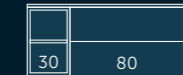
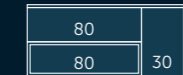
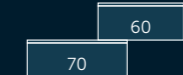
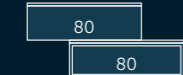
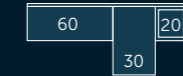

**120** (47.2")

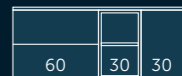
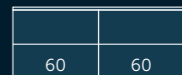
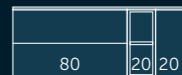
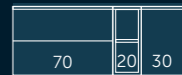
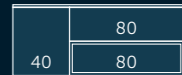
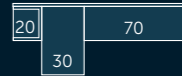

**130** (51.1")

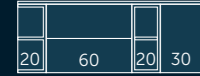
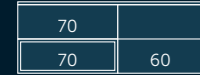
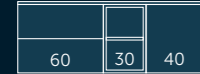
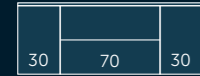
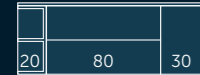
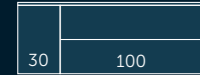
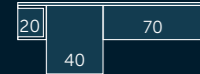

**140** (55.1")

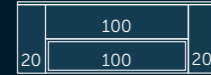
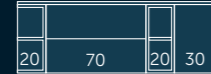
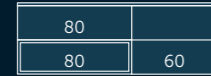
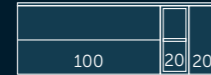
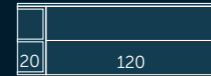
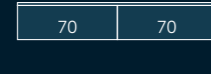

**150** (59")

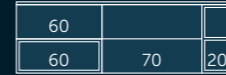
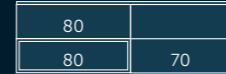
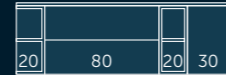
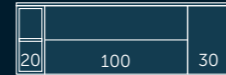
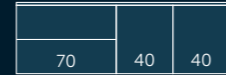
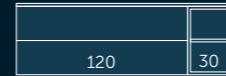
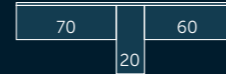

**160** (62.9")

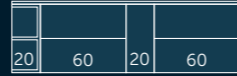
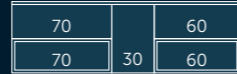
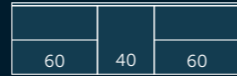
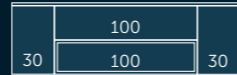
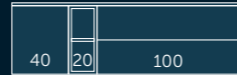
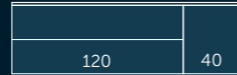

**170** (66.9")

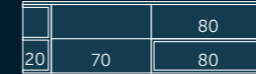
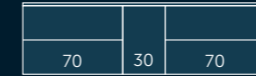
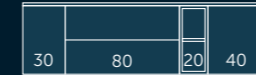
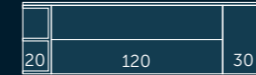
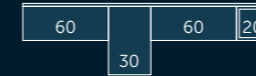

**180** (70.8")

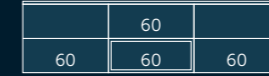
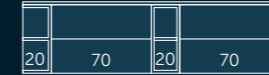
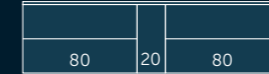
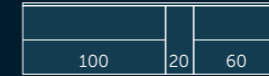
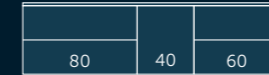
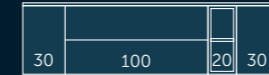
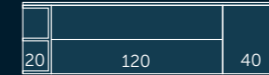

**190** (74.8")

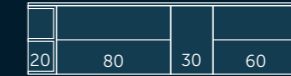
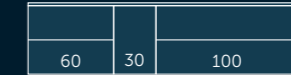
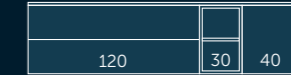
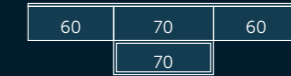
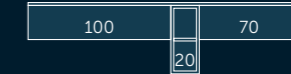

**200** (78.7")

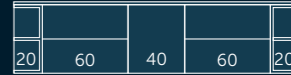
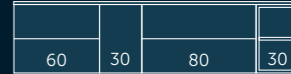
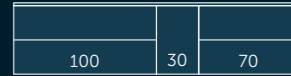
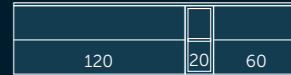
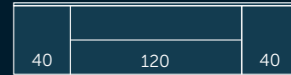
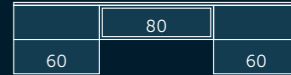

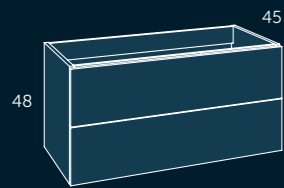

**MODULE 2 DRAWERS**  
 MODUL MIT 2 SCHUBLADEN  
 MODULO 2 CASSETTI

60 (23.6")	
Finishes	Reference
● Matte White	112 35 060 (XX)
● Natural Oak	112 24 060 (XX)
● Grey Pine	112 37 060 (XX)
● Walnut Vera	112 84 060 (XX)
● Matte Anthracite	112 45 060 (XX)



**MODULE 1 DRAWER**  
 MODUL 1 SCHUBLADE  
 MODULO 1 CASSETTO

60 (23.6")	
Finishes	Reference
● Matte White	112 35 063 (XX)
● Natural Oak	112 24 063 (XX)
● Grey Pine	112 37 063 (XX)
● Walnut Vera	112 84 063 (XX)
● Matte Anthracite	112 45 063 (XX)



**MODULE 1 DRAWER**  
 MODUL 1 SCHUBLADE  
 MODULO 1 CASSETTO

60 (23.6")	
Finishes	Reference
● Matte White	112 35 064 (XX)
● Natural Oak	112 24 064 (XX)
● Grey Pine	112 37 064 (XX)
● Walnut Vera	112 84 064 (XX)
● Matte Anthracite	112 45 064 (XX)



**MODULE HOLLOW**  
 HOHLMODUL  
 MODULO CAVO

60 (23.6")	
Finishes	Reference
● Matte White	112 35 065
● Natural Oak	112 24 065
● Grey Pine	112 37 065
● Walnut Vera	112 84 065
● Matte Anthracite	112 45 065
● Matte Mink	112 74 065
● Matte Leaf	112 47 065
● Matte Sunset	112 48 065
● Matte Island	112 49 065



REVERSIBLE  
**MODULE DOOR**  
 TÜRMODUL  
 MODULO PORTA

20 (7.9")	
Finishes	Reference
● Matte White	112 35 020 (XX)
● Natural Oak	112 24 020 (XX)
● Grey Pine	112 37 020 (XX)
● Walnut Vera	112 84 020 (XX)
● Matte Anthracite	112 45 020 (XX)

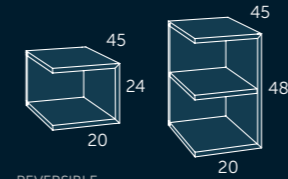

REVERSIBLE  
**MODULE OPEN SHELVES**  
 OFFENES REGALMODUL  
 MODULO A SCAFFALI APERTI

1 SHELF	
Finishes	Reference
● Matte White	112 35 026
● Natural Oak	112 24 026
● Grey Pine	112 37 026
● Walnut Vera	112 84 026
● Matte Anthracite	112 45 026
● Matte Mink	112 74 026
● Matte Leaf	112 47 026
● Matte Sunset	112 48 026
● Matte Island	112 49 026

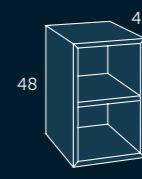

**MODULE CLOSED SHELVES**  
 MODUL FÜR GESCHLOSSENE REGALE  
 MODULO SCAFFALI CHIUSI

20 (7.9")	
Finishes	Reference
● Matte White	112 35 022
● Natural Oak	112 24 022
● Grey Pine	112 37 022
● Walnut Vera	112 84 022
● Matte Anthracite	112 45 022
● Matte Mink	112 74 022
● Matte Leaf	112 47 022
● Matte Sunset	112 48 022
● Matte Island	112 49 022

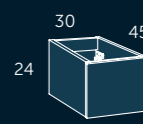

**MODULE DRAWER 30**  
 MODUL SCHUBLADE 30  
 MODULO CASSETTO 30

30 (11.8")	
Finishes	Reference
● Matte White	112 35 033 (XX)
● Natural Oak	112 24 033 (XX)
● Grey Pine	112 37 033 (XX)
● Walnut Vera	112 84 033 (XX)
● Matte Anthracite	112 45 033 (XX)

70 (27.6")	
Finishes	Reference
● Matte White	112 35 070 (XX)
● Natural Oak	112 24 070 (XX)
● Grey Pine	112 37 070 (XX)
● Walnut Vera	112 84 070 (XX)
● Matte Anthracite	112 45 070 (XX)

70 (27.6")	
Finishes	Reference
● Matte White	112 35 073 (XX)
● Natural Oak	112 24 073 (XX)
● Grey Pine	112 37 073 (XX)
● Walnut Vera	112 84 073 (XX)
● Matte Anthracite	112 45 073 (XX)

70 (27.6")	
Finishes	Reference
● Matte White	112 35 074 (XX)
● Natural Oak	112 24 074 (XX)
● Grey Pine	112 37 074 (XX)
● Walnut Vera	112 84 074 (XX)
● Matte Anthracite	112 45 074 (XX)

70 (27.6")	
Finishes	Reference
● Matte White	112 35 075
● Natural Oak	112 24 075
● Grey Pine	112 37 075
● Walnut Vera	112 84 075
● Matte Anthracite	112 45 075
● Matte Mink	112 74 075
● Matte Leaf	112 47 075
● Matte Sunset	112 48 075
● Matte Island	112 49 075

30 (11.8")	
Finishes	Reference
● Matte White	112 35 030 (XX)
● Natural Oak	112 24 030 (XX)
● Grey Pine	112 37 030 (XX)
● Walnut Vera	112 84 030 (XX)
● Matte Anthracite	112 45 030 (XX)

2 SHELVES	
Finishes	Reference
● Matte White	112 35 025
● Natural Oak	112 24 025
● Grey Pine	112 37 025
● Walnut Vera	112 84 025
● Matte Anthracite	112 45 025
● Matte Mink	112 74 025
● Matte Leaf	112 47 025
● Matte Sunset	112 48 025
● Matte Island	112 49 025

30 (11.8")	
Finishes	Reference
● Matte White	112 35 032
● Natural Oak	112 24 032
● Grey Pine	112 37 032
● Walnut Vera	112 84 032
● Matte Anthracite	112 45 032
● Matte Mink	112 74 032
● Matte Leaf	112 47 032
● Matte Sunset	112 48 032
● Matte Island	112 49 032

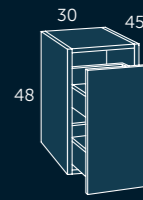

**MODULE DOUBLE DRAWER**  
 MODUL DOPPELSCHUBLADEN  
 MODULO DUE CASSETTI

80 (31.5")	
Finishes	Reference
● Matte White	112 35 080 (XX)
● Natural Oak	112 24 080 (XX)
● Grey Pine	112 37 080 (XX)
● Walnut Vera	112 84 080 (XX)
● Matte Anthracite	112 45 080 (XX)

80 (31.5")	
Finishes	Reference
● Matte White	112 35 083 (XX)
● Natural Oak	112 24 083 (XX)
● Grey Pine	112 37 083 (XX)
● Walnut Vera	112 84 083 (XX)
● Matte Anthracite	112 45 083 (XX)

80 (31.5")	
Finishes	Reference
● Matte White	112 35 084 (XX)
● Natural Oak	112 24 084 (XX)
● Grey Pine	112 37 084 (XX)
● Walnut Vera	112 84 084 (XX)
● Matte Anthracite	112 45 084 (XX)

80 (31.5")	
Finishes	Reference
● Matte White	112 35 085
● Natural Oak	112 24 085
● Grey Pine	112 37 085
● Walnut Vera	112 84 085
● Matte Anthracite	112 45 085
● Matte Mink	112 74 085
● Matte Leaf	112 47 085
● Matte Sunset	112 48 085
● Matte Island	112 49 085

40 (15.7")	
Finishes	Reference
● Matte White	112 35 040 (XX)
● Natural Oak	112 24 040 (XX)
● Grey Pine	112 37 040 (XX)
● Walnut Vera	112 84 040 (XX)
● Matte Anthracite	112 45 040 (XX)

20 - 35* (8.3 - 13.8")	
Finishes	Reference
● Matte White	112 35 000
● Natural Oak	112 24 000
● Grey Pine	112 37 000
● Walnut Vera	112 84 000
● Matte Anthracite	112 45 000
● Matte Mink	112 74 000
● Matte Leaf	112 47 000
● Matte Sunset	112 48 000
● Matte Island	112 49 000

30 (11.8")	
Finishes	Reference
● Matte White	112 35 034 (XX)
● Natural Oak	112 24 034 (XX)
● Grey Pine	112 37 034 (XX)
● Walnut Vera	112 84 034 (XX)
● Matte Anthracite	112 45 034 (XX)

100 (39.4")	
Finishes	Reference
● Matte White	112 35 100 (XX)
● Natural Oak	112 24 100 (XX)
● Grey Pine	112 37 100 (XX)
● Walnut Vera	112 84 100 (XX)
● Matte Anthracite	112 45 100 (XX)

100 (39.4")	
Finishes	Reference
● Matte White	112 35 103 (XX)
● Natural Oak	112 24 103 (XX)
● Grey Pine	112 37 103 (XX)
● Walnut Vera	112 84 103 (XX)
● Matte Anthracite	112 45 103 (XX)

100 (39.4")	
Finishes	Reference
● Matte White	112 35 104 (XX)
● Natural Oak	112 24 104 (XX)
● Grey Pine	112 37 104 (XX)
● Walnut Vera	112 84 104 (XX)
● Matte Anthracite	112 45 104 (XX)

120 1 CENTERED SINK (47.2")	
Finishes	Reference
● Matte White	112 35 121 (XX)
● Natural Oak	112 24 121 (XX)
● Grey Pine	112 37 121 (XX)
● Walnut Vera	112 84 121 (XX)
● Matte Anthracite	112 45 121 (XX)

120 2 SINKS (47.2")	
Finishes	Reference
● Matte White	112 35 120 (XX)
● Natural Oak	112 24 120 (XX)
● Grey Pine	112 37 120 (XX)
● Walnut Vera	112 84 120 (XX)
● Matte Anthracite	112 45 120 (XX)

Replace XX with the reference of the selected handle model and finish:  
 Ersetze XX durch die Referenz des gewählten Griffmodells und der Ausführung:  
 Sostituire XX con il riferimento del modello e della finitura della maniglia scelta:

**LINE HANDLE**

- Chrome (LC) White (LB)
- Black (LN) Gold (LG)

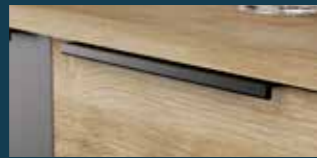

**BEND HANDLE**

- Chrome (BC) Black (BN)



**OPTIONAL SIPHON HOLE TRAY**  
 SIPHONLOCHABLAGE  
 COPERCHIO PER SALVASIFONE

Covers the siphon cutout space when no washbasin is installed.  
 Deckt die Siphonaussparung ab, wenn kein Waschtisch installiert ist.  
 Copre lo spazio del sifon trou quando non è installato alcun lavabo.

Reference  
 418 00 000



**MODULE LAUNDRY BASKET**  
 MODUL WÄSCHKORB  
 MODULO PORTABIANCHERIA

40 (15.7")	
Finishes	Reference
● Matte White	112 35 042 (XX)
● Natural Oak	112 24 042 (XX)
● Grey Pine	112 37 042 (XX)
● Walnut Vera	112 84 042 (XX)
● Matte Anthracite	112 45 042 (XX)

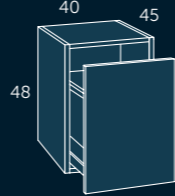

**MODULES**

**REDUCED DEPTH**



REVERSIBLE  
**MODULE DOOR**  
 TÜRMODUL / MODULO PORTA

20 (7.9")	
Finishes	Reference
● Matte White	112 35 027 (XX)
● Natural Oak	112 24 027 (XX)
● Grey Pine	112 37 027 (XX)
● Walnut Vera	112 84 027 (XX)
● Matte Anthracite	112 45 027 (XX)

30 (11.8")	
Finishes	Reference
● Matte White	112 35 037 (XX)
● Natural Oak	112 24 037 (XX)
● Grey Pine	112 37 037 (XX)
● Walnut Vera	112 84 037 (XX)
● Matte Anthracite	112 45 037 (XX)



REVERSIBLE From 45 to 24 cm  
**MODULE CHAMFER**  
 FASENMODUL  
 MODULO DI SMUSSATURA

25 (9.8")	
Finishes	Reference
● Matte White	112 35 029
● Natural Oak	112 24 029
● Grey Pine	112 37 029
● Walnut Vera	112 84 029
● Matte Anthracite	112 45 029
● Matte Mink	112 74 029
● Matte Leaf	112 47 029
● Matte Sunset	112 48 029
● Matte Island	112 49 029

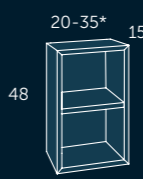

**MODULE PILLAR FILLER**  
 MODUL SÄULENFÜLLER  
 MODULO RABBOCCO DEL PILASTRO

20 - 35 (8.3 - 13.8")	
Finishes	Reference
● Matte White	112 35 005
● Natural Oak	112 24 005
● Grey Pine	112 37 005
● Walnut Vera	112 84 005
● Matte Anthracite	112 45 005

\*Custom-made shelf module, cm by cm.  
 Width: from 20 to 35 cm. Made to order.  
 \*Regalmodul nach Maß, cm-genaue Fertigung.  
 Breite: von 20 bis 35 cm. Auf Bestellung gefertigt.  
 \*Modulo scaffale su misura, realizzato cm per cm.  
 Larghezza: da 20 a 35 cm. Su ordinazione.



**STRIP**  
 STREIFEN  
 STRISCIA  
 6-20 (2.3" - 8")

6-20 (2.3" - 8")	
Finishes	Reference
● Matte White	112 35 540
● Natural Oak	112 24 540
● Grey Pine	112 37 540
● Walnut Vera	112 84 540
● Matte Anthracite	112 45 540

\*Custom-made shelf module, cm by cm.  
 Width: from 6 to 20 cm. Made to order.  
 \*Regalmodul nach Maß, cm-genaue Fertigung.  
 Breite: von 6 bis 20 cm. Auf Bestellung gefertigt.  
 \*Modulo scaffale su misura, realizzato cm per cm.  
 Larghezza: da 6 a 20 cm. Su ordinazione.

TALL  
HOCH  
ALTO

Finishes	Right
● Matte White	112 35 336 (XX)
● Natural Oak	112 24 336 (XX)
● Grey Pine	112 37 336 (XX)
● Walnut Vera	112 84 336 (XX)
○ Matte Anthracite	112 45 336 (XX)

Finishes	Left
● Matte White	112 35 337 (XX)
● Natural Oak	112 24 337 (XX)
● Grey Pine	112 37 337 (XX)
● Walnut Vera	112 84 337 (XX)
○ Matte Anthracite	112 45 337 (XX)

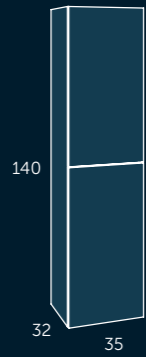

Replace XX with the reference of the selected handle model and finish:  
Ersetzen Sie XX durch die Referenz des gewählten Griffmodells und der Oberfläche:  
Sostituire XX con il riferimento del modello e della finitura della maniglia scelta:

Handle <b>LINE</b>	● Chrome (LC)	○ White (LB)	Handle <b>BEND</b>	● Chrome (BC)	○ Black (BN)
	○ Black (LN)	● Gold (LG)			

MEDIUM  
MITTEL  
MEDIO

Finishes	Reference
● Matte White	112 35 435
● Natural Oak	112 24 435
● Grey Pine	112 37 435
● Walnut Vera	112 84 435
○ Matte Anthracite	112 45 435



COUNTERTOP  
ABDECKUNG  
PIANO

DOES NOT INCLUDE REINFORCEMENT BAR / KEINE VERSTÄRKUNGSSTANGE ENTHALTEN / NON INCLUDE BARRA DI RINFORZO

60 (23.6")

Finishes	Reference
● Matte White	112 35 206
● Natural Oak	112 24 206
● Grey Pine	112 37 206
● Walnut Vera	112 84 206
○ Matte Anthracite	112 45 206

100 (39.4")

Finishes	Reference
● Matte White	112 35 210
● Natural Oak	112 24 210
● Grey Pine	112 37 210
● Walnut Vera	112 84 210
○ Matte Anthracite	112 45 210

140 (55.1")

Finishes	Reference
● Matte White	112 35 214
● Natural Oak	112 24 214
● Grey Pine	112 37 214
● Walnut Vera	112 84 214
○ Matte Anthracite	112 45 214

180 (71")

Finishes	Reference
● Matte White	112 35 218
● Natural Oak	112 24 218
● Grey Pine	112 37 218
● Walnut Vera	112 84 218
○ Matte Anthracite	112 45 218

70 (27.6")

Finishes	Reference
● Matte White	112 35 207
● Natural Oak	112 24 207
● Grey Pine	112 37 207
● Walnut Vera	112 84 207
○ Matte Anthracite	112 45 207

110 (43.3")

Finishes	Reference
● Matte White	112 35 211
● Natural Oak	112 24 211
● Grey Pine	112 37 211
● Walnut Vera	112 84 211
○ Matte Anthracite	112 45 211

150 (59")

Finishes	Reference
● Matte White	112 35 215
● Natural Oak	112 24 215
● Grey Pine	112 37 215
● Walnut Vera	112 84 215
○ Matte Anthracite	112 45 215

200 (78.7")

Finishes	Reference
● Matte White	112 35 220
● Natural Oak	112 24 220
● Grey Pine	112 37 220
● Walnut Vera	112 84 220
○ Matte Anthracite	112 45 220



SHELF X3 VERTICAL  
REGAL X3 VERTIKAL  
SCAFFALE X3 VERTICALE

Finishes	Reference
● Matte White	112 35 500
● Natural Oak	112 24 500
● Grey Pine	112 37 500
● Walnut Vera	112 84 500
○ Matte Anthracite	112 45 500
● Matte Mink	112 74 500
● Matte Leaf	112 47 500
● Matte Sunset	112 48 500
● Matte Island	112 49 500



VERTICAL SHELF  
REGAL VERTIKAL  
SCAFFALE VERTICALE

Finishes	Reference
● Matte White	112 35 510
● Natural Oak	112 24 510
● Grey Pine	112 37 510
● Walnut Vera	112 84 510
○ Matte Anthracite	112 45 510
● Matte Mink	112 74 510
● Matte Leaf	112 47 510
● Matte Sunset	112 48 510
● Matte Island	112 49 510



SHELF "L"  
REGAL "L"  
SCAFFALE "L"

Finishes	Reference
● Matte White	112 35 520
● Natural Oak	112 24 520
● Grey Pine	112 37 520
● Walnut Vera	112 84 520
○ Matte Anthracite	112 45 520
● Matte Mink	112 74 520
● Matte Leaf	112 47 520
● Matte Sunset	112 48 520
● Matte Island	112 49 520

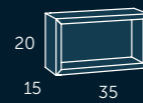

HORIZONTAL SHELF  
HORIZONTALTES REGAL  
SCAFFALE ORIZZONTALE

Finishes	Reference
● Matte White	112 35 505
● Natural Oak	112 24 505
● Grey Pine	112 37 505
● Walnut Vera	112 84 505
○ Matte Anthracite	112 45 505
● Matte Mink	112 74 505
● Matte Leaf	112 47 505
● Matte Sunset	112 48 505
● Matte Island	112 49 505

MYTHO  
COUNTERTOP  
ABDECKUNG / PIANO

CARRARA	
cm	Reference
61	532 76 060
81	532 76 080
101	532 76 100
121	532 76 120
141	532 76 140
cm linear	532 76 999

MARQUINA STORM	
cm	Reference
61	532 77 060
81	532 77 080
101	532 77 100
121	532 77 120
141	532 77 140
cm linear	532 77 999



PURE CEMENT	
cm	Reference
61	532 95 060
81	532 95 080
101	532 95 100
121	532 95 120
141	532 95 140
cm linear	532 95 999

Custom-made manufacturing on request up to 200 cm. Maßanfertigung auf Bestellung bis zu 200 cm. Produzione su misura su richiesta fino a 200 cm.

⚠ To avoid deformations in the countertops, the installation of the reinforcement bar in the module where the washbasin will be placed is necessary. Um Verformungen der Abdeckungen zu vermeiden, ist die Installation der Verstärkungsstange im Modul, auf dem das Waschbecken platziert wird, erforderlich. Per evitare deformazioni nei piani, è necessaria l'installazione della barra di rinforzo nel modulo dove verrà posizionato il lavabo.

FLOW f46  
PLINTHED COUNTERTOP  
WASCHBECKEN / TOP CON GONNA



60 (23.6")

Finishes	Reference
● Natural Oak	138 24 060
● Matte Mink	138 74 060

80 (31.5")

Finishes	Reference
● Natural Oak	138 24 080
● Matte Mink	138 74 080

120 (47.2")

Finishes	Reference
● Natural Oak	138 24 120
● Matte Mink	138 74 120

70 (27.6")

Finishes	Reference
● Natural Oak	138 24 070
● Matte Mink	138 74 070

100 (39.4")

Finishes	Reference
● Natural Oak	138 24 100
● Matte Mink	138 74 100

140 (55.1")

Finishes	Reference
● Natural Oak	138 24 140
● Matte Mink	138 74 140

REINFORCEMENT BAR  
WASCHTISCHPLATTEN-STABILISIERUNG  
BARRA DI RINFORZO

cm	Reference
60	425 14 060
70	425 14 070
80	425 14 080
100	425 14 100
120	425 14 120

To prevent deformations in the countertops, the installation of the reinforcement bar is necessary in the modules where the washbasin will be placed. Um Verformungen der Abdeckplatten zu vermeiden, ist die Installation der Waschtischplatten-Stabilisierung in den Modulen erforderlich, in denen das Waschbecken platziert wird. Per evitare deformazioni nei piani, è necessaria l'installazione della barra di rinforzo nei moduli in cui verrà posizionato il lavabo.

SPECIAL DRAWER  
SPEZIALSCHUBLADE  
CASSETTO SPECIALE

Check all the information on page 429. Konsultieren Sie alle Informationen auf Seite 429. Consulta tutte le informazioni nella pagina 429.

 OFFSET SIPHON CUTOUT  
/ VERSCHIEBBARER SIPHON / SIFONE REGOLABILE  
Ref: 432 00 001

A plan is required. Not available for all 1-drawer modules and 2-drawer modules of 60 and 120 2s cm. Ein Plan ist erforderlich. Nicht verfügbar für alle 1-Schubladen-Module und 2-Schubladen-Module in 60 und 120 2s cm. È necessario un piano. Non disponibile per tutti i moduli a 1 cassetto e per i moduli a 2 cassette da 60 e 120 2v cm.

 WITHOUT SIPHON CUTOUT  
/ OHNE SIPHON / SENZA SIFONE

Ref: 432 00 000  
Not available for the 120 cm size. Nicht verfügbar für die Größe 120 cm. Non disponibile per la misura di 120 cm.

SPOK  
METAL STRUCTURE WITH SHELF  
METALLSTRUKTUR MIT REGAL  
STRUTTURA METALLICA CON SCAFFALE

60 (23.6")

Shelf	Reference
● Matte White	165 35 060
● Natural Oak	165 24 060
● Grey Pine	165 37 060
● Walnut Vera	165 84 060
○ Matte Anthracite	165 45 060

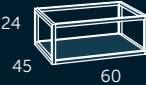

70 (27.6")

Shelf	Reference
● Matte White	165 35 070
● Natural Oak	165 24 070
● Grey Pine	165 37 070
● Walnut Vera	165 84 070
○ Matte Anthracite	165 45 070

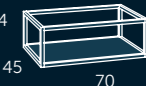

80 (31.5")

Shelf	Reference
● Matte White	165 35 080
● Natural Oak	165 24 080
● Grey Pine	165 37 080
● Walnut Vera	165 84 080
○ Matte Anthracite	165 45 080

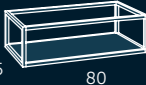

100 (39.4")

Shelf	Reference
● Matte White	165 35 100
● Natural Oak	165 24 100
● Grey Pine	165 37 100
● Walnut Vera	165 84 100
○ Matte Anthracite	165 45 100



MIRRORS  
SPIEGEL / SPECCHI



MIRRORS  
/ SPIEGEL / SPECCHI  
page 414

LED MIRRORS  
/ SPIEGEL / SPECCHI  
page 417

SIDE CABINETS  
/ HÄNGERSCHRÄNKE / ARMADI  
page 420

WASHBASINS  
WASCHBECKEN / LAVABOS



CERAMIC  
from 60 to 120 cm  
page 408

SOLID SURFACE  
from 60 to 200 cm  
page 327

RESIN COLOUR  
from 60 to 200 cm  
page 353



# SÁHARA

60 | 80 | 100 | 120





-  Metal interior drawers.  
Metallzierleiste.  
Sistema di estrazione metallico.
-  Total extraction.  
Vollauszug.  
Estrazione totale.
-  Organizer unit.  
Utensilien Behälter.  
Organizatore.
-  Soft close.  
Soft-close-System.  
Chiusura ammortizzata.
-  GRASS  
Grass sliding system.  
Körpuschiene Grass.  
Guide Grass.
-  Soft close.  
Soft-close-System.  
Chiusura ammortizzata.
-  Matte lacquered finish.  
Matt lackiert.  
Lacato opaco.
-  Anti fog system.  
Anti-Beschlag-System.  
Sistema antiappannamento.
-  Ambient light.  
Umgebungslicht.  
Luce ambiente.
-  Intensity control.  
Intensitätsregler.  
Regolatore di intensità.
-  Dual sensor On/Off-anti fog.  
Doppelter Sensorschalter, On/Off.  
Doppio sensore touch, On/Off.  
Antiappannante.



## SÁHARA 60

- 120 24 25 060 Sáhara 60 Natural Oak + Leaf
- 506 01 060 G Ambar
- without drilled tap hole / Ohne Armaturenloch / senza foro per rubinetto
- 246 00 060 Verona
- 120 24 25 335 Sáhara Tall Natural Oak + Leaf / Hoch / Alto
- 412 03 808 Combi Wall-Mounted Gold

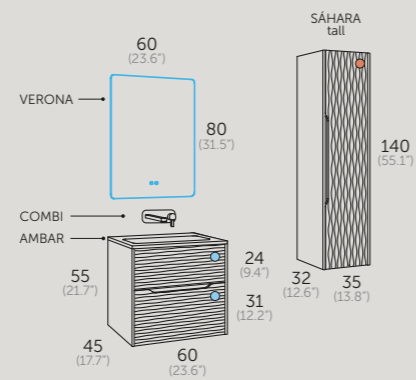

### SIDES

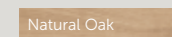

### SIDES AND FRONTS

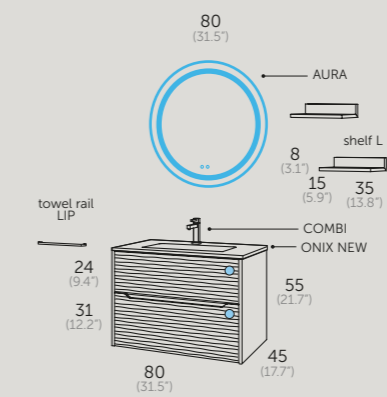
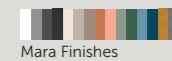

## SÁHARA 80

- 120 23 23 080 Sáhara 80 Island
- 550 01 080 Onix New
- 250 02 080 Aura
- 416 00 002 Towel Rail LIP 60 / Handtuchhalter / Porta asciugamani
- 112 49 520 Shelf L Island / Regal L / Scaffale L
- 412 00 801 Combi Black



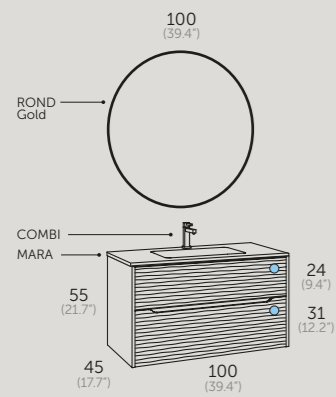

## SÁHARA 100

120 02 02 100 Sáhara 100 Black  
 540 02 100 Mara Black  
 244 72 100 Rond Gold  
 412 00 802 Combi Gold



SIDES

Natural Oak

SIDES AND FRONTS



Metal interior drawers.  
 Metallzierleiste.  
 Sistema di estrazione metallico.



Total extraction.  
 Vollauszug.  
 Estrazione totale.



Organizer unit.  
 Utensilien Behälter.  
 Organizzatore.



Soft close.  
 Soft-close-System.  
 Chiusura ammortizzata.



Grass sliding system.  
 Körperschiene Grass.  
 Guide Grass.



Matte lacquered finish.  
 Matt lackiert.  
 Laccato opaco.



-  Metal interior drawers. Metallzierleiste. Sistema di estrazione metallico.
-  Total extraction. Vollauszug. Estrazione totale.
-  Organizer unit. Utensilien Behälter. Organizzatore.
-  Soft close. Soft-close-System. Chiusura ammortizzata.
-  GRASS Grass sliding system. Korpussschiene Grass. Guide Grass.
-  Soft close. Soft-close-System. Chiusura ammortizzata.
-  Matte lacquered finish. Matt lackiert. Laccato opaco.
-  Anti fog system. Anti-Beschlag-System. Sistema antiappannamento.
-  Ambient light. Umgebungslicht. Luce ambiente.
-  Intensity control. Intensitätsregler. Regolatore di intensità.
-  Dual sensor On/Off-anti fog. Doppelter Sensorschalter. On/Off. Doppio sensore di con tatto. On/Off. Antiappannante.

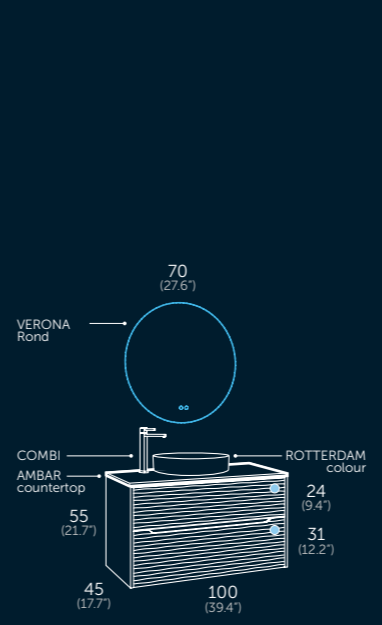

### SÁHARA 100

- 120 08 08 100 Sáhara 100 Sunset
- 508 01 100 Ambar Countertop / Abdeckung / Piano
- 425 14 100 Reinforcement Bar / Waschtischplatten-Stabilisierung / Barra di rinforzo
- 535 06 004 Rotterdam Colour White
- 247 00 070 Verona Rond
- 412 00 806 Combi Tall Black / Hoch / Alto

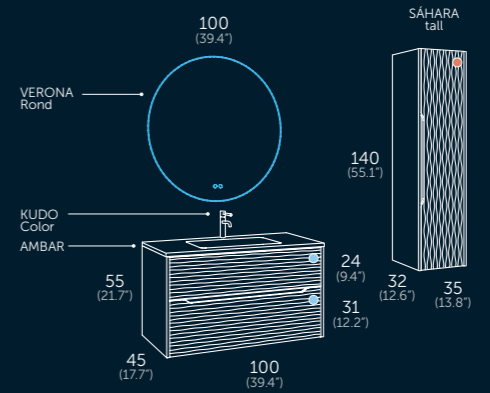





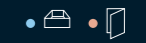

### SÁHARA 100

- 120 22 22 100 Sáhara 100 Mist
- 506 01 100 Ambar
- 247 00 100 Verona Rond
- 120 22 22 335 Sáhara Tall Mist / Hoch / Alto
- 412 06 811 Kudo Full Color White





-  Metal interior drawers. Metallzierleiste. Sistema di estrazione metallico.
-  Total extraction. Vollauszug. Estrazione totale.
-  Organizer unit. Utensilien Behälter. Organizzatore.
-  Soft close. Soft-close-System. Chiusura ammortizzata.
-  GRASS Grass sliding system. Korpussschiene Grass. Guide Grass.
-  Soft close. Soft-close-System. Chiusura ammortizzata.
-  Matte lacquered finish. Matt lackiert. Laccato opaco.

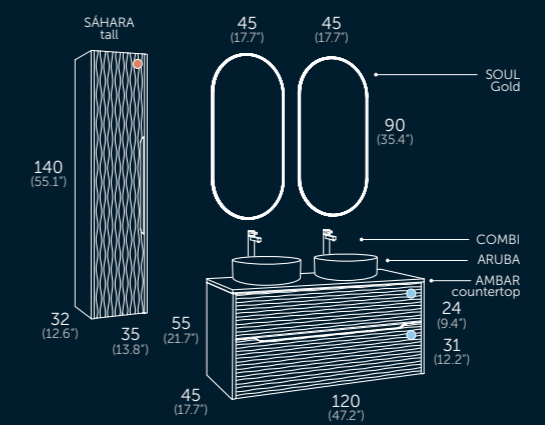

**SÁHARA tall**  
140 (55.1)  
32 (12.6) 35 (13.8) 55 (21.7)

**SOUL Gold**  
45 (17.7) 45 (17.7) 90 (35.4)

**COMBI ARUBA AMBAR countertop**  
24 (9.4) 31 (12.2)

45 (17.7) 120 (47.2)

**SÁHARA 120 2 SINKS**

120 10 10 122	Sáhara 120 2s Blue Space
508 01 120	Ambar Countertop / Waschtischplatte / Piano
425 14 120	Reinforcement Bar / Waschtischplatten-Stabilisierung / Barra di rinforzo
581 10 037	Aruba Blue Space
239 72 090	Soul Gold
120 10 10 335	Sáhara Tall Blue Space / Hoch / Alto
412 00 807	Combi Tall Gold / Hoch / Alto



**SIDES**

Natural Oak

**SIDES AND FRONTS**

Mara Finishes



-  Metal interior drawers. Metallizerleiste. Sistema di estrazione metallico.
-  Total extraction. Vollauszug. Estrazione totale.
-  Organizer unit. Utensilien Behälter. Organizzatore.
-  Soft close. Soft-close-System. Chiusura ammortizzata.
-  Grass sliding system. Korpuschiene Grass. Guide Grass.
-  Soft close. Soft-close-System. Chiusura ammortizzata.
-  Matte lacquered finish. Matt lackiert. Laccato opaco.
-  Anti fog system. Anti-Beschlag-System. Sistema antiappannamento.
-  Ambient light. Umgebungslicht. Luce ambiente.
-  Dual sensor On/Off-anti fog. Doppelter Sensorschalter. On/Off. Doppio sensore di con tatto. On/Off. Antiappannante.
-  Digital clock. Digitaluhr. Orologio digitale.
-  Bluetooth music player. 2 speakers of 3W each. Musik Player integriert. Bluetooth Anschluss. 2 Lautsprecher je mit 3W. Lettore musicale integrato, connessione a Bluetooth. 2 altoparlanti 3W ciascuno.

## SÁHARA 120 2 SINKS

- 120 24 06 122 Sáhara 120 2s Natural Oak + White
- 432 00 001 Special Drawer 1 offset sink / Spezialschublade 1 versetztes Becken / Cassetto speciale 1 vasque decentrato
- 112 24 212 Landes Countertop / Abdeckung / Piano
- 425 14 120 Reinforcement Bar / Waschtischplatten-Stabilisierung / Barra di rinforzo
- 530 01 035 Tre 50
- 267 00 120 Spoty
- 120 24 06 335 Sáhara Tall Natural Oak + White / Hoch / Alto
- 412 00 805 Combi Tall Chrome / Hoch / Alto

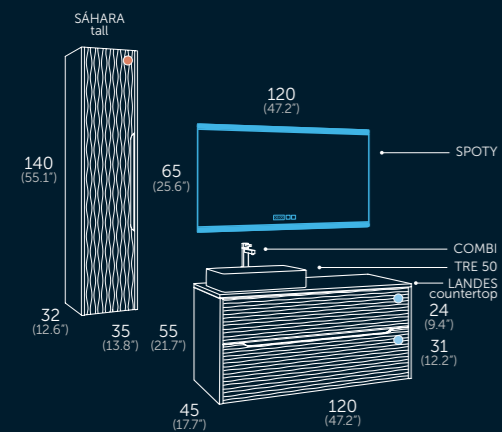
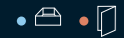

SIDES

Natural Oak

SIDES AND FRONTS

Mara Finishes



S: Sides | F: Fronts

### SÁHARA 60 (23.62")

Finishes **S F**

- Natural Oak 120 24 XX 060
- Mara Finishes 120 XX XX 060

Replace the X with the colour reference.  
Ersetzen Sie das X durch die Farbbref.  
Sostituire la X con il riferimento del colore.

### SÁHARA 80 (31.49")

Finishes **S F**

- Natural Oak 120 24 XX 080
- Mara Finishes 120 XX XX 080

Replace the X with the colour reference.  
Ersetzen Sie das X durch die Farbbref.  
Sostituire la X con il riferimento del colore.

### SÁHARA 100 (39.37")

Finishes **S F**

- Natural Oak 120 24 XX 100
- Mara Finishes 120 XX XX 100

Replace the X with the colour reference.  
Ersetzen Sie das X durch die Farbbref.  
Sostituire la X con il riferimento del colore.

### SÁHARA 120 (47.24")

2 SINKS / 2 SPÜLBECKEN / 2 LAVELLI

Finishes **S F**

- Natural Oak 120 24 XX 122
- Mara Finishes 120 XX XX 122

Replace the X with the colour reference.  
Ersetzen Sie das X durch die Farbbref.  
Sostituire la X con il riferimento del colore.

**FINISHES IN STOCK**  
Sides: Natural Oak and Black.  
Fronts: White, Mist, Black, Mink, Leaf and Blue Space.

LAMINATED / LAMINAT / LAMINATO (sides only)

Natural Oak 24	
White 06	Flower 26
Mist 22	Leaf 25
Anthracite 03	Garden 73
Black 02	Island 23
Beige 05	Blue Space 10
Mink 19	Metallic Gold 16
Soil 20	Metallic Lead 17
Sunset 08	

46 46 46 46

61 61 61 61

<b>ONIX NEW</b> ceramic Reference ● Glossy White 550 01 060 ● Matte Colour 552 XX 060	<b>AMBAR / MARA</b> Reference ● Solid Surface 506 01 060 ● Resin Colour 540 XX 060	<b>ZEN / IRIS</b> Reference ● Solid Surface 555 01 060 ● Resin Colour 536 XX 060	<b>AMBAR / MARA</b> countertop Reference ● Solid Surface 508 01 060 ● Resin Colour 542 XX 060
--	---	---	--

46 46 46 46

81 81 81 81

<b>ONIX NEW</b> ceramic Reference ● Glossy White 550 01 080 ● Matte Colour 552 XX 080	<b>AMBAR / MARA</b> Reference ● Solid Surface 506 01 080 ● Resin Colour 540 XX 080	<b>ZEN / IRIS</b> Reference ● Solid Surface 555 01 080 ● Resin Colour 536 XX 080	<b>AMBAR / MARA</b> countertop Reference ● Solid Surface 508 01 080 ● Resin Colour 542 XX 080
--	---	---	--

46 46 46 46

101 101 101 101

<b>ONIX NEW</b> ceramic Reference ● Glossy White 550 01 100	<b>AMBAR / MARA</b> Reference ● Solid Surface 506 01 100 ● Resin Colour 540 XX 100	<b>ZEN / IRIS</b> Reference ● Solid Surface 555 01 100 ● Resin Colour 536 XX 100	<b>AMBAR / MARA</b> countertop Reference ● Solid Surface 508 01 100 ● Resin Colour 542 XX 100
---	---	---	--

46 46 46 46 46

121 121 121 121 121

30 | Left (60+60)

<b>ONIX NEW</b> ceramic Reference ● Glossy White 550 01 122	<b>AMBAR / MARA</b> Reference ● Solid Surface 506 01 122 ● Resin Colour 540 XX 122	<b>ZEN / IRIS</b> Reference ● Solid Surface 555 01 122 ● Resin Colour 536 XX 122	<b>ONIX NEW</b> ceramic Reference ● Glossy White 550 01 121	<b>AMBAR / MARA</b> countertop Reference ● Solid Surface 508 01 120 ● Resin Colour 542 XX 120
---	---	---	---	--

countertop basin / Aufsatzwaschbecken / lavabi da appoggio

46 35 33 34

13.5 33 12 51 11 51 11 37 11 51

<b>DUE</b> ceramic Reference ● Glossy White 530 01 002	<b>TRE 50</b> ceramic Reference ● Glossy White 530 01 035 ● Matte Colour 535 XX 035	<b>MILOS/MASAI</b> Reference ● Solid Surface 509 01 052 ● Resin Colour 518 XX 051	<b>ATENAS/ARUBA</b> Reference ● Solid Surface 580 01 037 ● Resin Colour 581 XX 037	<b>CURAZAO</b> resin deco Reference ● Carrara 585 76 034 ● Marquina Storm 585 77 034 ● Pure Cement 585 95 034
--	--	--	---	---

**LANDES COUNTERTOP**

Reinforcement Bar not included.  
Verstärkungsstange nicht enthalten.  
Barra di rinforzo non inclusa.

46 1.9

cm	Natural Oak
60	112 24 206
80	112 24 208
100	112 24 210
120	112 24 212

**REINFORCEMENT BAR ALUMINIUM**

It is necessary to install it to avoid deformation of the countertop.  
Es ist erforderlich, es zu installieren, um eine Verformung der Arbeitsplatte zu vermeiden.  
È necessario installarlo per evitare deformazioni del piano.

cm Reference

60	425 14 060
80	425 14 080
100	425 14 100
120	425 14 120

**DRILLING SERVICE**  
Plan required. Ref: 435 00 050

Replace the **XX** by the chosen colour code.  
Ersetzen Sie **XX** durch den Code der ausgewählten Farbe.  
Sostituire l'**XX** con il codice colore scelto.

60 55 60 60 60 60 50 60

80 80 80 80 80 80 80 80 80

<b>SUN</b> Reference 204 00 060	<b>SOUL</b> Reference 239 00 080	<b>ROND</b> Reference ● BLACK 244 02 060 ● GOLD 244 72 060	<b>VERONA LED</b> Reference 246 00 060	<b>RAIN LED</b> Reference 269 00 060	<b>AURA STRAP LED</b> Reference 251 02 060	<b>JAZZ LED</b> Reference 271 02 050	<b>ORION / OSIRIS LED</b> Reference ● Solid Surface 210 01 060 ● Resin Colour 211 XX 060
---------------------------------------	--	---	--	--	--	--	---

80 80 80 80 80 80 80 80 80

80 80 80 80 80 80 80 80 80

<b>SUN</b> Reference 204 00 080	<b>ROND</b> Reference 244 00 080	<b>ROND</b> Reference ● BLACK 244 02 080 ● GOLD 244 72 080	<b>VERONA LED</b> Reference 246 00 080	<b>VERONA ROND LED</b> Reference 247 00 080	<b>AURA LED</b> Reference 250 02 080	<b>SPOTY LED</b> Reference 267 00 080	<b>ORION / OSIRIS LED</b> Reference ● Solid Surface 210 01 080 ● Resin Colour 211 XX 080
---------------------------------------	--	---	--	---	--	---	---

100 100 100 100 100 100 100 100 100

80 80 80 80 80 80 80 80 80

<b>SUN</b> Reference 204 00 100	<b>ROND</b> Reference 244 00 100	<b>ROND</b> Reference ● BLACK 244 02 100 ● GOLD 244 72 100	<b>VERONA LED</b> Reference 246 00 100	<b>VERONA ROND LED</b> Reference 247 00 100	<b>AURA LED</b> Reference 250 02 100	<b>SPOTY LED</b> Reference 267 00 100	<b>ORION / OSIRIS LED</b> Reference ● Solid Surface 210 01 100 ● Resin Colour 211 XX 100
---------------------------------------	--	---	--	---	--	---	---

120 45 45 45 45 120

80 90 90 90 80

<b>SUN</b> Reference 204 00 120	<b>SOUL</b> Reference 239 00 090	<b>SOUL</b> Reference ● BLACK 239 02 090 ● GOLD 239 72 090	<b>VERONA LED</b> Reference 246 00 120
---------------------------------------	--	---	--

accessories / Zubehör / complementi

120 45 45 45 45 120

<b>KUDO</b> tap Reference ● Brushed Steel 412 04 810 ● Black 412 02 810 ● Brushed Gold 412 03 810 ● Full Color 412 XX 811	<b>COMBI TALL</b> tap Reference ● Chrome 412 00 805 ● Black 412 00 806 ● Gold 412 00 807 ● Full Color 412 XX 804	<b>WALL-MOUNTED</b> tap Reference ● Chrome 412 00 808 ● Black 412 02 808 ● Gold 412 03 808	<b>LUX 38</b> towel rail Reference ● Chrome 417 00 038 ● Black 417 02 038 ● White 417 27 038
<b>ESTHER 30</b> Reference 400 00 141	<b>ESTHER BLACK 45</b> Reference 400 02 191	<b>SOFIA 60</b> Reference 400 00 141	<b>SIPHON</b> cutout lid Reference 418 00 000

**SPECIAL DRAWER**  
SPEZIALSCHUBLADE / CASSETTO SPECIALE

Check all the information on page 429.  
Konsultieren Sie alle Informationen auf Seite 429.  
Consulta tutte le informazioni nella pagina 429.

**OFFSET SIPHON CUTOUT**  
VERSCHIEBBARER SIPHON / SIFONE REGOLABILE  
Ref: 432 00 001

Not available for the 60 cm and 120 cm (2 sinks) sizes.  
Option: 1 centred or offset sink for the 120 cm size.  
Nicht verfügbar für die Größen 60 cm und 120 cm (2 Becken).  
Option: 1 zentriertes oder versetztes Becken für die Größe 120 cm.  
Non disponibile per le misure 60 cm e 120 cm (2 lavabi). Opzione: 1 lavabo centrato o decentrato per la misura 120 cm.

**WITHOUT SIPHON CUTOUT**  
OHNE SIPHON / SENZA SIFONE  
Ref: 432 00 000

side cabinet / Hängeschränke / armadi

S: Sides | F: Fronts

**SÁHARA TALL**

Finishes **S F**

- Natural Oak 120 24 XX 335
- Mara Finishes 120 XX XX 335

Replace the X with the colour reference.  
Ersetzen Sie das X durch die Farbbref.  
Sostituire la X con il riferimento del colore.  
Reversible opening | Reversible Öffnung  
| Apertura reversibile

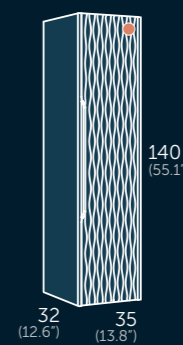



# LAMBDA

80 | 100 | 120







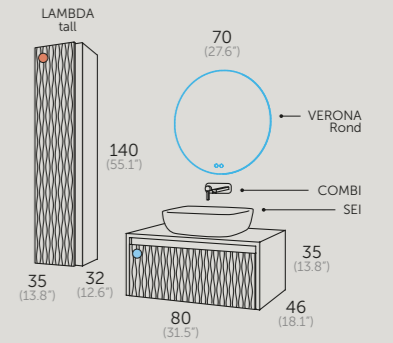







FRONT TEXTURE	FRONT FINISH
Smooth	Natural Oak
Smooth	
Dune	Mara Finishes



### LAMBDA 80

- 164 06 081 Lambda Dune 80 White
- 530 01 006 Sei
- 247 00 070 Verona Rond
- 164 06 336 Lambda Tall Dune White / Hoch / Alto
- 412 00 808 Combi Wall-Mounted Chrome





-  Metal interior drawers.  
Metallzierleiste.  
Sistema di estrazione metallico.
-  Total extraction.  
Vollauszug.  
Estrazione totale.
-  Soft close.  
Soft-close-System.  
Chiusura ammortizzata.
-  GRASS  
Grass sliding system.  
Korpusschiene Grass.  
Guide Grass.
-  Soft close.  
Soft-close-System.  
Chiusura ammortizzata.
-  Matte lacquered finish.  
Matt lackiert.  
Laccato opaco.
-  Anti fog system.  
Anti-Beschlag-System.  
Sistema antiappannamento.
-  Ambient light.  
Umgebungslicht.  
Luce ambiente.
-  Intensity control.  
Intensitätsregler.  
Regolatore di intensità.
-  Dual sensor On/Off-anti fog.  
Doppelter Sensorschalter. On/Off.  
Doppio sensore touch. On/Off.  
Antiappannante.



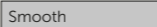
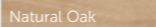
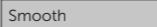

-  Metal interior drawers.  
Metallzierleiste.  
Sistema di estrazione metallico.
-  Total extraction.  
Vollauszug.  
Estrazione totale.
-  Soft close.  
Soft-close-System.  
Chiusura ammortizzata.
-  GRASS  
Grass sliding system.  
Korpusschiene Grass.  
Guide Grass.
-  Soft close.  
Soft-close-System.  
Chiusura ammortizzata.
-  Matte lacquered finish.  
Matt lackiert.  
Laccato opaco.
-  Anti fog system.  
Anti-Beschlag-System.  
Sistema antiappannamento.
-  Ambient light.  
Umgebungslicht.  
Luce ambiente.
-  Digital clock.  
Digitaluhr.  
Orologio digitale.
-  Dual sensor On/Off-anti fog.  
Doppelter Sensorschalter. On/Off.  
Doppio sensore touch. On/Off.  
Antiappannante.
-  Bluetooth music player.  
2 speakers of 3W each.  
Musik Player integriert, Bluetooth  
Anschluss. 2 Lautsprecher je mit 3W.  
Lettore musicale integrato, connessione  
a Bluetooth. 2 altoparlanti 3W ciascuno.

FRONT TEXTURE	FRONT FINISH
 Smooth	 Natural Oak
 Smooth	 Mara Finishes
 Dune	

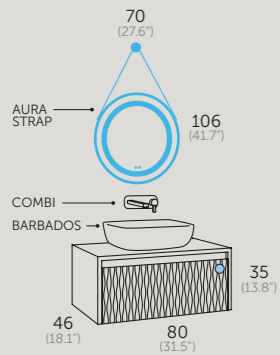

### LAMBDA 80

- 164 19 081 Lambda Dune 80 Mink
- 583 77 037 Barbados Marquina Storm
- 251 02 070 Aura Strap
- 412 02 808 Combi Wall-Mounted Black

### LAMBDA 100

- 164 25 101 Lambda Dune 100 Leaf
- 518 47 051 Masai Leaf
- 267 00 100 Spoty
- 164 25 336 Lambda Tall Dune Leaf / Hoch / Alto
- 412 02 815 Kudo Tall Black / Hoch / Alto

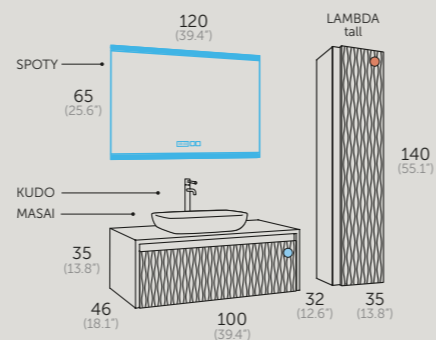

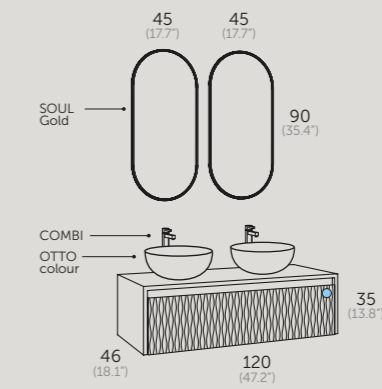

### LAMBDA 120

- 164 73 121 Lambda Dune 120 Garden
- 535 73 008 Otto Colour Garden
- 239 72 090 Soul Gold
- 412 00 807 Combi Tall Gold / Hoch / Alto



-  Metal interior drawers.  
Metallzierleiste.  
Sistema di estrazione metallico.
-  Total extraction.  
Vollauszug.  
Estrazione totale.
-  Soft close.  
Soft-close-System.  
Chiusura ammortizzata.
-  Grass sliding system.  
Körpuschiene Grass.  
Guide Grass.
-  Matte lacquered finish.  
Matt lackiert.  
Laccato opaco.

FRONT TEXTURE	FRONT FINISH
Smooth	Natural Oak
Smooth	Mara Finishes
Dune	

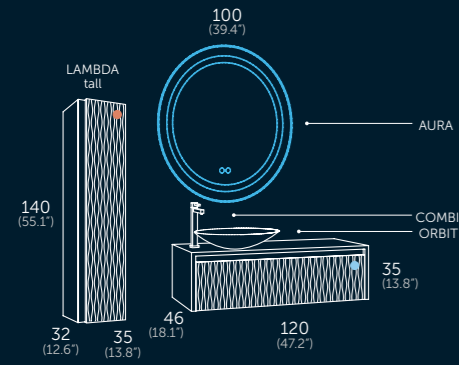

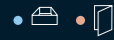

## LAMBDA 120

- 164 02 121 Lambda Dune 120 Black
- 518 02 057 Orbit Black
- 250 02 100 Aura
- 164 02 336 Lambda Tall Dune Black / Hoch / Alto
- 412 00 806 Combi Tall Black / Hoch / Alto





 Metal interior drawers. Metallzierleiste.  
Sistema di estrazione metallico.

 Total extraction. Vollauszug.  
Estrazione totale.

 Soft close. Soft-close-System.  
Chiusura ammortizzata.



 GRASS Grass sliding system. Korpuschiene  
Grass. Guide Grass.

 Soft close. Soft-close-System.  
Chiusura ammortizzata.

 Matte lacquered finish. Matt lackiert.  
Laccato opaco.

 Anti fog system. Anti-Beschlag-System.  
Sistema antiappannamento.

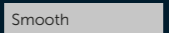
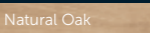
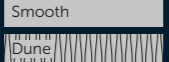
 Dual sensor On/Off-anti fog. Doppelter  
Sensorschalter. On/Off. Doppio sensore  
di con tatto. On/Off. Antiappannante.

FRONT TEXTURE	FRONT FINISH
 Smooth	 Natural Oak
 Dune	 Mara Finishes



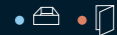

## LAMBDA 80 (31.49")

**SMOOTH / GLATT / LISCIO**  
Front Finish Reference

- Natural Oak 164 24 080
- Mara Finishes 164 XX 080

**DUNE TEXTURE / TEXTUR / TEXTURE**  
Front Finish Reference

- Mara Finishes 164 XX 081

Replace XX with the colour reference.  
Ersetzen Sie XX durch die Farbreferenz.  
Sostituire XX con il riferimento colore.

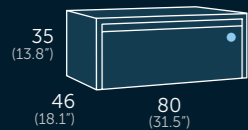

## LAMBDA 100 (39.37")

**SMOOTH / GLATT / LISCIO**  
Front Finish Reference

- Natural Oak 164 24 100
- Mara Finishes 164 XX 100

**DUNE TEXTURE / TEXTUR / TEXTURE**  
Front Finish Reference

- Mara Finishes 164 XX 101

Replace XX with the colour reference.  
Ersetzen Sie XX durch die Farbreferenz.  
Sostituire XX con il riferimento colore.

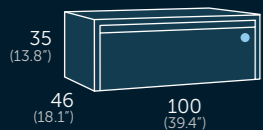

## LAMBDA 120 (47.24")

**SMOOTH / GLATT / LISCIO**  
Front Finish Reference

- Natural Oak 164 24 120
- Mara Finishes 164 XX 120

**DUNE TEXTURE / TEXTUR / TEXTURE**  
Front Finish Reference

- Mara Finishes 164 XX 121

Replace XX with the colour reference.  
Ersetzen Sie XX durch die Farbreferenz.  
Sostituire XX con il riferimento colore.

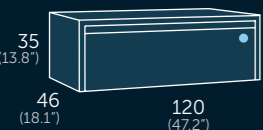

**FINISHES IN STOCK**  
AUF LAGER VERFÜGBARE OBERFLÄCHEN  
FINITURE DISPONIBILI IN MAGAZZIN



Fronts: White and Black  
Fronten: Weiß und Schwarz / Frontali: Bianco e Nero

LAMINATED / LAMINAT / LAMINATO (smooth)

Natural Oak 24

MATTE LACQUER / MATTLACK / LACCATO OPACO  
(smooth or dune texture) Only fronts.

White 06	Flower 26
Mist 22	Leaf 25
Anthracite 03	Garden 73
Black 02	Island 23
Beige 05	Blue Space 10
Mink 19	Metallic Gold 16
Soil 20	Metallic Lead 17
Sunset 08	

## ORGANIZER

ORGANISATOR / ORGANIZZATORE  
Reference 411 00 001

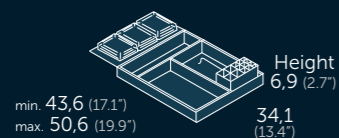

## countertop basins / Aufsatzwaschbecken / lavabi da appoggio

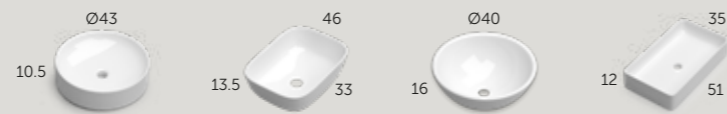

<b>ROTTERDAM</b> ceramic Reference ● Glossy White 507 01 004 ● Matte Colour 535 XX 004	<b>DUE</b> ceramic Reference ● Glossy White 530 01 002	<b>OTTO</b> ceramic Reference ● Glossy White 530 01 008 ● Matte Colour 535 XX 008	<b>TRE 50</b> ceramic Reference ● Glossy White 530 01 035 ● Matte Colour 535 XX 035
---	--	--	--



<b>OVAL/ORBIT</b> Reference ● Solid Surface 509 01 001 ● Resin Colour 518 XX 057	<b>MILOS/MASAI</b> Reference ● Solid Surface 509 01 052 ● Resin Colour 518 XX 051	<b>ATENAS/ARUBA</b> Reference ● Solid Surface 580 01 037 ● Resin Colour 581 XX 037	<b>ZANTE / SAONA</b> Reference ● Solid Surface 559 01 050 ● Resin Colour 586 XX 049
---	--	---	--



<b>ARUBA</b> resin deco Reference ● Carrara 581 76 037 ● Marquina Storm 581 77 037 ● Pure Cement 581 95 037	<b>CURAZAO</b> resin deco Reference ● Carrara 585 76 034 ● Marquina Storm 585 77 034 ● Pure Cement 585 95 034	<b>BARBADOS</b> resin deco Reference ● Carrara 583 76 037 ● Marquina Storm 583 77 037 ● Pure Cement 583 95 037
---	---	--

## DRILLING SERVICE LAMBDA

Plan required. Ref: 435 00 164

## taps / Armaturen / rubinetteria



<b>COMBI TALL tap</b> Reference ● Chrome 412 00 805 ● Black 412 00 806 ● Gold 412 00 807	<b>COMBI TALL tap</b> Reference ● Full Color 412 XX 804	<b>KUDO TALL tap</b> Reference ● Steel 412 04 815 ● Black 412 02 815 ● Brushed Gold 412 03 815	<b>KUDO TALL tap</b> Reference ● Colour 412 XX 816	<b>WALL-MOUNTED tap</b> Reference ● Chrome 412 00 808 ● Black 412 02 808 ● Gold 412 03 808
--	---	--	--	--

## accessories / Zubehör / complementi



<b>DRAIN clic clac</b> Reference ● Black 410 02 203 ● White 410 01 203 ● Brushed Gold 410 03 203	<b>DRAIN clic clac</b> Reference ● Chrome 409 00 203 ● Colour 409 XX 203	<b>ADHESIVE 3M towel rail</b> Reference ● Chrome 416 00 037 ● Black 416 02 037
--	---	---

Replace the XX by the chosen colour code.  
Ersetzen Sie XX durch den Code der ausgewählten Farbe.  
Sostituire l'XX con il codice colore scelto.

## mirrors / Spiegel / specchi

### 80 cm (31.49")

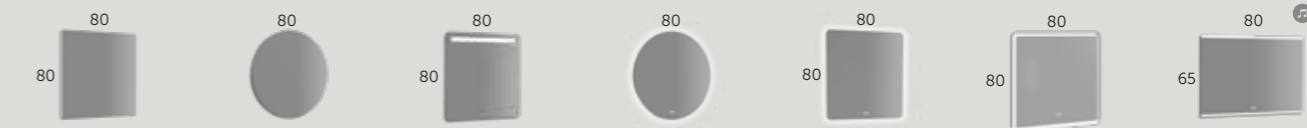

<b>SUN</b> Reference 204 00 080	<b>ROND</b> Reference 244 00 080	<b>RAIN LED</b> Reference 269 00 080	<b>VERONA ROND LED</b> Reference 247 00 080	<b>VERONA LED</b> Reference 246 00 080	<b>ORION / OSIRIS LED</b> Reference ● Solid Surface 210 01 080 ● Resin Colour 211 XX 080	<b>SPOTY LED</b> Reference 267 00 080
------------------------------------	-------------------------------------	---	--	---	---	--

### 100 cm (39.37")

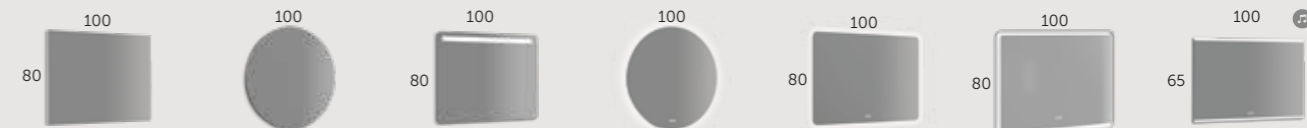

<b>SUN</b> Reference 204 00 100	<b>ROND</b> Reference 244 00 100	<b>RAIN LED</b> Reference 269 00 100	<b>VERONA ROND LED</b> Reference 247 00 100	<b>VERONA LED</b> Reference 246 00 100	<b>ORION / OSIRIS LED</b> Reference ● Solid Surface 210 01 100 ● Resin Colour 211 XX 100	<b>SPOTY LED</b> Reference 267 00 100
------------------------------------	-------------------------------------	---	--	---	---	--

### 120 cm (47.24")

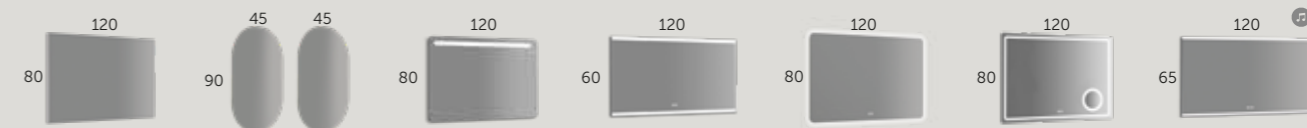

<b>SUN</b> Reference 204 00 120	<b>SOUL</b> Reference 239 00 090	<b>RAIN LED</b> Reference 269 00 120	<b>TOWER LED</b> Reference 262 00 120	<b>VERONA LED</b> Reference 246 00 120	<b>COSMOS LED</b> Reference 270 00 120	<b>SPOTY LED</b> Reference 267 00 120
------------------------------------	-------------------------------------	---	--	---	---	--

## mirrors / Spiegel / specchi

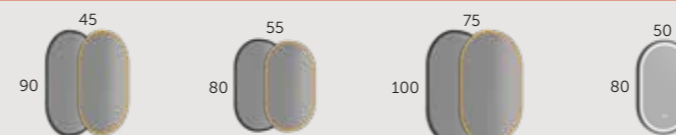

<b>SOUL</b> Reference ● BLACK 239 02 090 ● GOLD 239 72 090	<b>SOUL</b> Reference ● BLACK 239 02 080 ● GOLD 239 72 080	<b>SOUL</b> Reference ● BLACK 239 02 100 ● GOLD 239 72 100	<b>JAZZ LED</b> Reference 271 02 050
---	---	---	---

## spotlights / LED Beleuchtung / lampade da parete



<b>ESTHER BLACK 30</b> Reference 400 02 141	<b>ESTHER BLACK 45</b> Reference 400 02 191	<b>SOFIA 60</b> Reference 400 00 141	<b>AINHOA 74</b> Reference 400 00 152
--	--	---	--

## mirrored cabinets / Spiegelschränke / armadietti a specchio

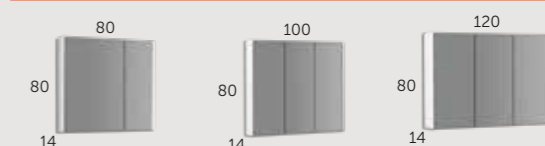

<b>SKYLINE 80 cabinet</b> Reference ● Natural Oak 341 24 080 2 Doors	<b>SKYLINE 100 cabinet</b> Reference ● Natural Oak 341 24 100 3 Doors	<b>SKYLINE 120 cabinet</b> Reference ● Natural Oak 341 24 120 3 Doors
---	--	--

## side cabinet / Hängeschränke / armadi

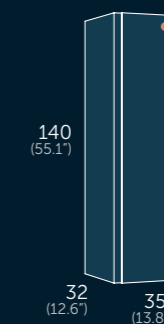

## LAMBDA TALL

**SMOOTH / GLATT / LISCIO**  
Front Finish Reference

- Natural Oak 164 24 335
- Mara Finishes 164 XX 335

**DUNE TEXTURE / TEXTUR / TEXTURE**  
Front Finish Reference

- Mara Finishes 164 XX 336

Replace XX with the colour reference.  
Ersetzen Sie XX durch die Farbreferenz.  
Sostituire XX con il riferimento colore.

Reversible opening | Umkehrbare Öffnung | Apertura reversibile











# CENIT

80 | 100 | 120





-  Metal interior drawers.  
Metallzierleiste.  
Sistema di estrazione metallico.
-  Total extraction.  
Vollauszug.  
Estrazione totale.
-  Organizer unit.  
Utensilien Behälter.  
Organizzatore.
-  Soft close.  
Soft-close-System.  
Chiusura ammortizzata.
-  GRASS  
Grass sliding system.  
Körpuschiene Grass.  
Guide Grass.
-  Soft close.  
Soft-close-System.  
Chiusura ammortizzata.
-  Matte lacquered finish.  
Matt lackiert.  
Laccato opaco.
-  Anti fog system.  
Anti-Beschlag-System.  
Sistema antiappannamento.
-  Dual sensor On/Off-anti fog.  
Doppelter Sensorschalter, On/Off.  
Doppio sensore touch, On/Off.  
Antiappannante.



### CENIT 100

- 163 21 100 Cenit 100
- 506 01 107 Ambar (70+30) Left / Links / Sinistra
- 204 00 100 Sun
- 412 00 800 Combi Chrome

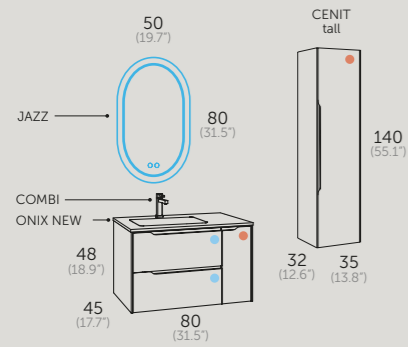
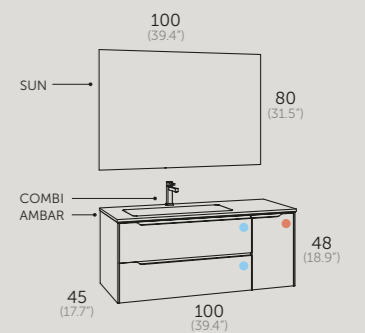







### CENIT 80

- 163 75 080 Cenit 80
- 506 01 081 Onix New (60+20) Left / Links / Sinistra
- 271 02 050 Jazz
- 163 75 340 Cenit Tall Mist / Hoch / Alto
- 412 00 801 Combi Black



- Matte White
- Matte Mink
- Matte Mist
- Matte Blue Space



-  Metal interior drawers.  
Metallzierleiste.  
Sistema di estrazione metallico.
-  Total extraction.  
Vollauszug.  
Estrazione totale.
-  Organizer unit.  
Utensilien Behälter.  
Organizzatore.
-  Soft close.  
Soft-close-System.  
Chiusura ammortizzata.
-  GRASS  
Grass sliding system.  
Körpuschiene Grass.  
Guide Grass.
-  SOFT  
Soft close.  
Soft-close-System.  
Chiusura ammortizzata.
-  Matte lacquered finish.  
Matt lackiert.  
Laccato opaco.

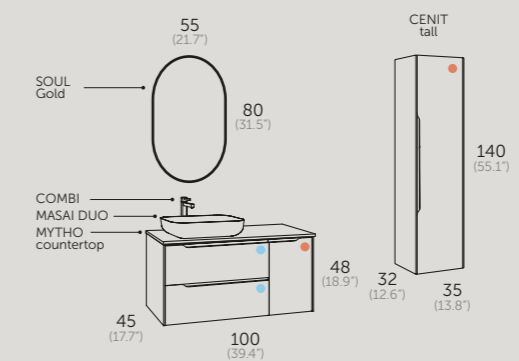

### CENIT 100

- 163 27 100 CENIT 100
- 523 26 051 Masai Duo Flower
- 532 76 100 Mytho Countertop Carrara / Abdeckung / Piano
- 425 14 100 Reinforcement Bar / Waschtischplatten-Stabilisierung / Barra di rinforzo
- 239 72 080 Soul Gold
- 163 27 340 CENIT Tall White / Hoch / Alto
- 412 00 807 Combi Tall Gold / Hoch / Alto



- Matte White
- Matte Mink
- Matte Mist
- Matte Blue Space

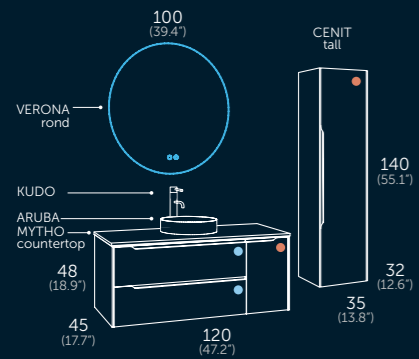

## CENIT 120 CENTERED SINK

- 163 46 121 Cenit 120 centered sink / Zentriert / Centrato
- 532 77 120 Mytho Countertop Marquina Storm / Abdeckung / Piano
- 425 14 120 Reinforcement Bar / Waschtischplatten-Stabilisierung / Barra di rinforzo
- 581 77 037 Aruba Marquina Storm
- 247 00 100 Verona Rond
- 163 46 340 Cenit Tall Mink / Hoch / Alto
- 412 02 815 Kudo Tall Black / Hoch / Alto

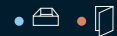

-  Metal interior drawers. Metallzieleiste.  
Sistema di estrazione metallico.
-  Total extraction. Vollauszug.  
Estrazione totale.
-  Organizer unit. Utensilien Behälter.  
Organizzatore.
-  Soft close. Soft-close-System.  
Chiusura ammortizzata.
-  GRASS Grass sliding system. Korpuschiene  
Grass. Guide Grass.
-  Soft close. Soft-close-System.  
Chiusura ammortizzata.
-  Matte lacquered finish. Matt lackiert.  
Laccato opaco.
-  Anti fog system. Anti-Beschlag-System.  
Sistema antiappannamento.
-  Ambient light. Umgebungslicht.  
Luce ambiente.
-  Intensity control. Intensitätsregler.  
Regolatore di intensità.
-  Dual sensor On/Off-anti fog. Doppelter  
Sensorschalter. On/Off. Doppio sensore  
di con tatto. On/Off. Antihappannante.

- Matte White
- Matte Mink
- Matte Mist
- Matte Blue Space



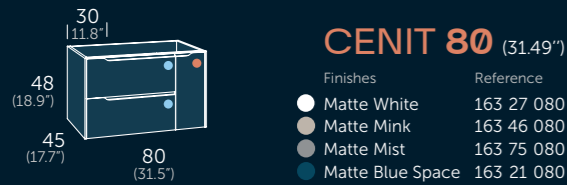

### CENIT 80 (31.49")

- | Finishes           | Reference  |
|--------------------|------------|
| ● Matte White      | 163 27 080 |
| ● Matte Mink       | 163 46 080 |
| ● Matte Mist       | 163 75 080 |
| ● Matte Blue Space | 163 21 080 |



- |  |   |  |  |
|--|---|--|--|
| <b>ONIX NEW</b> ceramic<br>Reference<br>● Glossy White<br>550 01 081<br>● Matte Colour<br>552 XX 081 | <b>AMBAR / MARA</b><br>Reference<br>● Solid Surface<br>506 01 081<br>● Resin Colour<br>540 XX 081 | <b>AMBAR / MARA</b> countertop<br>Reference<br>● Solid Surface<br>508 01 080<br>● Resin Colour<br>542 XX 080 | <b>MYTHO</b> marquina storm<br>Reference<br>● Carrara<br>532 76 080<br>● Marquina Storm<br>532 77 080<br>● Pure Cement<br>532 95 080 |
|--|---|--|--|



- |  |   |  |  |
|--|---|--|--|
| <b>ONIX NEW</b> ceramic<br>Reference<br>● Glossy White<br>550 01 101 | <b>AMBAR / MARA</b><br>Reference<br>● Solid Surface<br>506 01 107<br>● Resin Colour<br>540 XX 101 | <b>AMBAR / MARA</b> countertop<br>Reference<br>● Solid Surface<br>508 01 100<br>● Resin Colour<br>542 XX 100 | <b>MYTHO</b> marquina storm<br>Reference<br>● Carrara<br>532 76 100<br>● Marquina Storm<br>532 77 100<br>● Pure Cement<br>532 95 100 |
|--|---|--|--|



- |  |   |  |  |
|--|---|--|--|
| <b>ONIX NEW</b> ceramic<br>Reference<br>● Glossy White<br>550 01 121 | <b>AMBAR / MARA</b><br>Reference<br>● Solid Surface<br>506 01 121<br>● Resin Colour<br>540 XX 121 | <b>AMBAR / MARA</b> countertop<br>Reference<br>● Solid Surface<br>508 01 120<br>● Resin Colour<br>542 XX 120 | <b>MYTHO</b> marquina storm<br>Reference<br>● Carrara<br>532 76 120<br>● Marquina Storm<br>532 77 120<br>● Pure Cement<br>532 95 120 |
|--|---|--|--|



- |  |   |   |  |
|--|---|---|--|
| <b>ONIX NEW</b> ceramic<br>Reference<br>● Glossy White<br>550 01 120 | <b>AMBAR / MARA</b><br>Reference<br>● Solid Surface<br>506 01 120<br>● Resin Colour<br>540 XX 120 | <b>ZEN / IRIS</b><br>Reference<br>● Solid Surface<br>555 01 120<br>● Resin Colour<br>536 XX 120 | <b>AMBAR/MARA</b> plinthead countertop<br>Reference<br>● Solid Surface<br>525 01 120<br>● Resin Colour<br>541 XX 120 |
|--|---|---|--|



- |   |  |   |   |  |
|---|--|---|---|--|
| <b>ESTAMBUL</b> ceramic<br>Referencia<br>● Glossy White<br>507 01 005 | <b>OTTO</b> ceramic<br>Reference<br>● Glossy White<br>530 01 008<br>● Matte Colour<br>535 XX 008 | <b>OVAL/ORBIT</b><br>Reference<br>● Solid Surface<br>509 01 001<br>● Resin Colour<br>518 XX 057 | <b>CORINTO/BARBADOS</b><br>Reference<br>● Solid Surface<br>582 01 037<br>● Resin Colour<br>583 XX 037 | <b>CURAZAO</b> resin deco<br>Reference<br>● Carrara<br>585 76 034<br>● Marquina Storm<br>585 77 034<br>● Pure Cement<br>585 95 034 |
|---|--|---|---|--|

**REINFORCEMENT BAR ALUMINIUM**

cm	Reference
80	425 14 080
100	425 14 100
120	425 14 120

To avoid deformation of the lids, it is necessary to install the reinforcement bar in the module where the basin will be supported.  
Um eine Verformung des Waschtischplatten zu vermeiden, ist es notwendig eine Waschtischplatten-Stabilisierung in dem Modul zu installieren, auf dem das Waschbecken aufliegt.  
Per evitare la deformazione del piano, è necessario installare la barra di rinforzo nel modulo dove il lavabo sarà sostenuto.



**DRILLING SERVICE**  
Plan required.  
Ref: 435 00 050



- |                                       |   |   |  |  |  |  |   |
|---------------------------------------|---|---|--|--|--|--|---|
| <b>SUN</b><br>Reference<br>204 00 080 | <b>NITRO</b><br>Reference<br>241 00 080 | <b>SOUL</b><br>Reference<br>● BLACK<br>239 02 090<br>● GOLD<br>239 72 090 | <b>RAIN LED</b><br>Reference<br>269 00 080 | <b>JAZZ LED</b><br>Reference<br>271 02 050 | <b>COSMOS LED</b><br>Reference<br>270 00 080 | <b>VERONA LED</b><br>Reference<br>246 00 080 | <b>SKYLINE 80</b> cabinet<br>Reference<br>● Matte Mink<br>341 46 080<br>● Blue Space<br>341 21 080<br>2 Doors |
|---------------------------------------|---|---|--|--|--|--|---|



- |                                       |   |   |  |  |  |  |  |
|---------------------------------------|---|---|--|--|--|--|--|
| <b>SUN</b><br>Reference<br>204 00 100 | <b>NITRO</b><br>Reference<br>241 00 100 | <b>SOUL</b><br>Reference<br>● BLACK<br>239 02 080<br>● GOLD<br>239 72 080 | <b>RAIN LED</b><br>Reference<br>269 00 100 | <b>AURA LED</b><br>Reference<br>250 02 070 | <b>COSMOS LED</b><br>Reference<br>270 00 100 | <b>VERONA LED</b><br>Reference<br>246 00 100 | <b>SKYLINE 100</b> cabinet<br>Reference<br>● Matte Mink<br>341 46 100<br>● Blue Space<br>341 21 100<br>3 Doors |
|---------------------------------------|---|---|--|--|--|--|--|



- |                                       |   |  |  |  |  |  |  |
|---------------------------------------|---|--|--|--|--|--|--|
| <b>SUN</b><br>Reference<br>204 00 120 | <b>NITRO</b><br>Reference<br>241 00 060 | <b>SOUL</b><br>Reference<br>239 00 090 | <b>RAIN LED</b><br>Reference<br>269 00 120 | <b>AURA STRAP LED</b><br>Reference<br>251 02 060 | <b>COSMOS LED</b><br>Reference<br>270 00 120 | <b>VERONA LED</b><br>Reference<br>246 00 060 | <b>SKYLINE 120</b> cabinet<br>Reference<br>● Matte Mink<br>341 46 120<br>● Blue Space<br>341 21 120<br>3 Doors |
|---------------------------------------|---|--|--|--|--|--|--|



- |                                       |   |  |  |   |   |  |
|---------------------------------------|---|--|--|---|---|--|
| <b>SUN</b><br>Reference<br>204 00 060 | <b>NITRO</b><br>Reference<br>241 00 120 | <b>SOUL</b><br>Reference<br>239 00 080 | <b>RAIN LED</b><br>Reference<br>269 00 060 | <b>TOWER LED</b><br>Reference<br>262 00 120 | <b>SPOTY LED</b><br>Reference<br>267 00 120 | <b>VERONA LED</b><br>Reference<br>246 00 120 |
|---------------------------------------|---|--|--|---|---|--|



- |  |   |   |   |
|--|---|---|---|
| <b>KUDO</b> tap<br>Reference<br>● Brushed Steel<br>412 04 810<br>● Black<br>412 02 810<br>● Brushed Gold<br>412 03 810<br>● Full Color<br>412 XX 811 | <b>COMBI TALL</b> tap<br>Reference<br>● Chrome<br>585 76 805<br>● Black<br>412 00 806<br>● Gold<br>412 00 807<br>● Full Color<br>412 XX 804 | <b>DRAIN</b> clic clac<br>Reference<br>● Chrome<br>409 00 203<br>● Black<br>410 02 203<br>● White<br>410 01 203<br>● Brushed Gold<br>410 03 203<br>● Colour<br>409 XX 203 | <b>ESTHER BLACK 45</b><br>Reference<br>400 02 191 |
|--|---|---|---|

Replace the XX by the chosen colour code. See codes on page 447.  
Ersetzen Sie XX durch den Code der ausgewählten Farbe. Siehe Seite 447 für Farbcodes.  
Sostituire l'XX con il codice colore scelto. Vedere i codici a pagina 447.

### SPECIAL DRAWER SPEZIALSCHUBLADE / CASSETTO SPECIALE

Check all the information on page 429.  
Konsultieren Sie alle Informationen auf Seite 429.  
Consulta tutte le informazioni nella pagina 429.

**WITHOUT SIPHON CUTOUT**  
/ OHNE SIPHON / SENZA SIFONE  
Ref: 432 00 000

**REINFORCEMENT BAR ALUMINIUM**

cm	Reference
80	425 14 080
100	425 14 100
120	425 14 120

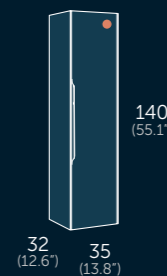

### CENIT TALL

- | Finishes           | Reference  |
|--------------------|------------|
| ● Matte White      | 163 27 340 |
| ● Matte Mink       | 163 46 340 |
| ● Matte Mist       | 163 75 340 |
| ● Matte Blue Space | 163 21 340 |
- Reversible opening | Umkehrbare Öffnung | Apertura reversibile



# BERLÍN

60 | 70 | 80 | 100





Metal interior drawers. Metallzierleiste.  
Sistema di estrazione metallico.



Total extraction. Vollauszug  
Estrazione totale.



Organizer unit. Utensilien Behälter.  
Organizzatore.



Soft close. Soft-close-System.  
Chiusura ammortizzata.



Grass sliding system. Korpuschiene  
Grass. Guide Grass.



Soft close. Soft-close-System.  
Chiusura ammortizzata.

## BERLÍN 80

143 24 080 Berlín 80  
550 01 080 Onix New  
244 72 080 Rond Gold  
142 24 335 Oslo Tall Natural Oak / Hoch / Alto  
412 00 802 Combi Gold

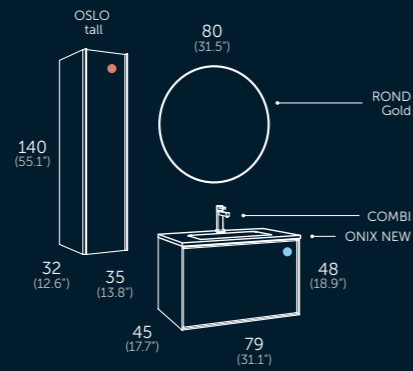

Matte White Natural Oak



### BERLÍN 60

- 143 27 060 Berlin 60
- 138 24 120 Flow 120 f46 Natural Oak
- 581 25 037 Aruba Leaf
- 271 02 050 Jazz
- 112 24 520 Shelf L Natural Oak / Regal L / Scaffale L
- 112 47 505 Shelf Horizontal Leaf / Horizontales Regal / Scaffale Orizzontale
- 412 02 808 Combi Wall-Mounted Black

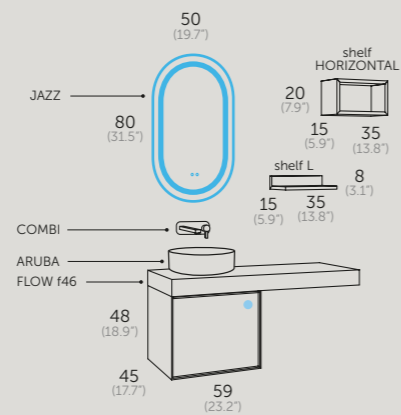

- Metal interior drawers. Metallzierleiste. Sistema di estrazione metallico.
- Total extraction. Vollauszug. Estrazione totale.
- Organizer unit. Utensilien Behälter. Organizzatore.
- Soft close. Soft-close-System. Chiusura ammortizzata.
- GRASS. Grass sliding system. Korpuschiene. Grass. Guide Grass.
- Matte lacquered finish. Matt lackiert. Laccato opaco.
- Anti fog system. Anti-Beschlag-System. Sistema antiappannamento.
- Ambient light. Umgebungslicht. Luce ambiente.
- Intensity control. Intensitätsregler. Regolatore di intensità.
- Dual sensor On/Off-anti fog. Doppelter Sensorschalter. On/Off. Doppio sensore di con tatto. On/Off. Antiappannante.



### BERLÍN 100

- 143 27 100 Berlin 100
- 542 08 100 Mara Countertop Sunset / Abdeckung / Piano towel rail increase / Verlängerung des Handtuchhalter / allargamento del portasciugamani
- 425 14 100 Reinforcement Bar / Waschtischplatten-Stabilisierung / Barra di rinforzo
- 509 01 052 Milos
- 247 00 100 Verona Rond
- 412 08 805 Combi Tall Chrome - Sunset / Hoch / Alto

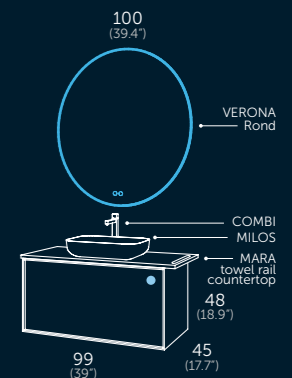

Matte White Natural Oak



### BERLÍN 60 (23.62")

48 (18.9")  
45 (17.7")  
59 (23.2")

Finishes Reference  
● Matte White 143 27 060  
● Natural Oak 143 24 060

<b>ONIX NEW</b> ceramic Reference ● Glossy White 550 01 060 ● Matte Colour 552 XX 060	<b>AMBAR / MARA</b> Reference ● Solid Surface 506 01 060 ● Resin Colour 540 XX 060	<b>ZEN / IRIS</b> Reference ● Solid Surface 555 01 060 ● Resin Colour 536 XX 060	<b>QUATTRO</b> ceramic Reference ● Glossy White 522 01 060	<b>AMBAR / MARA</b> countertop Reference ● Solid Surface 508 01 060 ● Resin Colour 542 XX 060
--	---	---	--	--

<b>SUN</b> Reference 204 00 060	<b>SOUL</b> Reference 239 00 090	<b>ROND</b> Reference ● BLACK 244 02 060 ● GOLD 244 72 060	<b>RAIN LED</b> Reference 269 00 060	<b>VERONA LED</b> Reference 246 00 060	<b>JAZZ LED</b> Reference 271 02 050	<b>AURA STRAP LED</b> Reference 251 02 060	<b>ORION / OSIRIS LED</b> Reference ● Solid Surface 210 01 060 ● Resin Colour 211 XX 060
------------------------------------	-------------------------------------	---	---	---	---	---	---

### BERLÍN 70 (27.55")

48 (18.9")  
45 (17.7")  
69 (27.5")

Finishes Reference  
● Matte White 143 27 070  
● Natural Oak 143 24 070

<b>ONIX NEW</b> ceramic Reference ● Glossy White 550 01 070 ● Matte Colour 552 XX 070	<b>AMBAR / MARA</b> Reference ● Solid Surface 506 01 070 ● Resin Colour 540 XX 070	<b>ZEN / IRIS</b> Reference ● Solid Surface 555 01 070 ● Resin Colour 536 XX 070	<b>AMBAR / MARA</b> plinthed Reference ● Solid Surface 524 01 070 ● Resin Colour 541 XX 070	<b>AMBAR / MARA</b> countertop Reference ● Solid Surface 508 01 070 ● Resin Colour 542 XX 070
--	---	---	--	--

<b>SUN</b> Reference 204 00 070	<b>SOUL</b> Reference 239 00 080	<b>ROND</b> Reference ● BLACK 244 02 070 ● GOLD 244 72 070	<b>RAIN LED</b> Reference 269 00 070	<b>VERONA LED</b> Reference 246 00 070	<b>VERONA ROND LED</b> Reference 247 00 070	<b>AURA LED</b> Reference 250 02 070	<b>AURA STRAP LED</b> Reference 251 02 070
------------------------------------	-------------------------------------	---	---	---	--	---	---

### BERLÍN 80 (31.49")

48 (18.9")  
45 (17.7")  
79 (31.1")

Finishes Reference  
● Matte White 143 27 080  
● Natural Oak 143 24 080

<b>ONIX NEW</b> ceramic Reference ● Glossy White 550 01 080 ● Matte Colour 552 XX 080	<b>AMBAR / MARA</b> Reference ● Solid Surface 506 01 080 ● Resin Colour 540 XX 080	<b>ZEN / IRIS</b> Reference ● Solid Surface 555 01 080 ● Resin Colour 536 XX 080	<b>QUATTRO</b> ceramic Reference ● Glossy White 522 01 080	<b>AMBAR / MARA</b> countertop Reference ● Solid Surface 508 01 080 ● Resin Colour 542 XX 080
--	---	---	--	--

<b>SUN</b> Reference 204 00 080	<b>NITRO</b> Reference 241 00 080	<b>ROND</b> Reference ● BLACK 244 02 080 ● GOLD 244 72 080	<b>COSMOS LED</b> Reference 270 00 080	<b>VERONA LED</b> Reference 246 00 080	<b>VERONA ROND LED</b> Reference 247 00 080	<b>AURA LED</b> Reference 250 02 080	<b>ORION / OSIRIS LED</b> Reference ● Solid Surface 210 01 080 ● Resin Colour 211 XX 080
------------------------------------	--------------------------------------	---	---	---	--	---	---

### BERLÍN 100 (39.37")

48 (18.9")  
45 (17.7")  
99 (39")

Finishes Reference  
● Matte White 143 27 100  
● Natural Oak 143 24 100

<b>ONIX NEW</b> ceramic Reference ● Glossy White 550 01 100	<b>AMBAR / MARA</b> Reference ● Solid Surface 506 01 100 ● Resin Colour 540 XX 100	<b>ZEN / IRIS</b> Reference ● Solid Surface 555 01 100 ● Resin Colour 536 XX 100	<b>QUATTRO</b> ceramic Reference ● Glossy White 522 01 100	<b>AMBAR / MARA</b> countertop Reference ● Solid Surface 508 01 100 ● Resin Colour 542 XX 100
---	---	---	--	--

<b>SUN</b> Reference 204 00 100	<b>NITRO</b> Reference 241 00 100	<b>ROND</b> Reference ● BLACK 244 02 100 ● GOLD 244 72 100	<b>COSMOS LED</b> Reference 270 00 100	<b>VERONA LED</b> Reference 246 00 100	<b>MILOS/MASAI</b> Reference ● Solid Surface 509 01 052 ● Resin Colour 518 XX 051	<b>OTTO</b> ceramic Reference ● Glossy White 530 01 008 ● Matte Colour 535 XX 008	<b>CURAZAO</b> resin deco Reference ● Carrara 585 76 034 ● Marquina Storm 585 77 034 ● Pure Cement 585 95 034
------------------------------------	--------------------------------------	---	---	---	--	--	---

over countertop basins / Aufsatzwaschbecken / lavabi da appoggio

### SPECIAL DRAWER

SPEZIALSCHUBLADE / CASSETTO SPECIALE

Check all the information on page 429.  
Konsultieren Sie alle Informationen auf Seite 429.  
Consulta tutte le informazioni nella pagina 429.

#### OFFSET SIPHON CUTOUT

VERSCHIEBBARER SIPHON / SIFONE REGOLABILE  
Ref: 432 00 001

A plan is required. Not available for the 60 cm size.  
Plan erforderlich. Nicht verfügbar für die Größe 60 cm.  
Piano richiesto. Non disponibile per la misura da 60 cm.

#### WITHOUT SIPHON CUTOUT

OHNE SIPHON / SENZA SIFONE  
Ref: 432 00 000

### LANDES COUNTERTOP

Reinforcement Bar not included.  
Verstärkungsstange nicht enthalten.  
Barra di rinforzo non inclusa.

cm	Natural Oak
60	112 24 206
70	112 24 207
80	112 24 208
100	112 24 210

cm	Reference
60	425 14 060
70	425 14 070
80	425 14 080
100	425 14 100

#### REINFORCEMENT BAR ALUMINIUM

To avoid deformation of the lids, it is necessary to install the reinforcement bar in the module where the basin will be supported. Um eine Verformung der Abdeckung zu vermeiden, ist es notwendig eine Waschtischplatten-Stabilisierung in dem Modul zu installieren, auf dem das Waschbecken aufliegt. Per evitare la deformazione del piano, è necessario installare la barra di rinforzo nel modulo dove il lavabo sarà sostenuto.

#### DRILLING SERVICE

Plan required.  
Ref: 435 00 050

### FLOW F46

Invisible brackets with leveling included.  
Verdeckte Befestigung mit Nivellierung inbegriffen.  
Staffe invisibili con livellamento incluso.

cm	Natural Oak
60	138 24 060
70	138 24 070
80	138 24 080
100	138 24 100
120	138 24 120
140	138 24 140

accessories / Zubehör / complementi

<b>COMBI</b> tap Reference ● Chrome 412 00 800 ● Black 412 00 801 ● Gold 412 00 802 ● Full Color 412 XX 803	<b>KUDO TALL</b> tap Reference ● Steel 412 04 815 ● Black 412 02 815 ● Brushed Gold 412 03 815 ● Colour 412 XX 816	<b>DRAIN</b> clic clac Reference ● Chrome 409 00 203 ● Black 410 02 203 ● White 410 01 203 ● Brushed Gold 410 03 203 ● Colour 409 XX 203	<b>LUX 38</b> towel rail Reference ● Chrome 417 00 038 ● Black 417 02 038 ● White 417 27 038	<b>ESTHER BLACK 30</b> Reference 400 02 141
--	---	--	--	--

Replace the XX by the chosen colour code. See codes on page 447.  
Ersetzen Sie XX durch den Code der ausgewählten Farbe. Siehe Seite 447 für Farbcodes.  
Sostituire l'XX con il codice colore scelto. Vedere i codici a pagina 447.

side cabinet / Hängeschränke / armadi

### OSLO TALL

Finishes Reference  
● Matte White 142 27 335  
● Natural Oak 142 24 335

Reversible opening | Umkehrbare Öffnung | Apertura reversibile

32 (12.6")  
35 (13.8")  
140 (55.1")



# TOSCANA

60 | 80 | 100



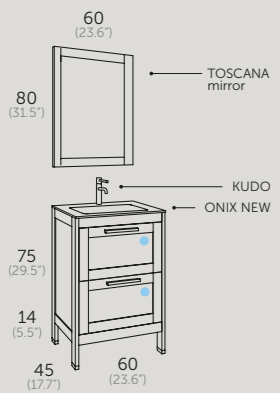

### TOSCANA 60

197 49 060 C Toscana 60  
 550 01 060 Onix New  
 296 49 060 Toscana Mirror / Spiegel / Specchio total

412 04 810 Kudo Brushed Steel / Gebürstet / Spazzolato









#### FURNITURE

Matte White Natural Oak Matte Mist Matte Island

#### HANDLES AND LEGS

Matte Chrome Matte Black Matte Gold

-  Metal interior drawers.  
Metallzierleiste.  
Sistema di estrazione metallico.
-  Total extraction.  
Vollauszug.  
Estrazione totale.
-  Organizer unit.  
Utensilien Behälter.  
Organizzatore.
-  Soft close.  
Soft-close-System.  
Chiusura ammortizzata.
-  GRASS  
Grass sliding system.  
Körpuschiene Grass.  
Guide Grass.
-  Soft close.  
Soft-close-System.  
Chiusura ammortizzata.

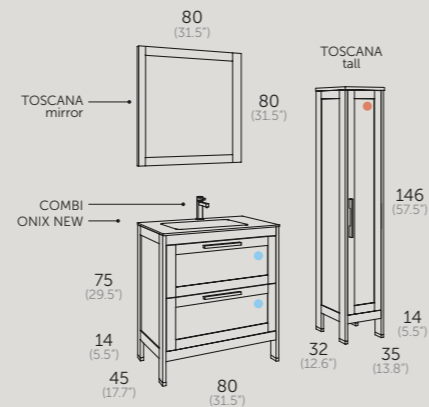

### TOSCANA 80





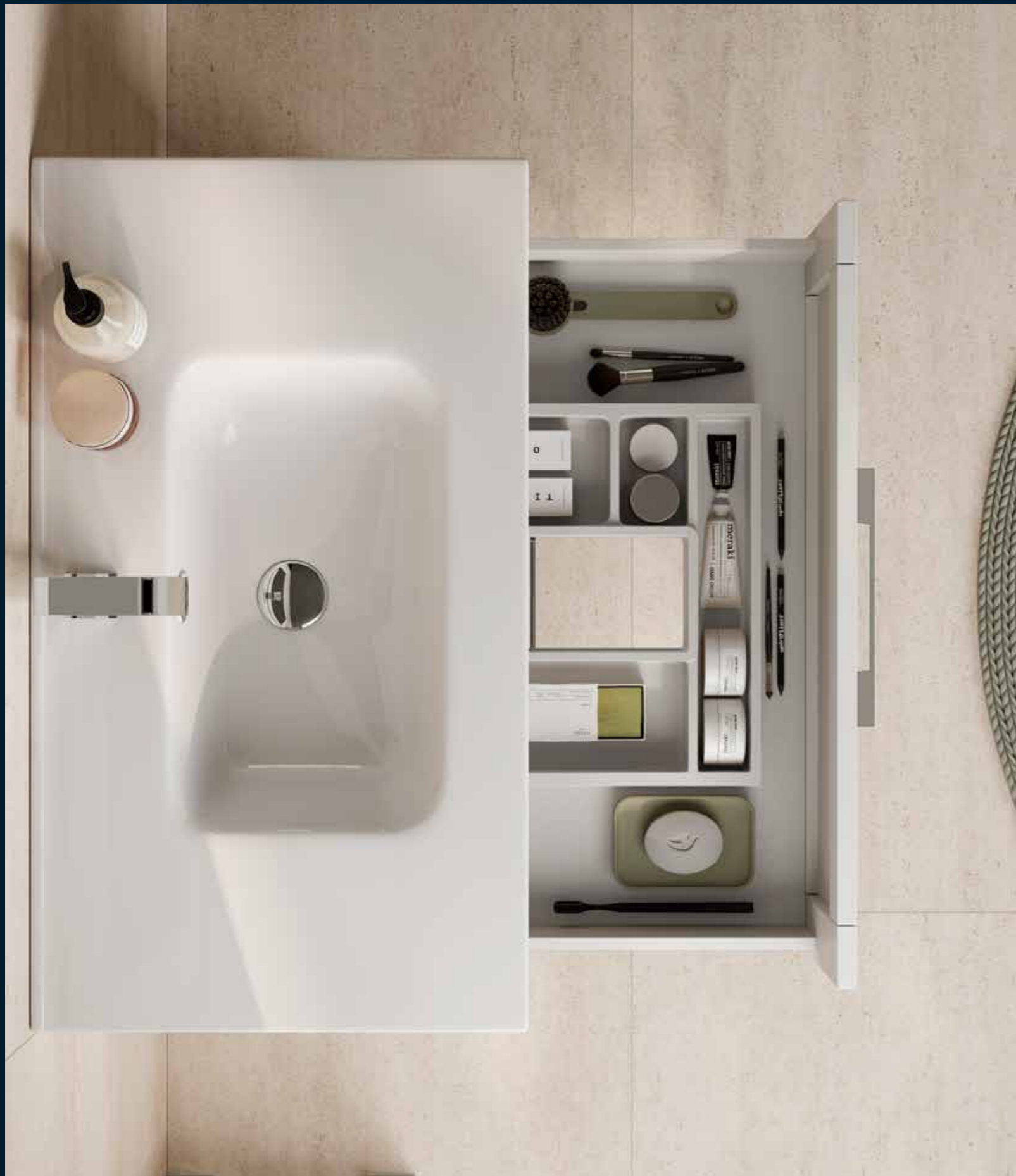

197 49 080 N Toscana 80  
 550 01 080 Onix New  
 296 24 080 Toscana Mirror / Spiegel / Specchio total

197 24 335 N Toscana Natural Oak Tall / Hoch / Alto

412 00 801 Combi Black





-  Metal interior drawers. Metallzierleiste. Sistema di estrazione metallico.
-  Total extraction. Vollauszug. Estrazione totale.
-  Organizer unit. Utensilien Behälter. Organizzatore.
-  Soft close. Soft-close-System. Chiusura ammortizzata.
-  GRASS Grass sliding system. Korpuschiene Grass. Guide Grass.
-  Soft close. Soft-close-System. Chiusura ammortizzata.



## TOSCANA 80

197 35 080 C Toscana 80  
 550 01 080 Onix New  
 296 35 080 Toscana Mirror / Spiegel / Specchio total

197 35 335 C Toscana White Tall / Hoch / Alto

412 00 800 Combi Chrome

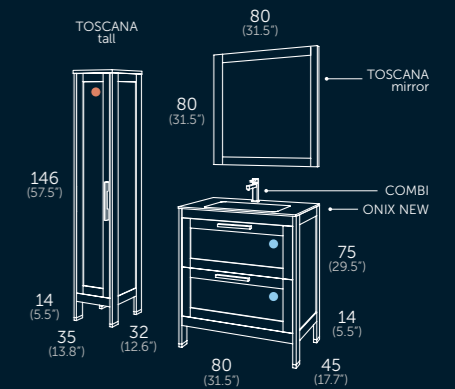
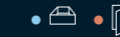







### FURNITURE

Matte White Natural Oak Matte Mist Matte Island

### HANDLES AND LEGS

Matte Chrome Matte Black Matte Gold



-  Metal interior drawers.  
Metallzierleiste.  
Sistema di estrazione metallico.
-  Total extraction.  
Vollauszug.  
Estrazione totale.
-  Organizer unit.  
Utensilien Behälter.  
Organizator.
-  Soft close.  
Soft-dose-System.  
Chiusura ammortizzata.
-  GRASS  
Grass sliding system.  
Körpuschiene Grass.  
Guide Grass.
-  SOFT  
Soft close.  
Soft-dose-System.  
Chiusura ammortizzata.

FURNITURE

- Matte White
  - Natural Oak
  - Matte Mist
  - Matte Island
- HANDLES AND LEGS
- Matte Chrome
  - Matte Black
  - Matte Gold

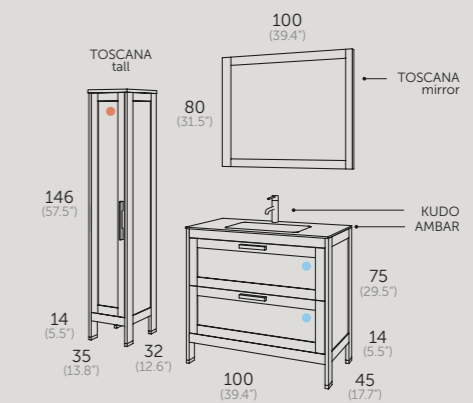

**TOSCANA 100**

- 197 71 100 N Toscana 100
- 506 01 100 Ambar
- 296 71 100 Toscana Mirror / Spiegel / Specchio total
- 197 71 335 N Toscana Tall Mist / Hoch / Alto
- 412 02 810 Kudo Black





### TOSCANA 60 (23.62")

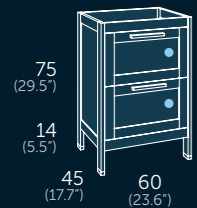

- Finishes Reference
- Matte White 197 35 060 (X)
  - Natural Oak 197 24 060 (X)
  - Matte Mist 197 71 060 (X)
  - Matte Island 197 49 060 (X)

Replace X with the color reference for the handles and legs:  
Ersetzen Sie X durch die Farbreferenz für Griffe und Beine:  
Sostituire la X con il riferimento colore di maniglie e gambe:

- Chrome (C) ● Black (N) ● Gold (G)

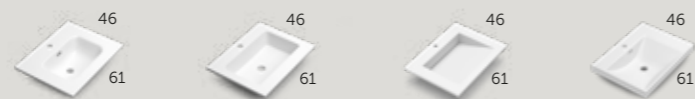

- |  |   |   |  |
|--|---|---|--|
| <b>ONIX NEW</b> ceramic<br>Reference<br>● Glossy White 550 01 060<br>● Matte Colour 552 XX 060 | <b>AMBAR / MARA</b><br>Reference<br>● Solid Surface 506 01 060<br>● Resin Colour 540 XX 060 | <b>ZEN / IRIS</b><br>Reference<br>● Solid Surface 555 01 060<br>● Resin Colour 536 XX 060 | <b>QUATTRO</b> ceramic<br>Reference<br>● Glossy White 522 01 060 |
|--|---|---|--|

### TOSCANA 80 (31.49")

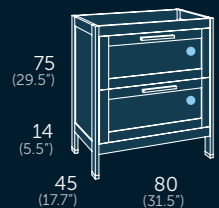

- Finishes Reference
- Matte White 197 35 080 (X)
  - Natural Oak 197 24 080 (X)
  - Matte Mist 197 71 080 (X)
  - Matte Island 197 49 080 (X)

Replace X with the color reference for the handles and legs:  
Ersetzen Sie X durch die Farbreferenz für Griffe und Beine:  
Sostituire la X con il riferimento colore di maniglie e gambe:

- Chrome (C) ● Black (N) ● Gold (G)



- |  |   |   |  |
|--|---|---|--|
| <b>ONIX NEW</b> ceramic<br>Reference<br>● Glossy White 550 01 080<br>● Matte Colour 552 XX 080 | <b>AMBAR / MARA</b><br>Reference<br>● Solid Surface 506 01 080<br>● Resin Colour 540 XX 080 | <b>ZEN / IRIS</b><br>Reference<br>● Solid Surface 555 01 080<br>● Resin Colour 536 XX 080 | <b>QUATTRO</b> ceramic<br>Reference<br>● Glossy White 522 01 080 |
|--|---|---|--|

### TOSCANA 100 (39.37")

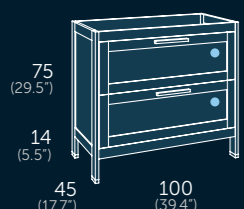

- Finishes Reference
- Matte White 197 35 100 (X)
  - Natural Oak 197 24 100 (X)
  - Matte Mist 197 71 100 (X)
  - Matte Island 197 49 100 (X)

Replace X with the color reference for the handles and legs:  
Ersetzen Sie X durch die Farbreferenz für Griffe und Beine:  
Sostituire la X con il riferimento colore di maniglie e gambe:

- Chrome (C) ● Black (N) ● Gold (G)



- |   |   |   |  |
|---|---|---|--|
| <b>ONIX NEW</b> ceramic<br>Reference<br>● Glossy White 550 01 100 | <b>AMBAR / MARA</b><br>Reference<br>● Solid Surface 506 01 100<br>● Resin Colour 540 XX 100 | <b>ZEN / IRIS</b><br>Reference<br>● Solid Surface 555 01 100<br>● Resin Colour 536 XX 100 | <b>QUATTRO</b> ceramic<br>Reference<br>● Glossy White 522 01 100 |
|---|---|---|--|



- |   |   |  |   |   |
|---|---|--|---|---|
| <b>COMBI</b> tap<br>Reference<br>● Chrome 412 00 800<br>● Black 412 00 801<br>● Gold 412 00 802 | <b>KUDO</b> tap<br>Reference<br>● Brushed Steel 412 04 810<br>● Black 412 02 810<br>● Brushed Gold 412 03 810 | <b>WALL-MOUNTED</b> tap<br>Reference<br>● Chrome 412 00 808<br>● Black 412 02 808<br>● Gold 412 03 808 | <b>DRAIN clic clac</b><br>Reference<br>● Chrome 409 00 203<br>● Black 410 02 203<br>● White 410 01 203<br>● Brushed Gold 410 03 203 | <b>ADHESIVE 3M</b> towel rail<br>Reference<br>● Chrome 416 00 037<br>● Black 416 02 037 |
|---|---|--|---|---|

Replace the XX by the chosen colour code. See codes on page 447.  
Ersetzen Sie XX durch den Code der ausgewählten Farbe. Siehe Seite 447 für Farbcodes.  
Sostituire l'XX con il codice colore scelto. Vedere i codici a pagina 447.

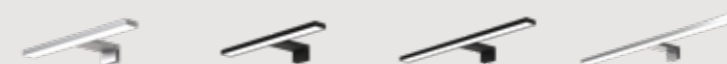

- |  |   |   |  |
|--|---|---|--|
| <b>NEREA MATTE 30</b><br>Reference<br>400 14 141 | <b>ESTHER BLACK 30</b><br>Reference<br>400 02 141 | <b>ESTHER BLACK 45</b><br>Reference<br>400 02 191 | <b>SOFIA 60</b><br>Reference<br>400 00 141 |
|--|---|---|--|



### TALL

- Finishes Reference
- Matte White 197 35 335 (X)
  - Natural Oak 197 24 335 (X)
  - Matte Mist 197 71 335 (X)
  - Matte Island 197 49 335 (X)

Reversible opening | Umkehrbare Öffnung | Apertura reversibile

Replace X with the color reference for the handles and legs:  
Ersetzen Sie X durch die Farbreferenz für Griffe und Beine:  
Sostituire la X con il riferimento colore di maniglie e gambe:

- Chrome (C) ● Black (N) ● Gold (G)

### SPECIAL DRAWER

#### SPEZIALSCHUBLADE / CASSETTO SPECIALE

Check all the information on page 429.  
Konsultieren Sie alle Informationen auf Seite 429.  
Consulta tutte le informazioni nella pagina 429.

#### OFFSET SIPHON CUTOUT VERSCHIEBBARER SIFON / SIFONE REGOLABILE

Ref: 432 00 001  
A plan is required. Not available for the 60 cm size.  
Plan erforderlich. Nicht verfügbar für die Größe 60 cm.  
Piano richiesto. Non disponibile per la misura da 60 cm.

#### WITHOUT SIPHON CUTOUT OHNE SIFON / SENZA SIFONE

Ref: 432 00 000

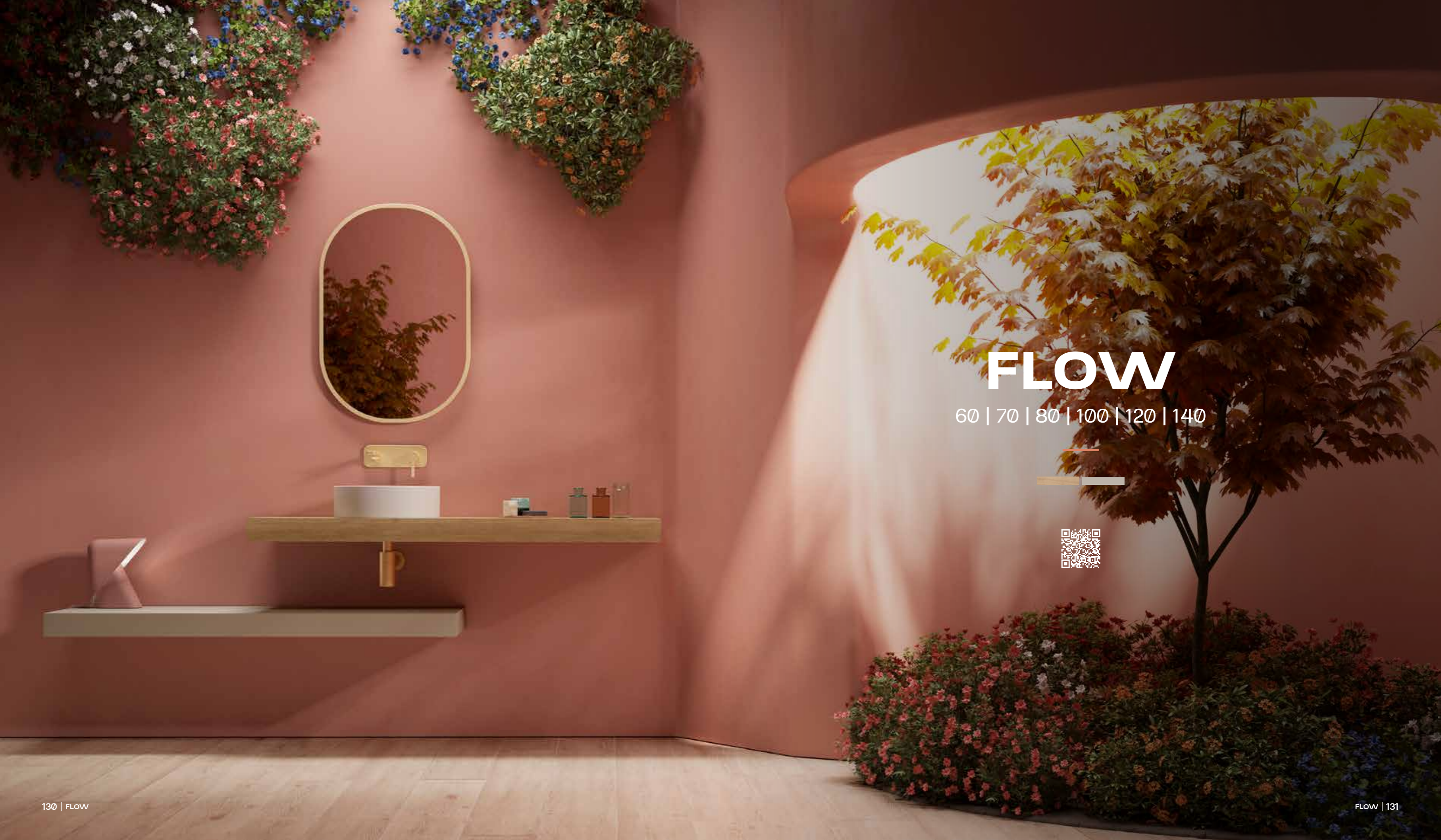

# FLOW

60 | 70 | 80 | 100 | 120 | 140





Anti fog system.  
Anti-Beschlag-System.  
Sistema antiappannamento.



Dual sensor On/Off-anti fog.  
Doppelter Sensorschalter. On/Off.  
Doppio sensore touch. On/Off.  
Antiappannante.

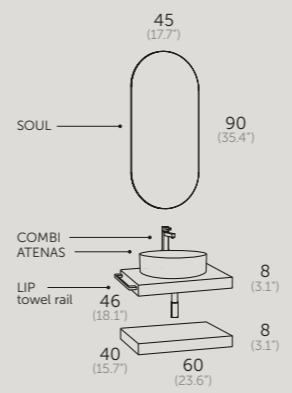

**FLOW 60**

- 138 74 060 Flow 60 f46
- 138 74 061 Flow 60 f40
- 410 00 101 Siphon Chrome / Siphon / Sifone
- 580 01 037 Atenas
- 239 00 090 Soul
- 416 00 003 Lip Towel rail 40 / Handtuchhalter / Portasciugamani
- 412 00 805 Combi Tall Chrome

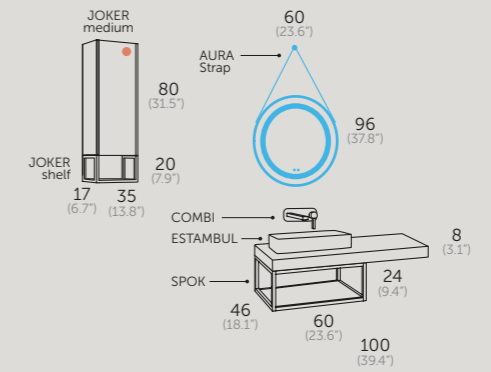

**FLOW 100**

- 138 24 100 Flow 100 f46
- 165 24 060 Spok 60
- 410 02 101 Black Siphon / Siphon / Sifone
- 507 01 005 Estambul
- 251 02 060 Aura Strap
- 137 24 435 Joker Medium Natural Oak / Mittel / Medio
- 137 24 455 Joker Shelf Natural Oak / Regal / Scaffale
- 412 02 808 Combi Wall-Mounted Black





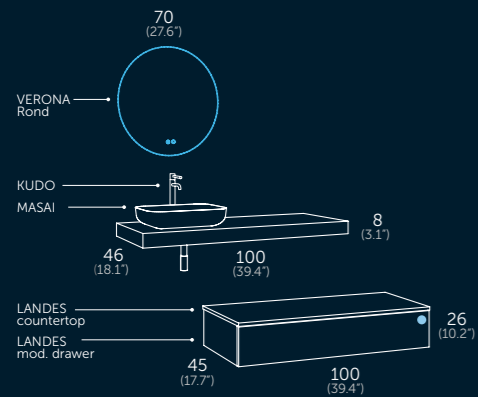





Natural Oak    Matte Mink



## FLOW 100

138	24	100	Flow 100 f46
410	02	101	Black Siphon / Siphon / Sifone
112	24	104 LN	Landes Module Drawer Natural Oak / Modul Schublade / Modulo Cassetto
112	24	208	Landes Countertop Natural Oak / Abdeckung / Piano
518	02	051	Masai Black
247	00	070	Verona Rond
412	02	815	Kudo Tall Black







-  Metal interior drawers. Metallzierleiste.  
Sistema di estrazione metallico.
-  Total extraction. Vollauszug.  
Estrazione totale.
-  Soft close. Soft-close-System.  
Chiusura ammortizzata.
-  GRASS Grass sliding system. Korpussschiene  
Grass. Guide Grass.
-  Water resistant. Wasserabweisend.  
Indrorepellente.
-  Anti fog system. Anti-Beschlag-System.  
Sistema antiappannamento.
-  Ambient light. Umgebungslicht.  
Luce ambiente.
-  Dual sensor On/Off-anti fog. Doppelter  
Sensorschalter. On/Off. Doppio sensore  
di con tatto. On/Off. Antihappannante.
-  Intensity control. Intensitätsregler.  
Regolatore di intensità.

Natural Oak    Matte Mink





-  Metal interior drawers.  
Metallzierleiste.  
Sistema di estrazione metallico.
-  Total extraction.  
Vollauszug.  
Estrazione totale.
-  Soft close.  
Soft-close-System.  
Chiusura ammortizzata.
-  GRASS  
Grass sliding system.  
Korpusschiene Grass.  
Guide Grass.
-  Water resistant.  
Wasserabweisend.  
Indrorepellente.
-  Anti fog system.  
Anti-Beschlag-System.  
Sistema antiappannamento.
-  Ambient light.  
Umgebungslicht.  
Luce ambiente.
-  Dual sensor On/Off-anti fog.  
Doppelter Sensorschalter. On/Off.  
Doppio sensore touch. On/Off.  
Antiappannante.

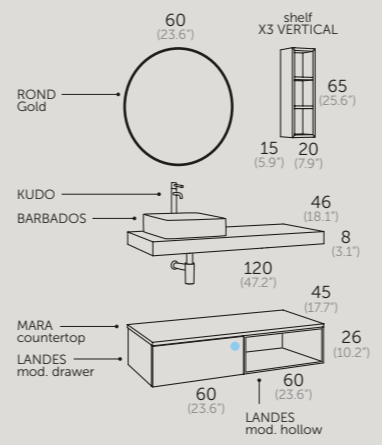

### FLOW 120

- 138 74 120 Flow 120 f46
- 410 03 101 Gold Siphon / Siphon / Sifone
- 112 45 064 LG Landes Module Drawer Anthracite / Modul Schublade / Modulo Cassetto
- 112 45 065 Landes Module Hollow Anthracite / Hohlmodul / Modulo Cavo
- 542 19 120 Mara Countertop Mink / Waschtischplatte / Piano
- 583 19 037 Barbados Mink
- 244 72 060 Rond Gold
- 112 45 500 Shelf X3 Vertical Anthracite / Regal X3 Vertikal / Scaffale X3 Verticale
- 412 03 815 Kudo Tall Brushed Gold / Gebürstet / Spazzolato

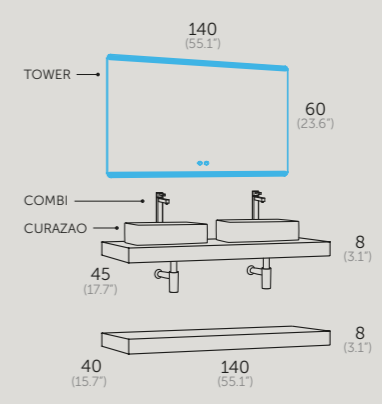

### FLOW 140

- 138 24 140 Flow 140 f46
- 138 24 141 Flow 140 f40
- 410 02 101 Black Siphon / Siphon / Sifone
- 582 10 034 Curazao Blue Space
- 262 00 140 Tower
- 412 00 806 Combi Tall Black / Hoch / Alto

Natural Oak Matte Mink

### FLOW 60 (23.62")

**F46 DEPTH 46 CM**  
Finishes Reference

- Natural Oak 138 24 060
- Matte Mink 138 74 060

**F40 DEPTH 40 CM**  
Finishes Reference

- Natural Oak 138 24 061
- Matte Mink 138 74 061

### FLOW 70 (27.55")

**F46 DEPTH 46 CM**  
Finishes Reference

- Natural Oak 138 24 070
- Matte Mink 138 74 070

**F40 DEPTH 40 CM**  
Finishes Reference

- Natural Oak 138 24 071
- Matte Mink 138 74 071

### FLOW 80 (31.49")

**F46 DEPTH 46 CM**  
Finishes Reference

- Natural Oak 138 24 080
- Matte Mink 138 74 080

**F40 DEPTH 40 CM**  
Finishes Reference

- Natural Oak 138 24 081
- Matte Mink 138 74 081

### FLOW 100 (39.37")

**F46 DEPTH 46 CM**  
Finishes Reference

- Natural Oak 138 24 100
- Matte Mink 138 74 100

**F40 DEPTH 40 CM**  
Finishes Reference

- Natural Oak 138 24 101
- Matte Mink 138 74 101

### FLOW 120 (47.24")

**F46 DEPTH 46 CM**  
Finishes Reference

- Natural Oak 138 24 120
- Matte Mink 138 74 120

**F40 DEPTH 40 CM**  
Finishes Reference

- Natural Oak 138 24 121
- Matte Mink 138 74 121

### FLOW 140 (55.12")

**F46 DEPTH 46 CM**  
Finishes Reference

- Natural Oak 138 24 140
- Matte Mink 138 74 140

**F40 DEPTH 40 CM**  
Finishes Reference

- Natural Oak 138 24 141
- Matte Mink 138 74 141

<b>OTTO ceramic</b> Reference ● Glossy White 530 01 008 ● Matte Colour 535 XX 008	<b>ESTAMBUL ceramic</b> Reference ● Glossy White 507 01 005	<b>ROTTERDAM ceramic</b> Reference ● Glossy White 507 01 004 ● Matte Colour 535 XX 004	<b>TRE 60 ceramic</b> Reference ● Glossy White 530 01 036
--	---	---	---

<b>MILOS/MASAI</b> Reference ● Solid Surface 509 01 052 ● Resin Colour 518 XX 051	<b>OVAL/ORBIT</b> Reference ● Solid Surface 509 01 001 ● Resin Colour 518 XX 057	<b>CORINTO/BARBADOS</b> Reference ● Solid Surface 582 01 037 ● Resin Colour 583 XX 037	<b>ZANTE / SAONA</b> Reference ● Solid Surface 559 01 050 ● Resin Colour 586 XX 049
--	---	---	--

<b>ARUBA resin deco</b> Reference ● Carrara 581 76 037 ● Marquina Storm 581 77 037 ● Pure Cement 581 95 037	<b>CURAZAO resin deco</b> Reference ● Carrara 585 76 034 ● Marquina Storm 585 77 034 ● Pure Cement 585 95 034	<b>BARBADOS resin deco</b> Reference ● Carrara 583 76 037 ● Marquina Storm 583 77 037 ● Pure Cement 583 95 037
---	---	--

<b>COMBI TALL tap</b> Reference ● Chrome 412 00 805 ● Black 412 00 806 ● Gold 412 00 807	<b>COMBI TALL tap</b> Reference ● Full Color 412 XX 804	<b>KUDO TALL tap</b> Reference ● Steel 412 04 815 ● Black 412 02 815 ● Brushed Gold 412 03 815	<b>KUDO TALL tap</b> Reference ● Colour 412 XX 816	<b>WALL-MOUNTED tap</b> Reference ● Chrome 412 00 808 ● Black 412 02 808 ● Gold 412 03 808
--	---	--	--	--

**INVISIBLE BRACKETS**  
VERDECKTE BEFESTIGUNG  
SUPPORTI INVISIBILI

Invisible support systems and screws included.  
Unsichtbare Befestigungssysteme und Schrauben enthalten.  
Sistemi di supporto invisibili e viti inclusi.

<b>SIPHON black</b> Reference ● Chrome 410 00 101 ● Black 410 02 101 ● Brushed Gold 410 03 101	<b>DRAIN clic clac</b> Reference ● Chrome 410 00 203 ● Black 410 02 203 ● Brushed Gold 410 03 203 ● Colour 409 XX 203	<b>LIP towel rail</b> cm Reference 40 416 00 003 60 416 00 002
--	--	---

**DRILLING SERVICE**  
Plan required.  
Ref: 435 00 050

Replace the XX by the chosen colour code. See codes on page 447.  
Ersetzen Sie XX durch den Code der ausgewählten Farbe. Siehe Seite 447 für Farbcodes.  
Sostituire l'XX con il codice colore scelto. Vedere i codici a pagina 447.

### 60 cm (23.62")

<b>SUN</b> Reference 204 00 060	<b>SOUL</b> Reference 239 00 090	<b>ROND</b> Reference ● BLACK 244 02 060 ● GOLD 244 72 060	<b>ROND</b> Reference 244 00 060	<b>AURA STRAP LED</b> Reference 251 02 060	<b>JAZZ LED</b> Reference 271 02 050	<b>VERONA LED</b> Reference 246 00 060
---------------------------------------	--	---	--	--	--	--

### 70 cm (27.55")

<b>SUN</b> Reference 204 00 070	<b>SOUL</b> Reference 239 00 080	<b>ROND</b> Reference ● BLACK 244 02 070 ● GOLD 244 72 070	<b>VERONA ROND LED</b> Reference 247 00 070	<b>AURA LED</b> Reference 250 02 070	<b>AURA STRAP LED</b> Reference 251 02 070	<b>VERONA LED</b> Reference 246 00 070
---------------------------------------	--	---	---	--	--	--

### 80 cm (31.49")

<b>SUN</b> Reference 204 00 080	<b>SOUL</b> Reference ● BLACK 239 02 090 ● GOLD 239 72 090	<b>ROND</b> Reference ● BLACK 244 02 080 ● GOLD 244 72 080	<b>VERONA ROND LED</b> Reference 247 00 080	<b>AURA LED</b> Reference 250 02 080	<b>COSMOS LED</b> Reference 270 00 080	<b>SPOTY LED</b> Reference 267 00 080
---------------------------------------	---	---	---	--	--	---

### 100 cm (39.37")

<b>SUN</b> Reference 204 00 100	<b>SOUL</b> Reference ● BLACK 239 02 080 ● GOLD 239 72 080	<b>ROND</b> Reference ● BLACK 244 02 100 ● GOLD 244 72 100	<b>VERONA ROND LED</b> Reference 247 00 100	<b>AURA LED</b> Reference 250 02 100	<b>COSMOS LED</b> Reference 270 00 100	<b>SPOTY LED</b> Reference 267 00 100
---------------------------------------	---	---	---	--	--	---

### 120 cm (47.24")

<b>SUN</b> Reference 204 00 120	<b>NITRO</b> Reference 241 00 050	<b>NITRO</b> Reference 241 00 120	<b>VERONA LED</b> Reference 246 00 120	<b>TOWER LED</b> Reference 262 00 120	<b>COSMOS LED</b> Reference 270 00 120	<b>SPOTY LED</b> Reference 267 00 120
---------------------------------------	---	---	--	---	--	---

### 140 cm (55.12")

<b>SUN</b> Reference 204 00 060	<b>NITRO</b> Reference 241 00 140	<b>VERONA LED</b> Reference 246 00 140	<b>TOWER LED</b> Reference 262 00 140
---------------------------------------	---	--	---

<b>ESTHER BLACK 45</b> Reference 400 02 191	<b>AINHOA 74</b> Reference 400 00 152
---	---



# RUSTIK





60 | 80 | 100 | 120

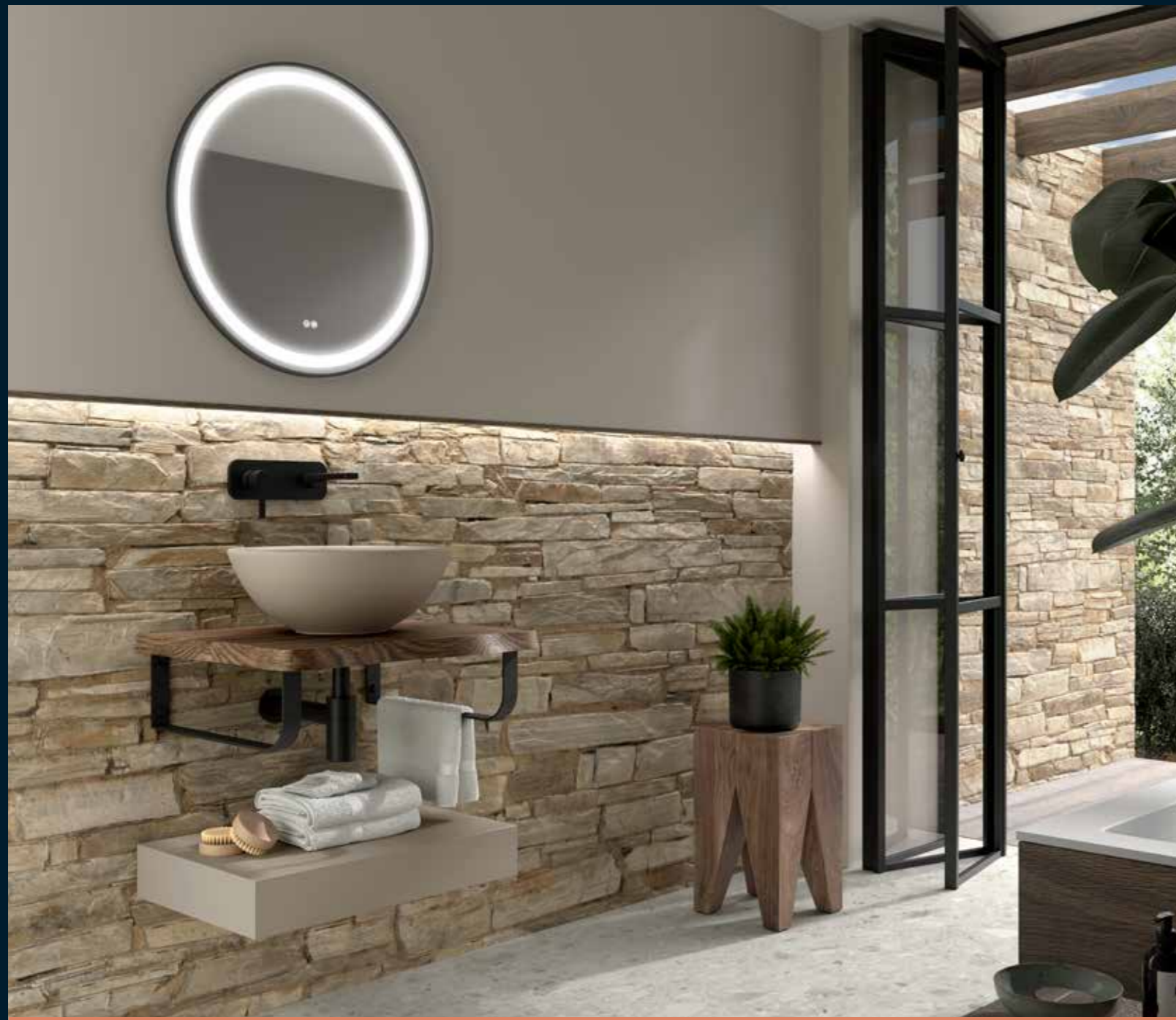

## Rustik Finishes





-  Metal interior drawers. Metallzierleiste. Sistema di estrazione metallico.
-  Total extraction. Vollauszug. Estrazione totale.
-  Soft close. Soft-close-System. Chiusura ammortizzata.
-  GRASS Grass sliding system. Korpuschiene. Grass. Guide Grass.
-  Water resistant. Wasserabweisend. Indrorepellente.



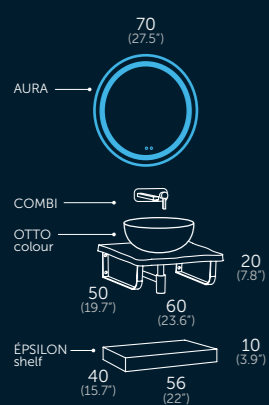
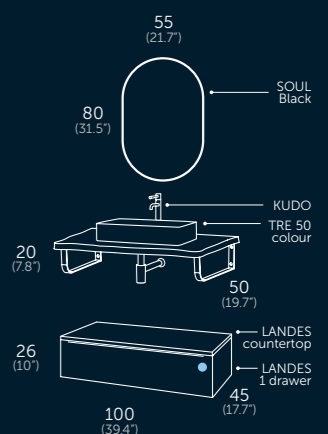

## RUSTIK 100

- 170 89 100 N Rustik 100
- 535 06 035 Tre 50 Colour White
- 410 02 101 Siphon Black / Siphon / Sifone
- 112 35 103 LN Landes Mod. 1d White / Modul 1 Schublade / Modulo 1 Cassetto
- 112 35 210 Landes Countertop White / Abdeckung / Piano
- 239 02 080 Soul Black
- 412 02 815 Kudo Tall Black / Hoch / Alto



## RUSTIK 60

- 170 89 060 N Rustik 60
- 535 19 008 Otto Colour Mink
- 410 02 101 Siphon Black / Siphon / Sifone
- 594 19 061 Epsilon Shelf Mink / Regal / Scaffale
- 250 02 070 Aura
- 412 02 808 Combi Wall-Mounted Black

-  Anti fog system. Anti-Beschlag-System. Sistema antiappannamento.
-  Dual sensor On/Off-anti fog. Doppelter Sensorschalter. On/Off. Doppio sensore di con tatto. On/Off. Antiappannante.

### BRACKETS

- Matte Black
- Matte Chrome

### FURNITURE

- Natural Oak
- Bahia Oak
- Sauvage Oak



Water resistant.  
Wasserabweisend.  
Indirepellente.



Soft close.  
Soft-close-System.  
Chiusura ammortizzata.



Anti fog system.  
Anti-Beschlag-System.  
Sistema antiappannamento.



Ambient light.  
Umgebungslicht.  
Luce ambiente.



Digital clock.  
Digitaluhr.  
Orologio digitale.



Dual sensor On/Off-anti fog.  
Doppelter Sensorschalter. On/Off.  
Doppio sensore touch. On/Off.  
Antiappannante.



Bluetooth music player.  
2 speakers of 3W each.  
Musik Player integriert, Bluetooth  
Anschluss. 2 Lautsprecher je mit 3W.  
Lettore musicale integrato, connessione  
a Bluetooth. 2 altoparlanti 3W ciascuno.

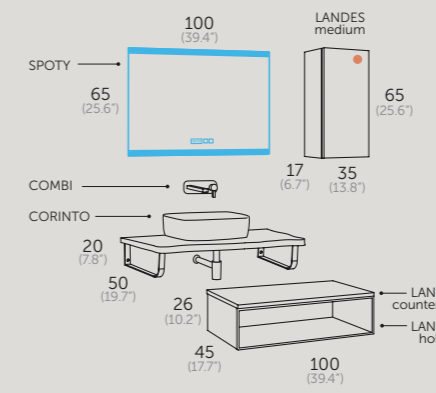

### RUSTIK 100

- 170 24 100 C Rustik 100
- 582 01 037 Corinto
- 410 00 101 Siphon Chrome / Siphon / Sifone
- 112 45 105 Landes Hollow Anthracite / Hohlmodul / Modulo Cavo
- 112 45 210 Landes Countertop Anthracite / Abdeckung / Piano
- 267 00 100 Spoty
- 112 24 435 Landes Medium Natural Oak / Mittel / Medio
- 412 00 808 Combi Wall-Mounted Chrome

#### BRACKETS

- Matte Black
- Matte Chrome

#### FURNITURE

- Sauvage Oak
- Bahia Oak
- Natural Oak

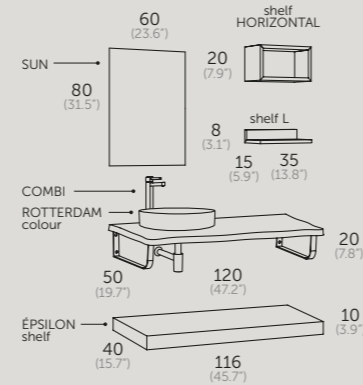

**RUSTIK 120**

- 170 89 120 N Rustik 120
- 535 06 004 Rotterdam Colour White
- 410 02 101 Siphon Black / Siphon / Sifone
- 594 02 121 Epsilon Shelf 120 Black / Regal / Scaffale
- 204 00 060 Sun
- 112 47 520 Shelf L Leaf / Regal L / Scaffale L
- 112 35 505 Shelf Horizontal White / Horizontales Regal / Scaffale Orizzontale
- 412 00 806 Combi Tall Black / Hoch / Alto

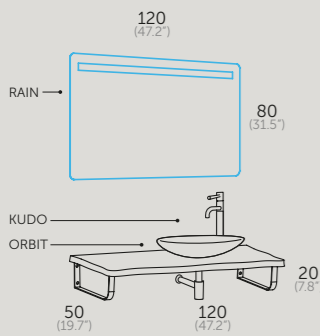

**RUSTIK 120**

- 170 89 120 N Rustik 120
- 518 02 057 Orbit Black
- 410 02 101 Siphon Black / Siphon / Sifone
- 269 00 120 Rain
- 412 02 815 Black Tall Kudo / Hoch / Alto

**BRACKETS**

- Matte Black
- Matte Chrome

**FURNITURE**

- Natural Oak
- Bahia Oak
- Sauvage Oak



Replace the X with the colour reference of the brackets:  
Ersetzen Sie X durch die Farbreferenz der Halterungen.  
Sostituire X con il riferimento del colore delle staffe.

- Chrome (C)
- Black (N)

### RÚSTIK 60 (23.62")

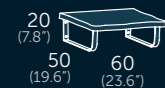

Finishes	Reference
● Natural Oak	170 24 060 (X)
● Bahia Oak	170 96 060 (X)
● Sauvage Oak	170 89 060 (X)

Brackets with leveling system included.  
Halterungen mit Nivelliersystem inbegriffen.  
Staffe con sistema di livellamento incluso.

### RÚSTIK 80 (31.49")



Finishes	Reference
● Natural Oak	170 24 080 (X)
● Bahia Oak	170 96 080 (X)
● Sauvage Oak	170 89 080 (X)

Brackets with leveling system included.  
Halterungen mit Nivelliersystem inbegriffen.  
Staffe con sistema di livellamento incluso.

### RÚSTIK 100 (39.37")



Finishes	Reference
● Natural Oak	170 24 100 (X)
● Bahia Oak	170 96 100 (X)
● Sauvage Oak	170 89 100 (X)

Brackets with leveling system included.  
Halterungen mit Nivelliersystem inbegriffen.  
Staffe con sistema di livellamento incluso.

### RÚSTIK 120 (47.24")



Finishes	Reference
● Natural Oak	170 24 120 (X)
● Bahia Oak	170 96 120 (X)
● Sauvage Oak	170 89 120 (X)

Brackets with leveling system included.  
Halterungen mit Nivelliersystem inbegriffen.  
Staffe con sistema di livellamento incluso.

### FLOW F40



cm	● Natural Oak	● Mink Mate
60	138 24 061	138 74 061
70	138 24 071	138 74 071
80	138 24 081	138 74 081
100	138 24 101	138 74 101
120	138 24 121	138 74 121
140	138 24 141	138 74 141

Invisible brackets with leveling included.  
Verdeckte Befestigung mit Nivellierung inbegriffen.  
Staffe invisibili con livellamento incluso.



**DRILLING SERVICE RUSTIK**  
Plan required.  
Ref: 435 00 050

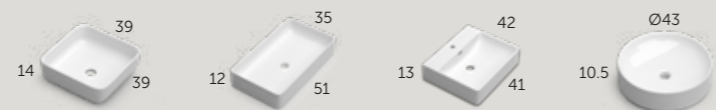

SEI ceramic	TRE 50 ceramic	NOVE 41 ceramic	ROTTERDAM ceramic
Reference ● Glossy White 530 01 006	Reference ● Glossy White 530 01 035 ● Matte Colour 535 XX 035	Reference ● Glossy White 530 01 094	Reference ● Glossy White 507 01 004 ● Matte Colour 535 XX 004



ATENAS/ARUBA	OVAL/ORBIT	CORINTO/BARBADOS	ZAFIRO 50/DARYA 50
Reference ● Solid Surface 580 01 037 ● Resin Colour 581 XX 037	Reference ● Solid Surface 509 01 001 ● Resin Colour 518 XX 057	Reference ● Solid Surface 582 01 037 ● Resin Colour 583 XX 037	Reference ● Solid Surface 531 01 050 ● Resin Colour 548 XX 050



ARUBA resin deco	CURAZAO resin deco	BARBADOS resin deco
Reference ● Carrara 581 76 037 ● Marquina Storm 581 77 037 ● Pure Cement 581 95 037	Reference ● Carrara 585 76 034 ● Marquina Storm 585 77 034 ● Pure Cement 585 95 034	Reference ● Carrara 583 76 037 ● Marquina Storm 583 77 037 ● Pure Cement 583 95 037



COMBI TALL tap	COMBI TALL tap	KUDO TALL tap	KUDO TALL tap	WALL-MOUNTED tap
Reference ● Chrome 412 00 805 ● Black 412 00 806 ● Gold 412 00 807	Reference ● Full Color 412 XX 804	Reference ● Steel 412 04 815 ● Black 412 02 815 ● Brushed Gold 412 03 815	Reference ● Colour 412 XX 816	Reference ● Chrome 412 00 808 ● Black 412 02 808 ● Gold 412 03 808

Replace the XX by the chosen colour code. See codes on page 447. Ersetzen Sie XX durch den Code der ausgewählten Farbe. Siehe Seite 447 für Farbcodes. Sostituire l'XX con il codice colore scelto. Vedere i codici a pagina 447.

### 60 cm (23.62")

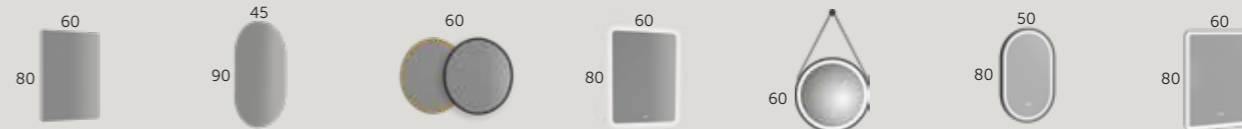

SUN	SOUL	ROND	VERONA LED	AURA STRAP LED	JAZZ LED	ORION / OSIRIS LED
Reference 204 00 060	Reference 239 00 090	Reference ● BLACK 244 02 060 ● GOLD 244 72 060	Reference 246 00 060	Reference 251 02 060	Reference 271 02 050	Reference ● Solid Surface 210 01 060 ● Resin Colour 211 XX 060

### 80 cm (31.49")

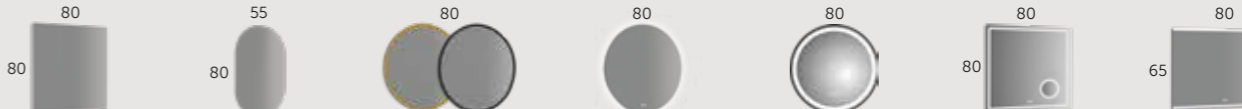

SUN	SOUL	ROND	VERONA ROND LED	AURA LED	COSMOS LED	SPOTY LED
Reference 204 00 080	Reference 239 00 080	Reference ● BLACK 244 02 080 ● GOLD 244 72 080	Reference 247 00 080	Reference 250 02 080	Reference 270 00 080	Reference 267 00 080

### 100 cm (39.37")

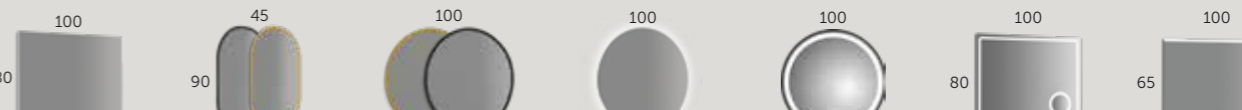

SUN	SOUL	ROND	VERONA ROND LED	AURA LED	COSMOS LED	SPOTY LED
Reference 204 00 100	Reference ● BLACK 239 02 090 ● GOLD 239 72 090	Reference ● BLACK 244 02 100 ● GOLD 244 72 100	Reference 247 00 100	Reference 250 02 100	Reference 270 00 100	Reference 267 00 100

### 120 cm (47.24")

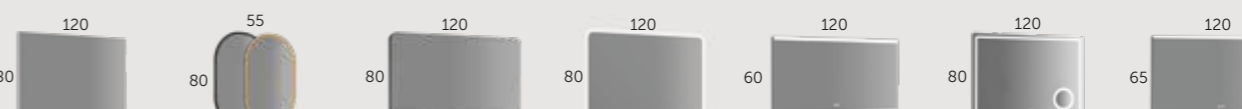

SUN	SOUL	NITRO	VERONA LED	TOWER LED	COSMOS LED	SPOTY LED
Reference 204 00 120	Reference ● BLACK 239 02 080 ● GOLD 239 72 080	Reference 241 00 120	Reference 246 00 120	Reference 262 00 120	Reference 270 00 120	Reference 267 00 120



SIPHON black	DRAIN clic clac	DRAIN clic clac	ADHESIVE 3M towel rail
Reference ● Chrome 410 00 101 ● Black 410 02 101 ● Brushed Gold 410 03 101	Reference ● Chrome 409 00 203 ● Black 410 02 203 ● White 410 01 203 ● Brushed Gold 410 03 203	Reference ● Colour 409 XX 203	Reference ● Chrome 416 00 037 ● Black 416 02 037



NEREA MATTE 30	ESTHER BLACK 45	SOFIA 60
Reference 400 14 141	Reference 400 02 191	Reference 400 00 141



# BAMBOO

60 | 70 | 80 | 100

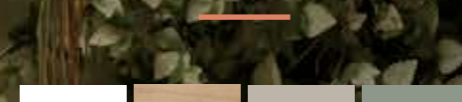

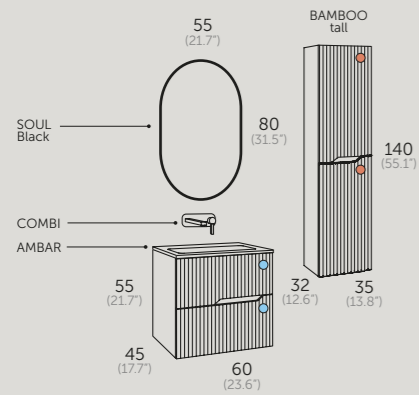

## BAMBOO 60

113 46 060 Bamboo 60  
 506 01 060 G Ambar  
 without tap drilling / Ohne Armaturenloch / senza foro per rubinetto  
 239 02 080 Soul Black  
 113 46 335 Bamboo Tall Mink / Hoch / Alto  
 412 02 808 Combi Wall-Mounted Black



-  Organizer unit.  
Utensilien Behälter.  
Organizzatore.
-  Soft close.  
Soft-close-System.  
Chiusura ammortizzata.
-  Hettich sliding system.  
Korpusschiene Hettich.  
Guide Hettich.
-  Soft close.  
Soft-close-System.  
Chiusura ammortizzata.
-  Matte lacquered finish.  
Matt lackiert.  
Laccato opaco.

Matte White   Natural Oak   Matte Mink   Matte Leaf





## BAMBOO 80

- 113 25 080 Bamboo 80
- 535 02 035 Tre 50 Colour Black
- 542 02 080 Mara Countertop Black / Abdeckung / Piano
- 425 14 080 Reinforcement Bar / Waschtischplatten-Stabilisierung / Barra di rinforzo
- 247 00 080 Verona Rond
- 113 25 335 Bamboo Tall Leaf / Hoch / Alto
- 412 00 807 Combi Tall Gold / Hoch / Alto

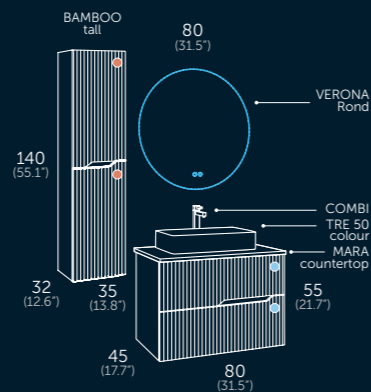

Organizer unit. Utensilien Behälter. Organizzatore.



Soft close. Soft-close-System. Chiusura ammortizzata.



Hettich sliding system. Körperschiene Hettich. Guide Hettich.



Soft close. Soft-close-System. Chiusura ammortizzata.



Matte lacquered finish. Matt lackiert. Laccato opaco.



Anti fog system. Anti-Beschlag-System. Sistema antiappannamento.



Ambient light. Umgebungslicht. Luce ambiente.



Intensity control. Intensitätsregler. Regolatore di intensità.



Dual sensor On/Off-anti fog. Doppelter Sensorschalter. On/Off. Doppio sensore di con tatto. On/Off. Antihappannante.

- Matte White
- Natural Oak
- Matte Mink
- Matte Leaf



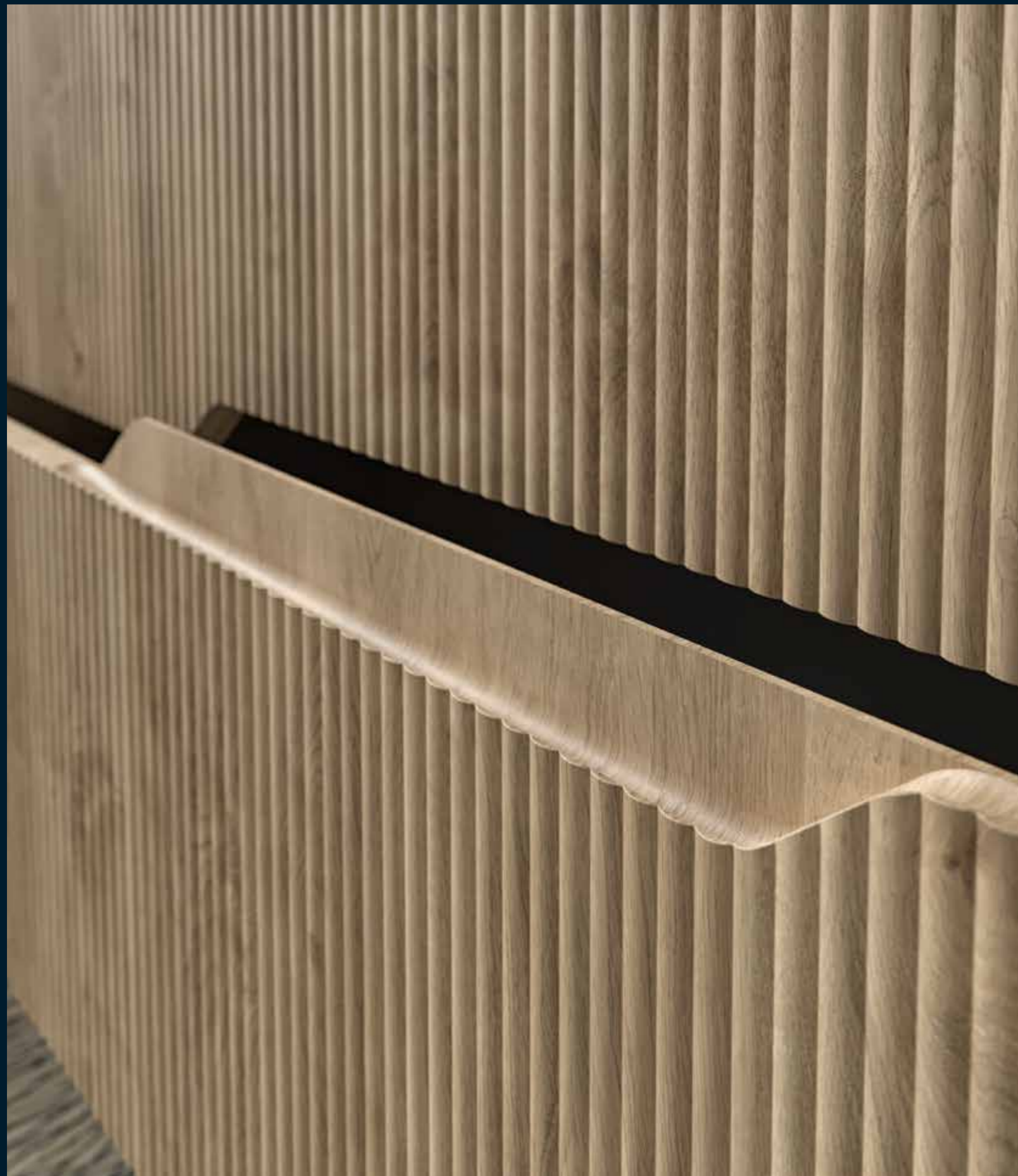

Organizer unit.  
Utensilien Behälter.  
Organizzatore.



Soft close.  
Soft-close-System.  
Chiusura ammorlizzata.



Hettich sliding system.  
Körpuschiene Hettich.  
Guide Hettich.



Anti fog system.  
Anti-Beschlag-System.  
Sistema antiappannamento.



Ambient light.  
Umgebungslicht.  
Luce ambiente.



Intensity control.  
Intensitätsregler.  
Regolatore di intensità.



Dual sensor On/Off-anti fog.  
Doppelter Sensorschalter. On/Off.  
Doppio sensore touch. On/Off.  
Antiappannante.

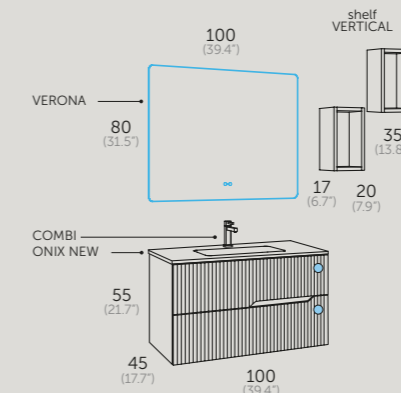

### BAMBOO 100

- 113 24 100 Bamboo 100
- 550 01 100 Onix New
- 246 00 100 Verona
- 112 35 510 Shelf Vertical White / Vertikales Regal / Scaffale Verticale
- 112 24 510 Shelf Vertical Natural Oak / Vertikales Regal / Scaffale Verticale
- 412 00 800 Combi Chrome



- Matte White
- Natural Oak
- Matte Mink
- Matte Leaf

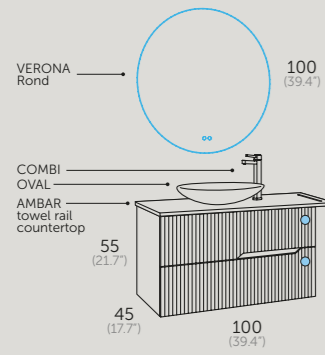

## BAMBOO 100

- 113 27 100 Bamboo 100
- 509 01 001 Oval
- 508 01 100 Ambar Countertop / Abdeckung / Piano  
towel rail increase / Handtuchhalter-Inkrement  
/ incremento del portasciugamani
- 425 14 100 Reinforcement Bar / Waschtischplatten-Stabilisierung / Barra di rinforzo
- 247 00 100 Verona Rond
- 412 06 804 Combi Tall Full Color White



Organizer unit.  
Utensilien Behälter.  
Organizzatore.



Soft close.  
Soft-close-System.  
Chiusura ammortizzata.



Hettich sliding system.  
Korpusschiene Hettich.  
Guide Hettich.



Matte lacquered finish.  
Matt lackiert.  
Laccato opaco.



Anti fog system.  
Anti-Beschlag-System.  
Sistema antiappannamento.



Ambient light.  
Umgebungslicht.  
Luce ambiente.



Intensity control.  
Intensitätsregler.  
Regolatore di intensità.



Dual sensor On/Off-anti fog.  
Z  
Doppio sensore touch. On/Off.  
Antiappannante.

Matte White

Natural Oak

Matte Mink

Matte Leaf



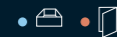

### BAMBOO 60 (23.62")

Finishes Reference

- Matte White 113 27 060
- Natural Oak 113 24 060
- Mink Matte 113 46 060
- Matte Leaf 113 25 060

### BAMBOO 70 (27.55")

Finishes Reference

- Matte White 113 27 070
- Natural Oak 113 24 070
- Matte Mink 113 46 070
- Matte Leaf 113 25 070

### BAMBOO 80 (31.49")

Finishes Reference

- Matte White 113 27 080
- Natural Oak 113 24 080
- Matte Mink 113 46 080
- Matte Leaf 113 25 080

### BAMBOO 100 (39.37")

Finishes Reference

- Matte White 113 27 100
- Natural Oak 113 24 100
- Matte Mink 113 46 100
- Matte Leaf 113 25 100

### BAMBOO TALL

Finishes Reference

- Matte White 113 27 335
- Natural Oak 113 24 335
- Matte Mink 113 46 335
- Matte Leaf 113 25 335

Reversible opening | Umkehrbare Öffnung | Apertura reversibile

**REINFORCEMENT BAR ALUMINIUM**

cm	Reference
60	425 14 060
70	425 14 070
80	425 14 080
100	425 14 100

Its installation is necessary to prevent deformation of the countertop.  
Seine Installation ist notwendig, um Verformungen der Arbeitsplatte zu verhindern.  
La sua installazione è necessaria per prevenire la deformazione del piano di lavoro.

washbasin / Waschbecken / lavabo

ONIX NEW ceramic	AMBAR / MARA	ZEN / IRIS	AMBAR / MARA countertop	MYTHO countertops
Reference ● Glossy White 550 01 060 ● Matte Colour 552 XX 060	Reference ● Solid Surface 506 01 060 ● Resin Colour 540 XX 060	Reference ● Solid Surface 555 01 060 ● Resin Colour 536 XX 060	Reference ● Solid Surface 508 01 060 ● Resin Colour 542 XX 060	Reference ● Carrara 532 76 060 ● Marquina Storm 532 77 060 ● Pure Cement 532 95 060

ONIX NEW ceramic	AMBAR / MARA	ZEN / IRIS	AMBAR / MARA countertop	AMBAR/MARA/plinthed countertop
Reference ● Glossy White 550 01 070 ● Matte Colour 552 XX 070	Reference ● Solid Surface 506 01 070 ● Resin Colour 540 XX 070	Reference ● Solid Surface 555 01 070 ● Resin Colour 536 XX 070	Reference ● Solid Surface 508 01 070 ● Resin Colour 542 XX 070	Reference ● Solid Surface 525 01 070 ● Resin Colour 541 XX 070

ONIX NEW ceramic	AMBAR / MARA	ZEN / IRIS	AMBAR / MARA countertop	MYTHO countertops
Reference ● Glossy White 550 01 080 ● Matte Colour 552 XX 080	Reference ● Solid Surface 506 01 080 ● Resin Colour 540 XX 080	Reference ● Solid Surface 555 01 080 ● Resin Colour 536 XX 080	Reference ● Solid Surface 508 01 080 ● Resin Colour 542 XX 080	Reference ● Carrara 532 76 080 ● Marquina Storm 532 77 080 ● Pure Cement 532 95 080

ONIX NEW ceramic	AMBAR / MARA	ZEN / IRIS	AMBAR / MARA countertop	MYTHO countertops
Reference ● Glossy White 550 01 100	Reference ● Solid Surface 506 01 100 ● Resin Colour 540 XX 100	Reference ● Solid Surface 555 01 100 ● Resin Colour 536 XX 100	Reference ● Solid Surface 508 01 100 ● Resin Colour 542 XX 100	Reference ● Carrara 532 76 100 ● Marquina Storm 532 77 100 ● Pure Cement 532 95 100

countertop washbasins / Aufsatzwaschbecken / lavabi da appoggio

ESTAMBUL ceramic	ROTTERDAM ceramic	CORINTO/BARBADOS	OVAL/ORBIT	ARUBA resin deco
Reference ● Glossy White 507 01 005	Reference ● Solid Surface 507 01 004 ● Matte Colour 535 XX 004	Reference ● Solid Surface 582 01 037 ● Resin Colour 583 XX 037	Reference ● Solid Surface 509 01 001 ● Resin Colour 518 XX 057	Reference ● Carrara 581 76 037 ● Marquina Storm 581 77 037 ● Pure Cement 581 95 037

**DRILLING SERVICE**  
Plan required.  
Ref: 435 00 050

Replace the XX by the chosen colour code. See codes on page 447.  
Ersetzen Sie XX durch den Code der ausgewählten Farbe. Siehe Seite 447 für Farbcodes.  
Sostituire l'XX con il codice colore scelto. Vedere i codici a pagina 447.

mirrors / Spiegel / specchi

MORE OPTIONS SEE PAGES 327-434

SUN	SOUL	ROND	RAIN LED	VERONA LED	JAZZ LED	AURA STRAP LED	ORION / OSIRIS LED
Reference 204 00 060	Reference 239 00 090	Reference ● BLACK 244 02 060 ● GOLD 244 72 060	Reference 269 00 060	Reference 246 00 060	Reference 271 02 050	Reference 251 02 060	Reference ● Solid Surface 210 01 060 ● Resin Colour 211 XX 060

SUN	SOUL	ROND	RAIN LED	VERONA LED	VERONA ROND LED	AURA LED	AURA STRAP LED
Reference 204 00 070	Reference 239 00 080	Reference ● BLACK 244 02 070 ● GOLD 244 72 070	Reference 269 00 070	Reference 246 00 070	Reference 247 00 070	Reference 250 02 070	Reference 251 02 070

SUN	SOUL	ROND	RAIN LED	VERONA LED	VERONA ROND LED	AURA LED	ORION / OSIRIS LED
Reference 204 00 080	Reference ● BLACK 239 02 090 ● GOLD 239 72 090	Reference ● BLACK 244 02 080 ● GOLD 244 72 080	Reference 269 00 080	Reference 246 00 080	Reference 247 00 080	Reference 250 02 080	Reference ● Solid Surface 210 01 080 ● Resin Colour 211 XX 080

SUN	SOUL	ROND	RAIN LED	VERONA LED	VERONA ROND LED	AURA LED	ORION / OSIRIS LED
Reference 204 00 100	Reference ● BLACK 239 02 080 ● GOLD 239 72 080	Reference ● BLACK 244 02 100 ● GOLD 244 72 100	Reference 269 00 100	Reference 246 00 100	Reference 247 00 100	Reference 250 02 100	Reference ● Solid Surface 210 01 100 ● Resin Colour 211 XX 100

accessories / Zubehör / complementi

COMBI tap	KUDO TALL tap	WALL-MOUNTED tap	DRAIN clic clac	LUX 38 towel rail	FLAT IRON support	SIPHON cutout lid	ESTHER BLACK 45
Reference ● Chrome 412 00 800 ● Black 412 00 801 ● Gold 412 00 802 ● Full Color 412 XX 803	Reference ● Steel 412 04 815 ● Black 412 02 815 ● Brushed Gold 412 03 815 ● Full Color 412 XX 816	Reference ● Chrome 412 00 808 ● Black 412 02 808 ● Gold 412 03 808	Reference ● Black 410 02 203 ● White 410 01 203 ● Brushed Gold 410 03 203 ● Colour 409 XX 203	Reference ● Chrome 417 00 038 ● Black 417 02 038 ● White 417 27 038	Reference ● Black 419 02 002 ● Chrome 419 00 002	Reference 418 91 000	Reference 400 02 191



# OSLO

70 | 80 | 100 | 120





-  Organizer unit.  
Utensilien Behälter.  
Organizatore.
-  Adjustable front.  
Einstellbare Vorderseite.  
Frontali regolabili.
-  Soft close.  
Soft-close-System.  
Chiusura ammortizzata.
-  Hettich sliding system.  
Korpusschiene Hettich.  
Guide Hettich.
-  Soft close.  
Soft-close-System.  
Chiusura ammortizzata.
-  Anti fog system.  
Anti-Beschlag-System.  
Sistema antiappannamento.
-  Ambient light.  
Umgebungslicht.  
Luce ambiente.
-  Intensity control.  
Intensitätsregler.  
Regolatore di intensità.
-  Dual sensor On/Off-anti fog.  
Doppelter Sensorschalter. On/Off.  
Doppio sensore touch. On/Off.  
Antiappannante.

## OSLO 80

- 142 24 080 Oslo 80
- 540 23 080 Mara Island
- 247 00 080 Verona Rond
- 112 24 435 Landes Medium Natural Oak / Mittel / Medio
- 112 49 520 Shelf L Island / Regal L / Scaffale L
- 412 03 810 Kudo Brushed Gold / Gebürstet / Spazzolato

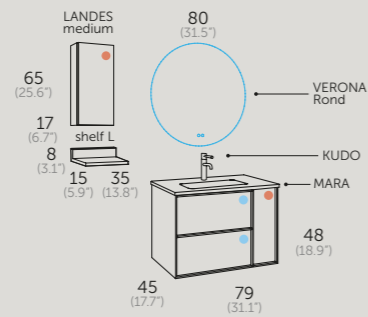
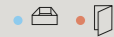

- Matte White
- Natural Oak
- Walnut Vera
- Matte Mink
- Matte Mist



-  Organizer unit. Utensilien Behälter. Organizzatore.
-  Adjustable front. Einstellbare Vorderseite. Frontali regolabili.
-  Soft close. Soft-close-System. Chiusura ammortizzata.
-  Hettich sliding system. Körperschiene Hettich. Guide Hettich.
-  Soft close. Soft-close-System. Chiusura ammortizzata.
-  Matte lacquered finish. Matt lackiert. Laccato opaco.
-  Anti fog system. Anti-Beschlag-System. Sistema antiappannamento.
-  Ambient light. Umgebungslicht. Luce ambiente.
-  Intensity control. Intensitätsregler. Regolatore di intensità.
-  Dual sensor On/Off-anti fog. Doppelter Sensorschalter. On/Off. Doppio sensore di con tatto. On/Off. Antiappannante.

## OSLO 80

- 142 75 080 Oslo 80
- 550 01 080 Onix New
- 246 00 080 Verona
- 412 00 801 Combi Black

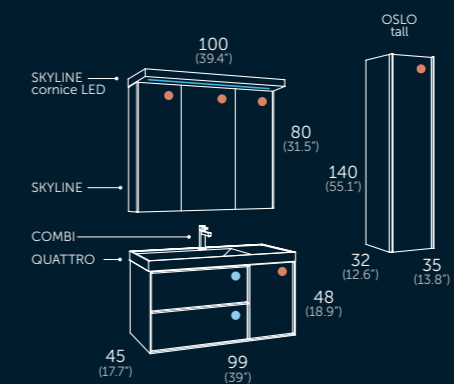
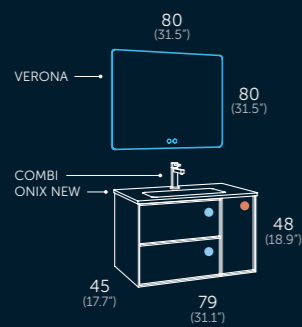
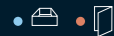

## OSLO 100

- 142 46 100 Oslo 100
- 522 01 100 Quattro
- 341 46 101 Skyline Mink
- 341 46 101 Cornice LED Mink / LED-Gesims / Cornice LED
- 142 46 335 Oslo Tall Mink / Hoch / Alto
- 412 00 800 Combi Chrome

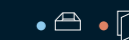

- Matte White
- Natural Oak
- Walnut Vera
- Matte Mink
- Matte Mist

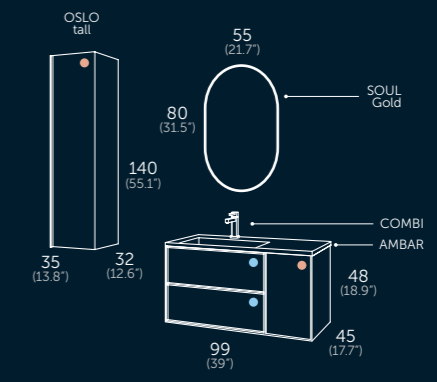

## OSLO 100

- 142 84 100 Oslo 100
- 432 00 002 Special Drawer Offset Siphon Saver / Spezieller Schublade Versetzter Siphonausschnitt / Cassetto Speciale Salvafisone Decentrato
- 506 01 107 Ambar (70 + 30) Left / Links / Sinistra
- 239 72 080 Soul Gold
- 142 84 335 Oslo Tall Walnut Vera / Hoch / Alto
- 412 00 802 Combi Gold

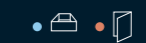

Organizer unit. Utensilien Behälter. Organizzatore.



Adjustable front. Einstellbare Vorderseite. Frontali regolabili.



Soft close. Soft-close-System. Chiusura ammortizzata.



Hettich sliding system. Körperschiene Hettich. Guide Hettich.



Soft close. Soft-close-System. Chiusura ammortizzata.

- Matte White
- Natural Oak
- Walnut Vera
- Matte Mink
- Matte Mist

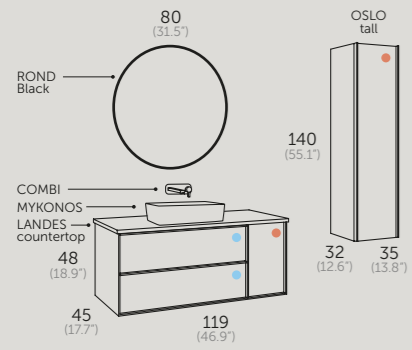

## OSLO 120

- 142 27 120 Oslo 120
- 584 01 034 Mykonos
- 112 24 212 Landes Countertop Natural Oak / Abdeckung / Piano
- 425 14 120 Reinforcement Bar / Waschtischplatten-Stabilisierung / Barra di rinforzo
- 244 02 080 Rond Black
- 142 27 335 Oslo Tall White / Hoch / Alto
- 412 02 808 Combi Wall-Mounted Black



-  Organizer unit.  
Utensilien Behälter.  
Organizatore.
-  Adjustable front.  
Einstellbare Vorderseite.  
Frontali regolabili.
-  Soft close.  
Soft-close-System.  
Chiusura ammortizzata.
-  Hettich sliding system.  
Korpusschiene Hettich.  
Guide Hettich.
-  Soft close.  
Soft-close-System.  
Chiusura ammortizzata.
-  Matte lacquered finish.  
Matt lackiert.  
Laccato opaco.

- Matte White
- Natural Oak
- Walnut Vera
- Matte Mink
- Matte Mist



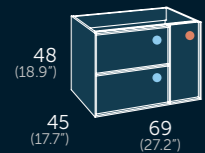

### OSLO 70 (27.55")

Finishes	Reference
● Matte White	142 27 070
● Natural Oak	142 24 070
● Walnut Vera	142 84 070
● Matte Mink	142 46 070
● Matte Mist	142 75 070

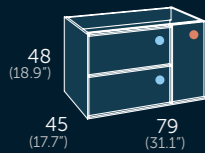

### OSLO 80 (31.49")

Finishes	Reference
● Matte White	142 27 080
● Natural Oak	142 24 080
● Walnut Vera	142 84 080
● Matte Mink	142 46 080
● Matte Mist	142 75 080

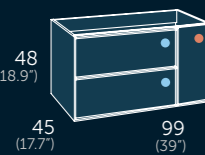

### OSLO 100 (39.37")

Finishes	Reference
● Matte White	142 27 100
● Natural Oak	142 24 100
● Walnut Vera	142 84 100
● Matte Mink	142 46 100
● Matte Mist	142 75 100

#### 1 CENTRED BASIN 1 ZENTRIERTES BECKEN 1 VASCA CENTRATA

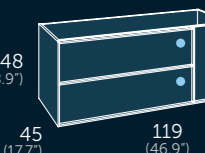

### OSLO 120 (47.24")

Finishes	Reference
● Matte White	142 27 120
● Natural Oak	142 24 120
● Walnut Vera	142 84 120
● Matte Mink	142 46 120
● Matte Mist	142 75 120

### LANDES COUNTERTOP



Reinforcement Bar not included.  
Verstärkungsstange nicht inbegriffen.  
Barra di rinforzo non inclusa.

#### REINFORCEMENT BAR ALUMINIUM

70	425 14 070
80	425 14 080
100	425 14 100
120	425 14 120

Its installation is necessary to prevent deformation of the countertop.  
Seine Installation ist notwendig, um Verformungen der Arbeitsplatte zu verhindern.  
La sua installazione è necessaria per prevenire la deformazione del piano di lavoro.

### washbasin / Waschbecken / lavabo



ONIX NEW ceramic	AMBAR / MARA	ZEN / IRIS	AMBAR / MARA plinthead	AMBAR / MARA countertop
Reference ● Glossy White 550 01 070 ● Matte Colour 552 XX 070	Reference ● Solid Surface 506 01 070 ● Resin Colour 540 XX 070	Reference ● Solid Surface 555 01 070 ● Resin Colour 536 XX 070	Reference ● Solid Surface 524 01 070 ● Resin Colour 541 XX 070	Reference ● Solid Surface 508 01 070 ● Resin Colour 542 XX 070



ONIX NEW ceramic	AMBAR / MARA	ZEN / IRIS	QUATTRO ceramic	AMBAR / MARA countertop
Reference ● Glossy White 550 01 080 ● Matte Colour 552 XX 080	Reference ● Solid Surface 506 01 080 ● Resin Colour 540 XX 080	Reference ● Solid Surface 555 01 080 ● Resin Colour 536 XX 080	Reference ● Glossy White 522 01 080	Reference ● Solid Surface 508 01 080 ● Resin Colour 542 XX 080



ONIX NEW ceramic	AMBAR / MARA	ZEN / IRIS	QUATTRO ceramic	AMBAR / MARA countertop
Reference ● Glossy White 550 01 100	Reference ● Solid Surface 506 01 100 ● Resin Colour 540 XX 100	Reference ● Solid Surface 555 01 100 ● Resin Colour 536 XX 100	Reference ● Glossy White 522 01 100	Reference ● Solid Surface 508 01 100 ● Resin Colour 542 XX 100



ONIX NEW ceramic	AMBAR / MARA	ZEN / IRIS	AMBAR / MARA plinthead	AMBAR / MARA countertop
Reference ● Glossy White 550 01 120	Reference ● Solid Surface 506 01 120 ● Resin Colour 540 XX 120	Reference ● Solid Surface 555 01 120 ● Resin Colour 536 XX 120	Reference ● Solid Surface 524 01 120 ● Resin Colour 541 XX 120	Reference ● Solid Surface 508 01 120 ● Resin Colour 542 XX 120

### countertop washbasins / Aufsatzwaschbecken / lavabi da appoggio



ROTTERDAM ceramic	ESTAMBUL ceramic	MYKONOS/CURAZAO	OVAL / ORBIT	BARBADOS resin deco
Reference ● Glossy White 507 01 004 ● Matte Colour 535 XX 004	Reference ● Glossy White 507 01 005	Reference ● Solid Surface 584 01 034 ● Resin Colour 585 XX 034	Reference ● Solid Surface 509 01 001 ● Resin Colour 518 XX 057	Reference ● Carrara 583 76 037 ● Marquina Storm 583 77 037 ● Pure Cement 583 95 037

Replace the XX by the chosen colour code. See codes on page 447.  
Ersetzen Sie XX durch den Code der ausgewählten Farbe. Siehe Seite 447 für Farbcodes.  
Sostituire l'XX con il codice colore scelto. Vedere i codici a pagina 447.



#### DRILLING SERVICE

Plan required.  
Ref: 435 00 050

### mirrors / Spiegel / specchi



NITRO	ROND	RAIN LED	VERONA ROND LED	AURA LED	VERONA LED	STONE LED	FLASH 70 cabinet
Reference 241 00 070	Reference ● BLACK 244 02 070 ● GOLD 244 72 070	Reference 269 00 070	Reference 247 00 070	Reference 250 02 070	Reference 246 00 070	Reference 261 00 080	Reference ● Steel 340 11 070 2 Doors



NITRO	ROND	RAIN LED	VERONA ROND LED	AURA LED	VERONA LED	COSMOS LED	SKYLINE 80 cabinet
Reference 241 00 080	Reference ● BLACK 244 02 080 ● GOLD 244 72 080	Reference 269 00 080	Reference 247 00 080	Reference 250 02 080	Reference 246 00 080	Reference 270 00 080	Reference ● Matte White 341 35 080 ● Natural Oak 341 24 080 More colours on page: 422 2 Doors



NITRO	ROND	RAIN LED	VERONA ROND LED	AURA LED	VERONA LED	COSMOS LED	SKYLINE 100 cabinet
Reference 241 00 100	Reference ● BLACK 244 02 100 ● GOLD 244 72 100	Reference 269 00 100	Reference 247 00 100	Reference 250 02 100	Reference 246 00 100	Reference 270 00 100	Reference ● Matte White 341 35 100 ● Natural Oak 341 24 100 More colours on page: 422 3 Doors



NITRO	RAIN LED	COSMOS LED	SKYLINE 120 cabinet
Reference 241 00 120	Reference 269 00 120	Reference 270 00 120	Reference ● Matte White 341 35 120 ● Natural Oak 341 24 120 More colours on page: 422 3 Doors

### accessories / Zubehör / complementi



KUDO tap	COMBI ALTO tap	DRAIN clic clac	ESTHER BLACK 45
Reference ● Brushed Steel 412 04 810 ● Black 412 02 810 ● Brushed Gold 412 03 810 ● Full Color 412 XX 811	Reference ● Chrome 583 76 037 ● Black 412 00 806 ● Gold 412 00 807 ● Full Color 412 XX 804	Reference ● Chrome 410 00 203 ● Black 410 02 203 ● White 410 01 203 ● Brushed Gold 410 03 203 ● Colour 409 XX 203	Reference 400 02 191

### SPECIAL DRAWER SPEZIALSCHUBLADE / CASSETTO SPECIALE

Check all the information on page 429.  
Konsultieren Sie alle Informationen auf Seite 429.  
Consulta tutte le informazioni nella pagina 429.



#### OFFSET SIPHON CUTOUT VERSCHIEBBARER SIPHON / SIFONE REGOLABILE

Ref: 432 00 002  
A plan is required. Only offset to the left. Not available for the 70 cm size.  
Ein Plan ist erforderlich. Nur nach links versetzbar. Nicht verfügbar für die Größe 70 cm. È necessario un piano. Solo spostabile a sinistra. Non disponibile per la misura di 70 cm.



#### WITHOUT SIPHON CUTOUT OHNE SIPHON / SENZA SIFONE

Ref: 432 00 000

### side cabinet / Hängeschränke / armadi

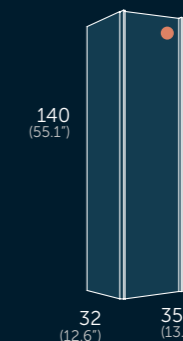

### OSLO TALL

Finishes	Reference
● Matte White	142 27 335
● Natural Oak	142 24 335
● Walnut Vera	142 84 335
● Matte Mink	142 46 335
● Matte Mist	142 75 335

Reversible opening | Umkehrbare Öffnung | Apertura reversibile



# PRAGA

60 | 70 | 80 | 100 | 120

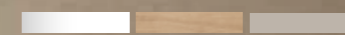

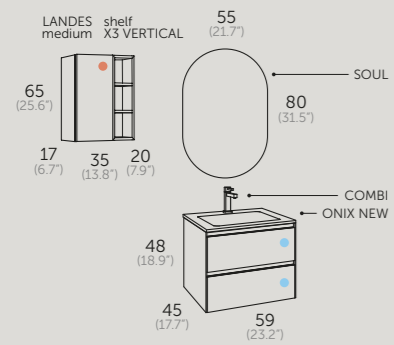





## PRAGA 60

- 162 24 060 Praga 60
- 550 01 060 Onix New
- 239 00 080 Soul
- 112 24 435 Landes Medium Natural Oak / Mittel / Medio
- 112 47 500 Shelf X3 Vertical Leaf / Regal X3 Vertikal / Scaffale X3 Verticale
- 412 24 800 Combi Chrome - Natural Oak









-  Organizer unit.  
Utensilien Behälter.  
Organizzatori.
-  Adjustable front.  
Einstellbare Vorderseite.  
Frontali regolabili.
-  Soft close.  
Soft-close-System.  
Chiusura ammortizzata.
-  Hettich sliding system.  
Korpusschiene Hettich.  
Guide Hettich.
-  Push to open.  
Push-to-open-System.  
Sistema Push.

Glossy White

Natural Oak

Matte Mink



-  Organizer unit. Utensilien Behälter. Organizzatore.
-  Adjustable front. Einstellbare Vorderseite. Frontali regolabili.
-  Soft close. Soft-close-System. Chiusura ammortizzata.
-  Hettich sliding system. Korpusschiene Hettich. Guide Hettich.
-  Soft close. Soft-close-System. Chiusura ammortizzata.
-  Matte lacquered finish. Matt lackiert. Laccato opaco.

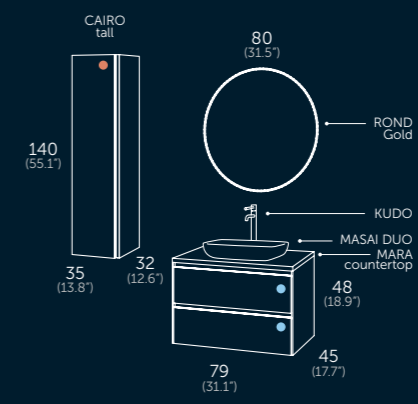

**PRAGA 80**

162 46 080	Praga 80
523 19 051	Masai Duo Mink
542 06 080	Mara Countertop White / Abdeckung / Piano
425 14 080	Reinforcement Bar / Waschtischplatten-Stabilisierung / Barra di rinforzo
244 72 080	Rond Gold
194 46 335	Cairo Tall Mink / Hoch / Alto
412 03 815	Kudo Tall Brushed Gold / Gebürstet / Spazzolato

Glossy White | Natural Oak | Matte Mink

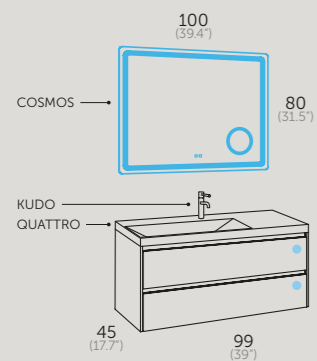

### PRAGA 100

- 162 01 100 Praga 100
- 522 01 100 Quattro
- 270 00 100 Cosmos
- 412 04 810 Kudo Brushed Steel / Gebürstet / Spazzolato



Glossy White   Natural Oak   Matte Mink



Organizer unit.  
Utensilien Behälter.  
Organizzatore.



Adjustable front.  
Einstelbare Vorderseite.  
Frontali regolabili.



Soft close.  
Soft-close-System.  
Chiusura ammortizzata.



Hettich sliding system.  
Korpusschiene Hettich.  
Guide Hettich.



Glossy lacquered finish.  
Glänzend lackiert.  
Laccato lucido.



Anti fog system.  
Anti-Beschlag-System.  
Sistema antiappannamento.



Ambient light.  
Umgebungslicht.  
Luce ambiente.



Intensity control.  
Intensitätsregler.  
Regolatore di intensità.



Magnifying zoom in Mirror.  
Lupe 3x Vergrößerung.  
Lente d'ingrandimento 3x.



Dual sensor On/Off-anti fog.  
Doppelter Sensorschalter. On/Off.  
Doppio sensore touch. On/Off.  
Antiappannante.

### PRAGA 120 2 SINKS

- 162 24 120 Praga 120
- 506 01 122 Ambar 2s.
- 246 00 120 Verona
- 412 00 801 Combi Black

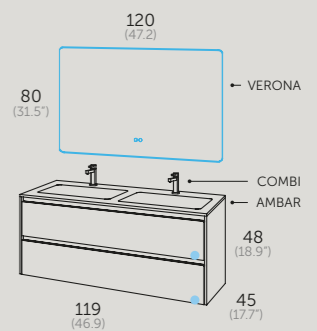

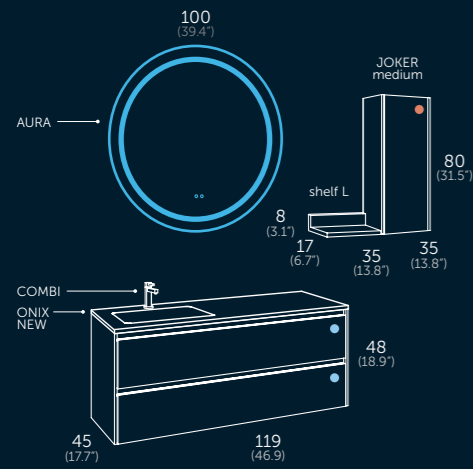

## PRAGA 120 2 SINKS

162	46	120	Praga 120 2s
550	01	121	Onix New 120 (60+60) Left / Links / Sinistra
250	02	100	Aura
137	74	435	Joker Medium Mink / Mittel / Medio
112	35	520	Shelf L White / Regal L / Scaffale L
412	00	801	Combi Black



Organizer unit. Utensilien Behälter.  
Organizzatore.



Adjustable front. Einstellbare  
Vorderseite. Frontali regolabili.



Soft close. Soft-close-System.  
Chiusura ammortizzata.



Hettich sliding system. Korpussschiene  
Hettich. Guide Hettich.



Soft close. Soft-close-System.  
Chiusura ammortizzata.



Matte lacquered finish. Matt lackiert.  
Laccato opaco.



Anti fog system. Anti-Beschlag-System.  
Sistema antiappannamento.



Dual sensor On/Off-anti fog. Doppelter  
Sensorschalter. On/Off. Doppio sensore  
di con tatto. On/Off. Antiappannante.

Glossy White

Natural Oak

Matte Mink



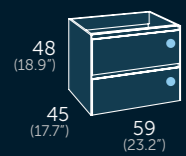
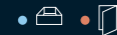

**PRAGA 60** (23.62")

Finishes	Reference
Glossy White	162 01 060
Natural Oak	162 24 060
Matte Mink	162 46 060

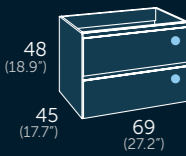

**PRAGA 70** (27.55")

Finishes	Reference
Glossy White	162 01 070
Natural Oak	162 24 070
Matte Mink	162 46 070

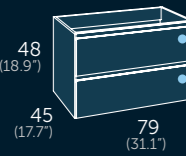

**PRAGA 80** (31.49")

Finishes	Reference
Glossy White	162 01 080
Natural Oak	162 24 080
Matte Mink	162 46 080

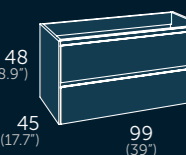

**PRAGA 100** (39.37")

Finishes	Reference
Glossy White	162 01 100
Natural Oak	162 24 100
Mink Matte	162 46 100

1 CENTRED BASIN  
1 ZENTRIERTES BECKEN  
1 VASCA CENTRATA

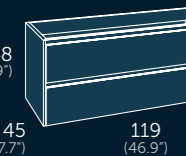

**PRAGA 120** (47.24")

Finishes	Reference
Glossy White	162 01 121
Natural Oak	162 24 121
Matte Mink	162 46 121

2 BASINS  
2 BECKEN  
2 VASCHE

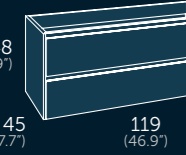

**PRAGA 120** (47.24")

Finishes	Reference
Glossy White	162 01 120
Natural Oak	162 24 120
Matte Mink	162 46 120

Siphon hole tray included.  
Ablage mit Siphonausschnitt inbegriffen.  
Vassoio con foro per sifone incluso.



ONIX NEW ceramic	AMBAR / MARA	ZEN / IRIS	QUATTRO ceramic	AMBAR / MARA countertop
Reference Glossy White 550 01 060 Matte Colour 552 XX 060	Reference Solid Surface 506 01 060 Resin Colour 540 XX 060	Reference Solid Surface 555 01 060 Resin Colour 536 XX 060	Reference Glossy White 522 01 060	Reference Solid Surface 508 01 060 Resin Colour 542 XX 060



ONIX NEW ceramic	AMBAR / MARA	ZEN / IRIS	AMBAR / MARA plinthed	AMBAR / MARA countertop
Reference Glossy White 550 01 070 Matte Colour 552 XX 070	Reference Solid Surface 506 01 070 Resin Colour 540 XX 070	Reference Solid Surface 555 01 070 Resin Colour 536 XX 070	Reference Solid Surface 524 01 070 Resin Colour 541 XX 070	Reference Solid Surface 508 01 070 Resin Colour 542 XX 070



ONIX NEW ceramic	AMBAR / MARA	ZEN / IRIS	QUATTRO ceramic	AMBAR / MARA countertop
Reference Glossy White 550 01 080 Matte Colour 552 XX 080	Reference Solid Surface 506 01 080 Resin Colour 540 XX 080	Reference Solid Surface 555 01 080 Resin Colour 536 XX 080	Reference Glossy White 522 01 080	Reference Solid Surface 508 01 080 Resin Colour 542 XX 080



ONIX NEW ceramic	AMBAR / MARA	ZEN / IRIS	QUATTRO ceramic	AMBAR / MARA countertop
Reference Glossy White 550 01 100	Reference Solid Surface 506 01 100 Resin Colour 540 XX 100	Reference Solid Surface 555 01 100 Resin Colour 536 XX 100	Reference Glossy White 522 01 100	Reference Solid Surface 508 01 100 Resin Colour 542 XX 100



ONIX NEW ceramic	AMBAR / MARA	ZEN / IRIS	AMBAR / MARA plinthed	AMBAR / MARA countertop
Reference Glossy White 550 01 120	Reference Solid Surface 506 01 120 Resin Colour 540 XX 120	Reference Solid Surface 555 01 120 Resin Colour 536 XX 120	Reference Solid Surface 524 01 120 Resin Colour 541 XX 120	Reference Solid Surface 508 01 120 Resin Colour 542 XX 120



ONIX NEW ceramic	AMBAR / MARA	ZEN / IRIS	ONIX NEW ceramic	AMBAR / MARA
Reference Glossy White 550 01 122	Reference Solid Surface 506 01 122 Resin Colour 540 XX 122	Reference Solid Surface 555 01 122 Resin Colour 536 XX 122	Reference Glossy White 550 01 121	Reference Solid Surface 506 01 123 Resin Colour 540 XX 123

Replace the **XX** by the chosen colour code. See codes on page 447. Ersetzen Sie **XX** durch den Code der ausgewählten Farbe. Siehe Seite 447 für Farbcodes. Sostituire l'**XX** con il codice colore scelto. Vedere i codici a pagina 447.



SUN	SOUL	RAIN LED	VERONA LED	JAZZ LED
Reference 204 00 060	Reference BLACK 239 02 090 GOLD 239 72 090	Reference 269 00 060	Reference 246 00 060	Reference 271 02 050

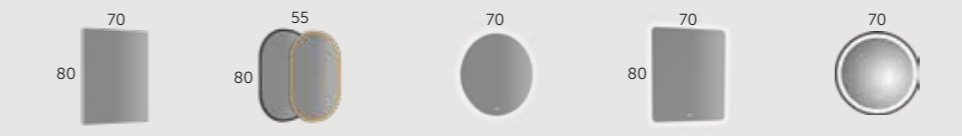

SUN	SOUL	VERONA ROND LED	VERONA LED	AURA LED
Reference 204 00 070	Reference BLACK 239 02 080 GOLD 239 72 080	Reference 247 00 070	Reference 246 00 070	Reference 250 02 070

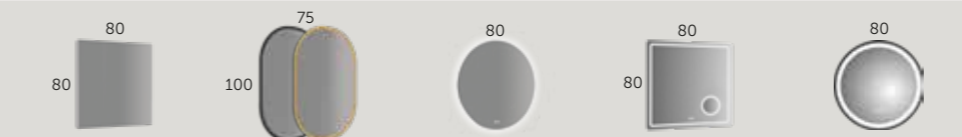

SUN	SOUL	VERONA ROND LED	COSMOS LED	AURA LED
Reference 204 00 080	Reference BLACK 239 02 100 GOLD 239 72 100	Reference 247 00 080	Reference 270 00 080	Reference 250 02 080

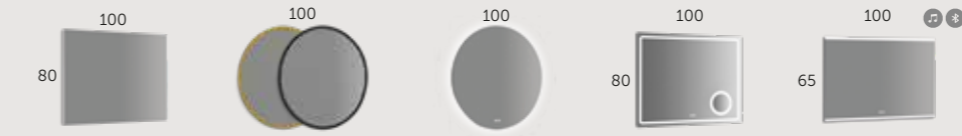

SUN	ROND	VERONA ROND LED	COSMOS LED	SPOTY LED
Reference 204 00 100	Reference BLACK 244 02 100 GOLD 244 72 100	Reference 247 00 100	Reference 270 00 100	Reference 267 00 100



SUN	NITRO	RAIN LED	COSMOS LED	SPOTY LED
Reference 204 00 120	Reference 241 00 120	Reference 269 00 120	Reference 270 00 120	Reference 267 00 120



SOUL	SKYLINE 120 cabinet
Reference 239 00 090	Reference Matte White 341 35 120 Natural Oak 341 24 120 More colours on page: 422 3 Doors



COMBI tap	LUX 38 towel rail
Reference Chrome 412 00 800 Black 412 00 801 Gold 412 00 802	Reference Chrome 417 00 038 Black 417 02 038 White 417 27 038

**CAIRO TALL**

Finishes	Reference
Glossy White	194 01 335
Natural Oak	194 24 335
Matte Mink	194 46 335

**JOKER MEDIUM**

Finishes	Reference
Glossy White	137 01 435
Natural Oak	137 24 435
Matte Mink	137 74 435

**JOKER SMALL**

Finishes	Reference
Glossy White	137 01 445
Natural Oak	137 24 445
Matte Mink	137 74 445

**LANDES COUNTERTOP**

cm	Natural Oak
60	112 24 206
70	112 24 207
80	112 24 208
100	112 24 210
120	112 24 212

REINFORCEMENT BAR ALUMINIUM

cm	Reference
60	425 14 060
70	425 14 070
80	425 14 080
100	425 14 100
120	425 14 120

To avoid deformation of the lids, it is necessary to install the reinforcement bar in the module where the basin will be supported. Um eine Verformung des Waschtischplatten zu vermeiden, ist es notwendig eine Waschtischplatten-Stabilisierung in dem Modul zu installieren, auf dem das Waschbecken aufliegt. Per evitare la deformazione del piano, è necessario installare la barra di rinforzo nel modulo dove il lavabo sarà sostenuto.

countertop washbasins



OTTO ceramic	MYKONOS/CURAZAO	ARUBA resin deco
Reference Glossy White 530 01 008 Matte Colour 535 XX 008	Reference Solid Surface 584 01 034 Resin Colour 585 XX 034	Reference Carrara 581 76 037 Marquina Storm 581 77 037 Pure cement 581 95 037

**SPECIAL DRAWER**

SPEZIALSCHUBLADE / CASSETTO SPECIALE

Check all the information on page 429. Konsultieren Sie alle Informationen auf Seite 429. Consulta tutte le informazioni nella pagina 429.

OFFSET SIPHON CUTOUT  
VERSCHIEBBARER SIPHON / SIFONE REGOLABILE  
Ref: 432 00 002

A plan is required. Not available for the 60 cm and 120 cm sizes. Ein Plan ist erforderlich. Nicht verfügbar für die Größen 60 cm und 120 cm. È necessario un piano. Non disponibile per le misure di 60 cm e 120 cm.

WITHOUT SIPHON CUTOUT  
OHNE SIPHON / SENZA SIFONE  
Ref: 432 00 000

Not available for the 120 cm size. Nicht verfügbar für die Größe 120 cm. Non disponibile per la misura di 120 cm.

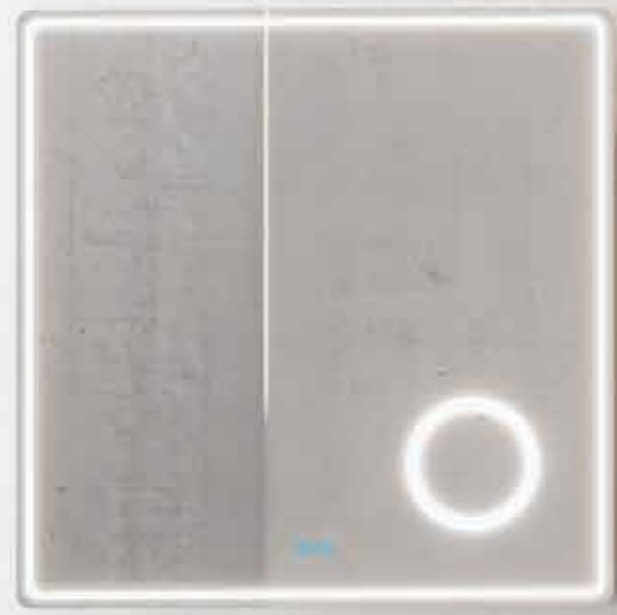

# HOLE

80 | 90 | 100





## HOLE 90

- 132 24 090 Hole 90
- 542 25 090 Mara Countertop Leaf / Abdeckung / Piano
- 425 14 070 Reinforcement Bar 70 / Waschtischplatten-Stabilisierung / Barra di rinforzo
- 518 25 051 Masai Leaf
- 247 00 070 Verona Rond
- 137 24 435 Joker Medium Natural Oak / Mittel / Medio
- 412 00 807 Combi Tall Gold / Hoch / Alto

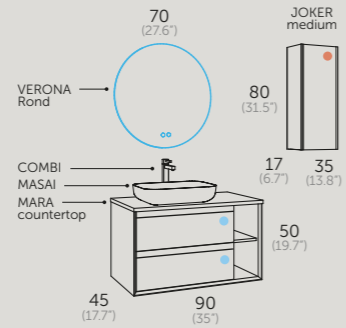

Natural Oak

Grey Pine



Organizer unit.  
Utensilien Behälter.  
Organizzatore.



Adjustable front.  
Einstellbare Vorderseite.  
Frontali regolabili.



Soft close.  
Soft-close-System.  
Chiusura ammortizzata.



Hettich sliding system.  
Korpusschiene Hettich.  
Guide Hettich.



Soft close.  
Soft-close-System.  
Chiusura ammortizzata.



Anti fog system.  
Anti-Beschlag-System.  
Sistema antiappannamento.



Ambient light.  
Umgebungslicht.  
Luce ambiente.



Intensity control.  
Intensitätsregler.  
Regolatore di intensità.



Dual sensor On/Off-anti fog.  
Doppelter Sensorschalter On/Off.  
Doppio sensore touch. On/Off.  
Antiappannante.



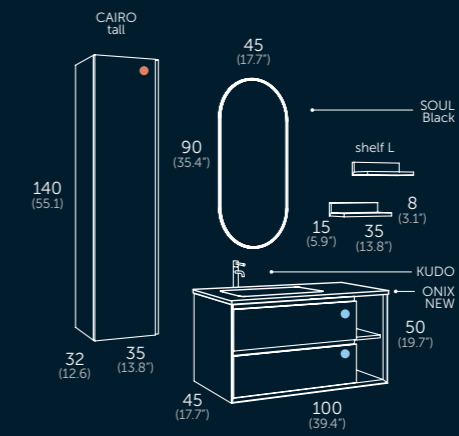

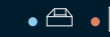

## HOLE 100

- 132 37 100 Hole 100
- 550 01 101 Onix New (70+30) Left / Links / Sinistra
- 239 02 090 Soul Black
- 194 37 335 Cairo Tall Grey Pine / Hoch / Alto
- 112 37 520 Shelf L Grey Pine / Regal L / Scaffale L
- 112 35 520 Shelf L Matte White / Regal L / Scaffale L
- 412 02 810 Kudo Black



 Organizer unit. Utensilien Behälter.  
Organizzatore.

 Adjustable front. Einstellbare  
Vorderseite. Frontali regolabili.

 Soft close. Soft-close-System.  
Chiusura ammortizzata.

 Hettich sliding system. Korpuschiene  
Hettich. Guide Hettich.

 Soft close. Soft-close-System.  
Chiusura ammortizzata.

Natural Oak

Grey Pine

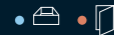

### HOLE 80 (31.49")

Finishes: Natural Oak, Grey Pine

Reference: 132 24 080, 132 37 080

### HOLE 90 (35.43")

Finishes: Natural Oak, Grey Pine

Reference: 132 24 090, 132 37 090

### HOLE 100 (39.37")

Finishes: Natural Oak, Grey Pine

Reference: 132 24 100, 132 37 100

### SPECIAL DRAWER / SPEZIALSCHUBLADE / CASSETTO SPECIALE

Check all the information on page 429. Konsultieren Sie alle Informationen auf Seite 429. Consulta tutte le informazioni nella pagina 429.

**WITHOUT SIPHON CUTOUT** / OHNE SIPHON / SENZA SIFONE  
Ref: 432 00 000

### LANDES COUNTERTOP / ABDECKUNG / PIANO

46	cm	Natural Oak	Grey Pine
80	cm	112 24 208	112 37 208
90	cm	112 24 209	112 37 209
100	cm	112 24 210	112 37 210

**REINFORCEMENT BAR ALUMINIO**

60	cm	Reference
70	cm	425 14 060
80	cm	425 14 070

Its installation is necessary to prevent deformation of the countertop. Seine Installation ist notwendig, um Verformungen der Platte zu vermeiden. La sua installazione è necessaria per prevenire deformazioni nella superficie.

### washbasin / Waschbecken / lavabo

<b>ONIX NEW ceramic</b> Reference: 550 01 081 (Glossy White), 552 XX 081 (Matte Colour)	<b>AMBAR / MARA</b> Reference: 506 01 081 (Solid Surface), 540 XX 081 (Resin Colour)	<b>AMBAR / MARA countertop</b> Reference: 508 01 080 (Solid Surface), 542 XX 080 (Resin Colour)	<b>MYTHO countertops</b> Reference: 532 76 080 (Carrara), 532 77 080 (Marquina Storm), 532 95 080 (Pure Cement)

<b>ONIX NEW ceramic</b> Reference: 550 01 091 (Glossy White)	<b>AMBAR / MARA</b> Reference: 506 01 092 (Solid Surface), 540 XX 092 (Resin Colour)	<b>AMBAR / MARA countertop</b> Reference: 508 01 090 (Solid Surface), 542 XX 090 (Resin Colour)	<b>AMBAR/MARA plinthead countertop</b> Reference: 525 01 090 (Solid Surface), 543 XX 090 (Resin Colour)

<b>ONIX NEW ceramic</b> Reference: 550 01 101 (Glossy White)	<b>AMBAR / MARA</b> Reference: 506 01 107 (Solid Surface), 540 XX 101 (Resin Colour)	<b>AMBAR / MARA countertop</b> Reference: 508 01 100 (Solid Surface), 542 XX 100 (Resin Colour)	<b>MYTHO carrara</b> Reference: 532 76 100 (Carrara), 532 77 100 (Marquina Storm), 532 95 100 (Pure Cement)

### taps / Armaturen / rubinetti

<b>COMBI tap</b> Reference: 412 00 800 (Chrome), 412 00 801 (Black), 412 00 802 (Gold), 412 XX 803 (Full Color)	<b>COMBI TALL tap</b> Reference: 412 00 805 (Chrome), 412 00 806 (Black), 412 00 807 (Gold), 412 XX 804 (Full Color)	<b>KUDO tap</b> Reference: 412 04 810 (Brushed Steel), 412 02 810 (Black), 412 03 810 (Brushed Gold), 412 XX 811 (Full Color)	<b>KUDO TALL tap</b> Reference: 412 04 815 (Steel), 412 02 815 (Black), 412 03 815 (Brushed Gold), 412 XX 816 (Colour)	<b>WALL-MOUNTED tap</b> Reference: 412 00 808 (Chrome), 412 02 808 (Black), 412 03 808 (Gold)

### countertop washbasins / Aufsatzwaschbecken / lavabi da appoggio

<b>DUE ceramic</b> Reference: 530 01 002 (Glossy White)	<b>OTTO ceramic</b> Reference: 530 01 008 (Glossy White), 535 XX 008 (Matte Colour)	<b>CORINTO/BARBADOS</b> Reference: 582 01 037 (Solid Surface), 583 XX 037 (Resin Colour)	<b>MYKONOS/CURAZAO</b> Reference: 584 01 034 (Solid Surface), 585 XX 034 (Resin Colour)	<b>ARUBA resin deco</b> Reference: 581 76 037 (Carrara), 581 77 037 (Marquina Storm), 581 95 037 (Pure cement)

**DRILLING SERVICE** Replace the XX by the chosen colour code. See codes on page 447. Esetzen Sie XX durch den Code der ausgewählten Farbe. Siehe Seite 447 für Farbcodes. Sostituire l'XX con il codice colore scelto. Vedere i codici a pagina 447. Ref: 435 00 050

### mirrors / Spiegel / specchi

MORE OPTIONS SEE PAGES 327-434

<b>SUN</b> Reference: 204 00 080	<b>NITRO</b> Reference: 241 00 080	<b>SOUL</b> Reference: 239 02 090 (BLACK), 239 72 090 (GOLD)	<b>RAIN LED</b> Reference: 269 00 080	<b>VERONA ROND LED</b> Reference: 247 00 080	<b>COSMOS LED</b> Reference: 270 00 080	<b>AURA LED</b> Reference: 250 02 080	<b>VERONA LED</b> Reference: 246 00 080
<b>SUN</b> Reference: 204 00 090	<b>ROND</b> Reference: 244 00 090	<b>ROND</b> Reference: 249 02 070 (BLACK), 244 72 070 (GOLD)	<b>RAIN LED</b> Reference: 269 00 070	<b>VERONA ROND LED</b> Reference: 247 00 070	<b>JAZZ LED</b> Reference: 271 02 050	<b>AURA LED</b> Reference: 250 02 070	<b>VERONA LED</b> Reference: 246 00 070

<b>SUN</b> Reference: 204 00 100	<b>NITRO</b> Reference: 241 00 100	<b>SOUL</b> Reference: 239 02 080 (BLACK), 239 72 080 (GOLD)	<b>RAIN LED</b> Reference: 269 00 100	<b>VERONA ROND LED</b> Reference: 247 00 100	<b>COSMOS LED</b> Reference: 270 00 100	<b>AURA LED</b> Reference: 250 02 100	<b>VERONA LED</b> Reference: 246 00 100

### accessories / Zubehör / complementi

<b>DRAIN clic clac</b> Reference: 410 02 203 (Black), 410 01 203 (White), 410 03 203 (Brushed Gold)	<b>DRAIN clic clac</b> Reference: 409 XX 203 (Colour)	<b>LUX 38 towel rail</b> Reference: 417 00 038 (Chrome), 417 02 038 (Black), 417 27 038 (White)	<b>ADHESIVE 3M towel rail</b> Reference: 416 00 037 (Chrome), 416 02 037 (Black)	<b>HAIR DRYER support</b> Reference: 419 02 001 (Black), 419 00 001 (Chrome)	<b>NEREA MATTE 30</b> Reference: 400 14 141	<b>ESTHER BLACK 45</b> Reference: 400 02 191

### spotlights / LED Beleuchtung / lampade da muro

### side cabinets / Hängeschränke / armadi

<b>CAIRO TALL</b> Reference: 194 24 335 (Natural Oak), 194 37 335 (Grey Pine) Reversible opening   Umkehrbare Öffnung   Apertura reversibile	<b>JOKER MEDIUM</b> Reference: 137 24 435 (Natural Oak), 137 37 435 (Grey Pine) Reversible opening   Umkehrbare Öffnung   Apertura reversibile	<b>JOKER SMALL</b> Reference: 137 24 445 (Natural Oak), 137 37 445 (Grey Pine) Reversible opening   Umkehrbare Öffnung   Apertura reversibile



# GALSAKY

COMPACT / MODULAR

60 to 200

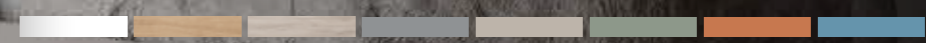



-  Organizer unit.  
Utensilien Behälter.  
Organizattore.
-  Adjustable front.  
Einstellbare Vorderseite.  
Frontali regolabili.
-  Soft close.  
Soft-close-System.  
Chiusura ammortizzata.
-  Hettich sliding system.  
Körpuschiene Hettich.  
Guide Hettich.
-  Soft close.  
Soft-close-System.  
Chiusura ammortizzata.
-  Anti fog system.  
Anti-Beschlag-System.  
Sistema antihappannamento.
-  Ambient light.  
Umgebungslicht.  
Luce ambiente.
-  Dual sensor On/Off-anti fog.  
Doppelter Sensorschalter. On/Off.  
Doppio sensore touch. On/Off.  
Antiappannante.
-  Intensity control.  
Intensitätsregler.  
Regolatore di intensità.

FURNITURE	HANDLES
Glossy White	Matte Chrome
Natural Oak	Matte Black
Grey Pine	Matte Gold
Matte Mist	
Matte Mink	
Matte Leaf	
Matte Sunset	
Matte Island	

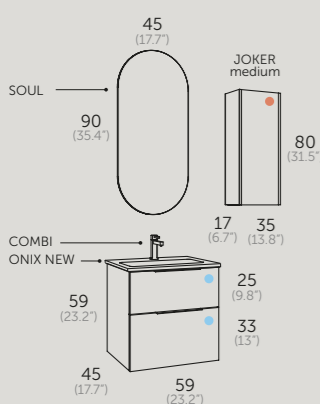

- GALSAKY 60**
- 151 49 060 C Galsaky 60
  - 550 01 060 Onix New
  - 239 00 090 Soul
  - 137 49 435 Joker Medium Island / Mittel / Medio
  - 412 00 800 Combi Chrome

- GALSAKY 70**
- 151 74 070 G Galsaky 70
  - 506 01 070 G Ambar  
without tap drilling / Ohne Bohrung für  
den Wasserhahn / Senza fori per il rubinetto
  - 247 00 070 Verona Rond
  - 137 74 445 Joker Small Mink / Klein / Piccolo
  - 112 47 520 Shelf L Leaf / Regal L / Scaffale L
  - 412 03 808 Combi Wall-Mounted Gold

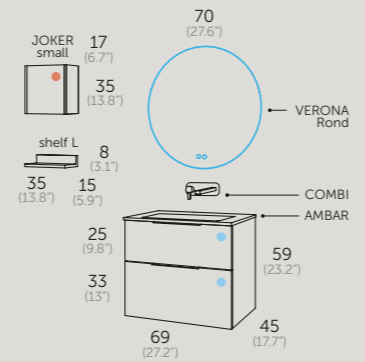

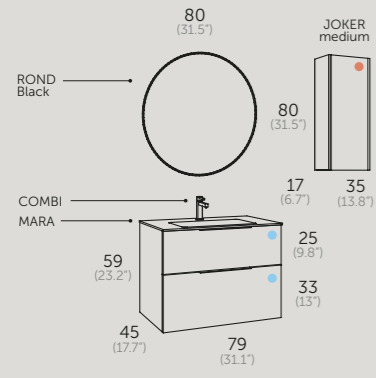

**GALSAKY 80**

- 151 24 080 N Galsaky 80
- 540 02 080 Mara Black
- 244 02 080 Rond Black
- 137 24 435 Joker Medium Natural Oak / Mittel / Medio
- 412 00 801 Combi Black



**FURNITURE**

- Glossy White
- Natural Oak
- Grey Pine
- Matte Mist
- Matte Mink
- Matte Leaf
- Matte Sunset
- Matte Island

**HANDLES**

- Matte Chrome
- Matte Black
- Matte Gold

-  Organizer unit.  
Utensilien Behälter.  
Organizzatore.
-  Adjustable front.  
Einstellbare Vorderseite.  
Frontali regolabili.
-  Soft close.  
Soft-close-System.  
Chiusura ammortizzata.
-  Hettich sliding system.  
Körpuschiene Hettich.  
Guide Hettich.
-  Soft close.  
Soft-close-System.  
Chiusura ammortizzata.



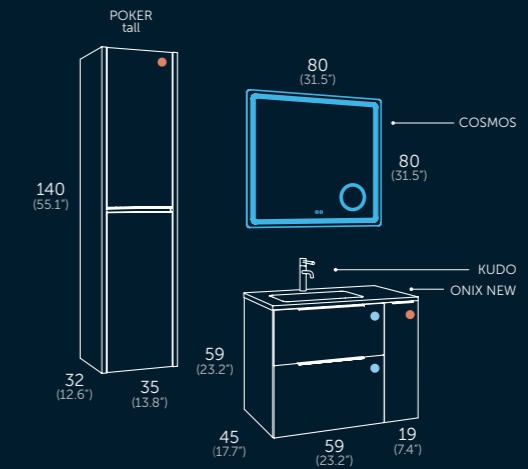

## GALSAKY MODULAR 80

- 151 01 060 G Galsaky 60
- 151 01 020 G Galsaky Module Door 20 / Türmodul / Modulo porta
- 550 01 081 Onix New (60+20) Left / Links / Sinistra
- 405 01 000 Overflow Cover Glossy White / Überlaufabdeckung / Copertura del troppo pieno
- 270 00 080 Cosmos
- 167 01 335 G Poker Tall Glossy White / Hoch / Tall
- 412 03 810 Kudo Brushed Gold / Gebürstet / Spazzolato

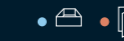

- Organizer unit. Utensilien Behälter. Organizzatore.
- Adjustable front. Einstellbare Vorderseite. Frontali regolabili.
- Soft close. Soft-close-System. Chiusura ammortizzata.
- Hettich sliding system. Korpussschiene Hettich. Guide Hettich.
- Soft close. Soft-close-System. Chiusura ammortizzata.
- Glossy lacquered finish. Glänzend lackiert. Laccato lucido.
- Anti fog system. Anti-Beschlag-System. Sistema antiappannamento.
- Magnifying zoom in Mirror. Lupe 3x. Vergrößerung. Lente d'ingrandimento 3x.
- Dual sensor On/Off-anti fog. Doppelter Sensorschalter. On/Off. Doppia sensore di con tatto. On/Off. Antappannante.

### FURNITURE





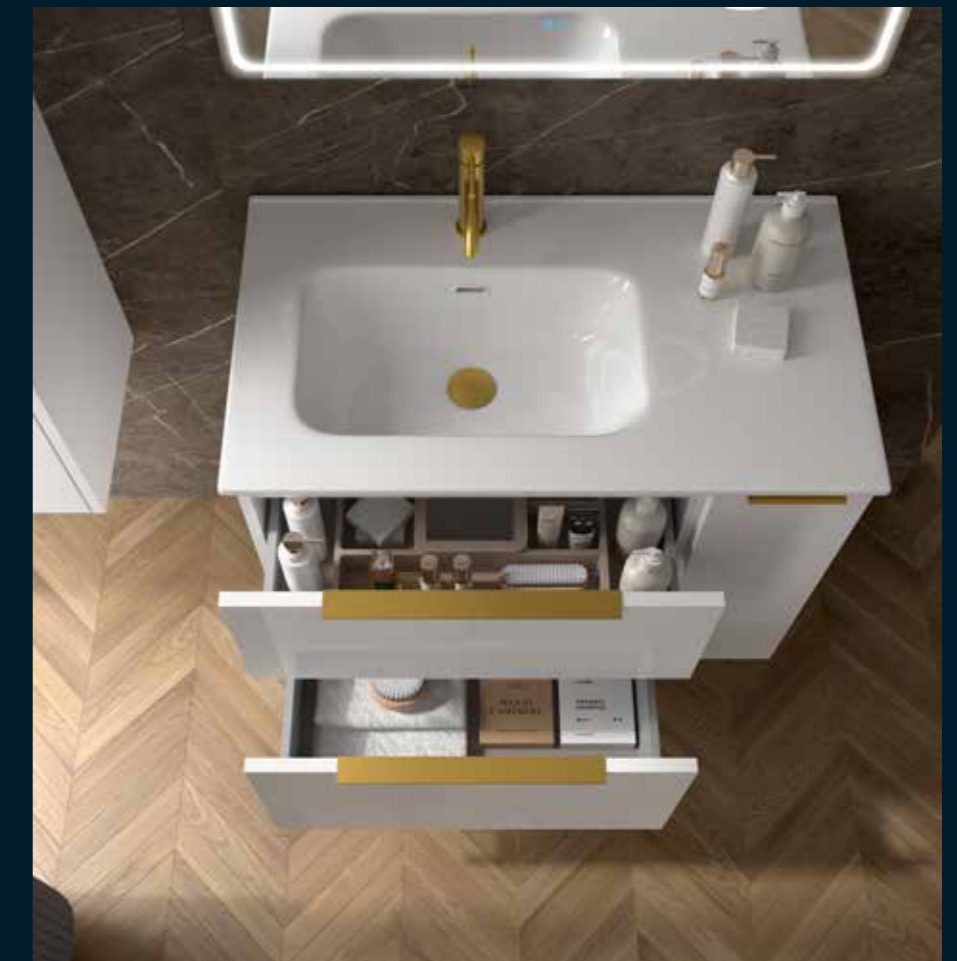

- Glossy White
- Natural Oak
- Grey Pine
- Matte Mist
- Matte Mink
- Matte Leaf
- Matte Sunset
- Matte Island

### HANDLES

- Matte Chrome
- Matte Black
- Matte Gold





-  Organizer unit.  
Utensilien Behälter.  
Organizzatori.
-  Adjustable front.  
Einstellbare Vorderseite.  
Frontali regolabili.
-  Soft close.  
Soft-close-System.  
Chiusura ammortizzata.
-  Hettich sliding system.  
Korpusschiene Hettich.  
Guide Hettich.
-  Soft close.  
Soft-close-System.  
Chiusura ammortizzata.
-  Anti fog system.  
Anti-Beschlag-System.  
Sistema antiappannamento.
-  Dual sensor On/Off-anti fog.  
Doppelter Sensorschalter. On/Off.  
Doppio sensore touch. On/Off.  
Antiappannante.

**FURNITURE**

- Glossy White
- Natural Oak
- Grey Pine
- Matte Mist
- Matte Mink
- Matte Leaf
- Matte Sunset
- Matte Island

**HANDLES**

- Matte Chrome
- Matte Black
- Matte Gold

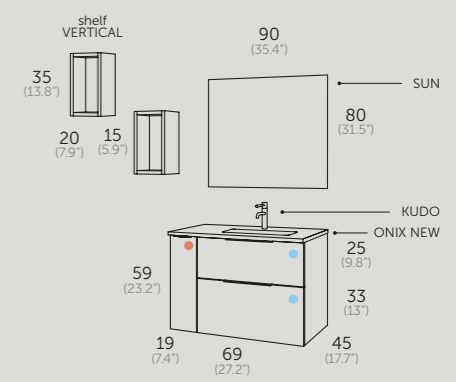
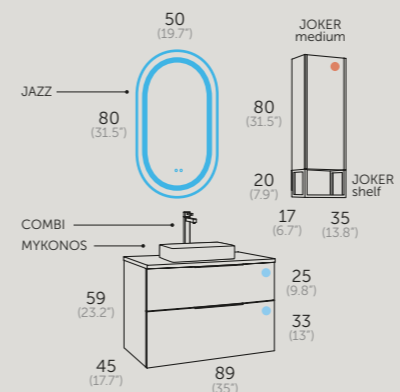

**GALSAKY 90**

- 151 71 090 N Galsaky 90
- 584 01 034 Mykonos
- 508 01 090 Ambar Countertop / Abdeckung / Piano  
Reinforcement Bar / Waschtischplatten-Stabilisierung  
/ Barra di rinforzo
- 425 14 090 Jazz
- 271 02 050 Joker Medium Mist / Mittel / Medio
- 137 71 435 Joker Shelf Mist / Regal / Scaffale
- 137 71 455 Joker Shelf Mist / Regal / Scaffale
- 412 00 806 Combi Tall Black / Hoch / Alto



**GALSAKY MODULAR 90**

- 151 48 070 C Galsaky 70
- 151 48 020 C Galsaky Module Door 20 / Türmodul / Modulo Porta
- 550 01 093 Onix New (20+70) Right / Rechts / Destra
- 294 00 090 Sun
- 112 48 510 Shelf Vertical Sunset / Vertikales Regal  
/ Scaffale Verticale
- 112 35 510 Shelf Vertical White / Vertikales Regal  
/ Scaffale Verticale
- 412 04 810 Kudo Brushed Steel / Gebürstet / Spazzolato



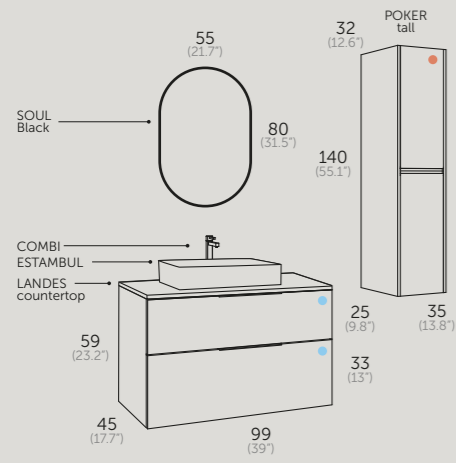

## GALSAKY 100

151 47 100 N	Galsaky 100
507 01 005	Estambul
112 24 210	Landes Countertop Natural Oak / Abdeckung / Piano
425 14 100	Reinforcement Bar / Waschtischplatten-Stabilisierung / Barra di rinforzo
239 02 080	Soul Black
167 47 335 N	Poker Tall Leaf / Hock / Alto
412 00 806	Combi Tall Black / Hock / Alto







### FURNITURE

- Glossy White
- Natural Oak
- Grey Pine
- Matte Mist
- Matte Mink
- Matte Leaf
- Matte Sunset
- Matte Island

### HANDLES

- Matte Chrome
- Matte Black
- Matte Gold

-  Organizer unit.  
Utensilien Behälter.  
Organizzatori.
-  Adjustable front.  
Einstellbare Vorderseite.  
Frontali regolabili.
-  Soft close.  
Soft-close-System.  
Chiusura ammortizzata.
-  Hettich sliding system.  
Körpusschiene Hettich.  
Guide Hettich.
-  Soft close.  
Soft-close-System.  
Chiusura ammortizzata.



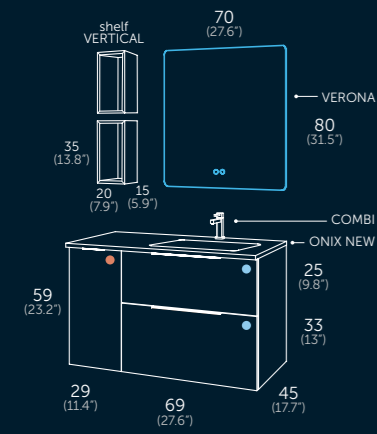

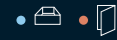

## GALSAKY MODULAR 100

- 151 24 070 N Galsaky 70
- 151 24 030 N Galsaky Module Door 30 / Türmodul / Modulo porta
- 550 01 103 Onix New (30+70) Right / Rechts / Destra
- 246 00 070 Verona
- 112 24 510 Shelf Vertical Natural Oak / Vertikales Regal / Scaffale Verticale
- 412 00 801 Combi Black



-  Organizer unit. Utensilien Behälter. Organizzatore.
-  Adjustable front. Einstellbare Vorderseite. Frontali regolabili.
-  Soft close. Soft-close-System. Chiusura ammortizzata.
-  Hettich sliding system. Korpuschiene Hettich. Guide Hettich.
-  Soft close. Soft-close-System. Chiusura ammortizzata.
-  Anti fog system. Anti-Beschlag-System. Sistema antiappannamento.
-  Ambient light. Umgebungslicht. Luce ambiente.
-  Intensity control. Intensitätsregler. Regolatore di intensità.
-  Dual sensor On/Off-anti fog. Doppelter Sensorschalter. On/Off. Doppio sensore di con tatto. On/Off. Antihappannante.

### FURNITURE

- Glossy White
- Natural Oak
- Grey Pine
- Matte Mist
- Matte Mink
- Matte Leaf
- Matte Sunset
- Matte Island

### HANDLES

- Matte Chrome
- Matte Black
- Matte Gold

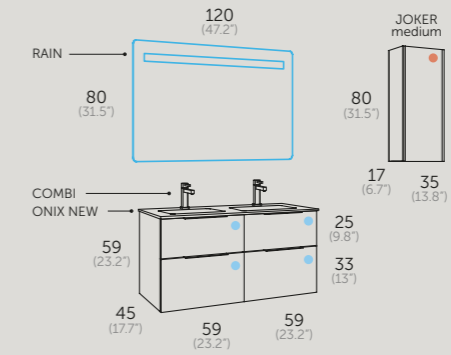

## GALSAKY MODULAR 120

- 151 71 060 N Galsaky 60
- 550 01 122 Onix New 2s
- 269 00 120 Rain
- 137 71 435 Joker Medium Mist / Mittel / Medio
- 412 00 801 Combi Black



Organizer unit.  
Utensilien Behälter.  
Organizzatore.



Adjustable front.  
Einstellbare Vorderseite.  
Frontali regolabili.



Soft close.  
Soft-close-System.  
Chiusura ammortizzata.



Hettich sliding system.  
Korpusschiene Hettich.  
Guida Hettich.



Soft close.  
Soft-close-System.  
Chiusura ammortizzata.

### FURNITURE

Glossy White

Natural Oak

Grey Pine

Matte Mist

Matte Mink

Matte Leaf

Matte Sunset

Matte Island

### HANDLES

Matte Chrome

Matte Black

Matte Gold

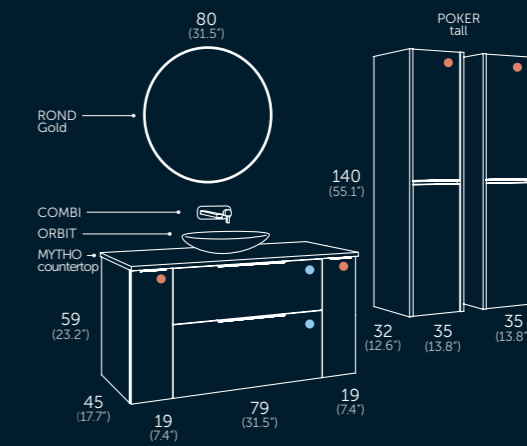

## GALSAKY MODULAR 120

- 151 74 080 G Galsaky 80
- 151 74 020 G Galsaky Module Door 20 / Türmodul / Modulo porta
- 532 77 120 Mytho Marquina Storm Countertop / Abdeckung / Piano
- 425 14 080 Reinforcement Bar 80 / Waschtischplatten-Stabilisierung / Barra di rinforzo
- 518 19 057 Orbit Mink
- 244 72 080 Rond Gold
- 167 74 335 G Poker Tall Mink / Hoch / Tall
- 412 03 808 Combi Wall-Mounted Gold







### FURNITURE

- Glossy White
- Natural Oak
- Grey Pine
- Matte Mist
- Matte Mink
- Matte Leaf
- Matte Sunset
- Matte Island

### HANDLES

- Matte Chrome
- Matte Black
- Matte Gold

-  Organizer unit, Utensilien Behälter, Organizzatore.
-  Adjustable front, Einstellbare Vorderseite, Frontali regolabili.
-  Soft close, Soft-close-System, Chiusura ammortizzata.
-  Hettich sliding system, Korpuschiene Hettich, Guide Hettich.
-  Soft close, Soft-close-System, Chiusura ammortizzata.

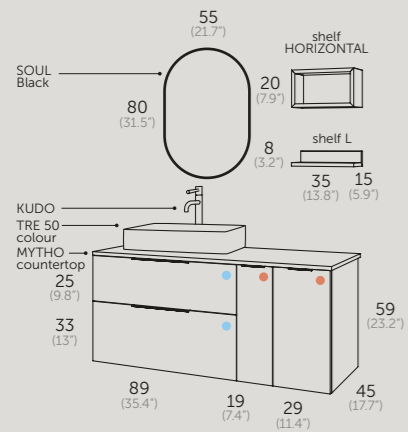

## GALSAKY MODULAR 140

- 151 47 090 N Galsaky 90
- 151 24 020 N Galsaky Module Door 20 / Türmodul / Modulo Porta
- 151 47 030 N Galsaky Module Door 30 / Türmodul / Modulo Porta
- 532 77 140 Mytho Marquina Storm Countertop / Abdeckung / Piano
- 425 14 090 Reinforcement Bar 90 / Waschtischplatten-Stabilisierung / Barra di rinforzo
- 535 02 035 Tre 50 Colour Black
- 239 02 080 Soul Black
- 112 47 505 Shelf Horizontal Leaf / Horizontales Regal / Scaffale Orizzontale
- 112 24 520 Shelf L Natural Oak / Regal L / Scaffale L
- 412 02 815 Kudo Tall Black / Hoch / Alto



### FURNITURE

- Glossy White
- Natural Oak
- Grey Pine
- Matte Mist
- Matte Mink
- Matte Leaf
- Matte Sunset
- Matte Island

### HANDLES

- Matte Chrome
- Matte Black
- Matte Gold



Organizer unit.  
Utensilien Behälter.  
Organizzatore.



Adjustable front.  
Einstellbare Vorderseite.  
Frontali regolabili.



Soft close.  
Soft-close-System.  
Chiusura ammortizzata.



Hettich sliding system.  
Korpuschiene Hettich.  
Guide Hettich.



Soft close.  
Soft-close-System.  
Chiusura ammortizzata.



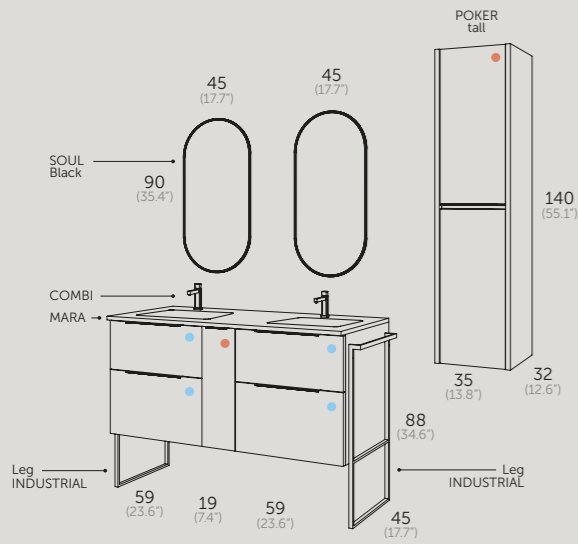

## GALSAKY MODULAR 140

- 151 24 060 N Galsaky 60
- 151 24 020 N Galsaky Module Door 20 / Türmodul / Modulo porta
- 412 02 752 Leg IND with towel rail / Bein IND mit Handtuchhalter / Gamba IND con porta asciugamani
- 412 02 750 Leg IND without towel rail / Bein IND ohne Handtuchhalter / Gamba IND senza porta asciugamani
- 632 02 002 Mara 2s. (custom-made) Black
- 239 02 090 Soul Black
- 167 24 335 N Poker Tall Natural Oak / Hoch / Alto
- 412 24 801 Combi Black - Natural Oak



Organizer unit.  
Utensilien Behälter.  
Organizzatore.



Adjustable front.  
Einstellbare Vorderseite.  
Frontali regolabili.



Soft close.  
Soft-close-System.  
Chiusura ammortizzata.



Hettich sliding system.  
Körpuschiene Hettich.  
Guide Hettich.



Soft close.  
Soft-close-System.  
Chiusura ammortizzata.

### FURNITURE

Glossy White

Natural Oak

Grey Pine

Matte Mist

Matte Mink

Matte Leaf

Matte Sunset

Matte Island

### HANDLES

Matte Chrome

Matte Black

Matte Gold



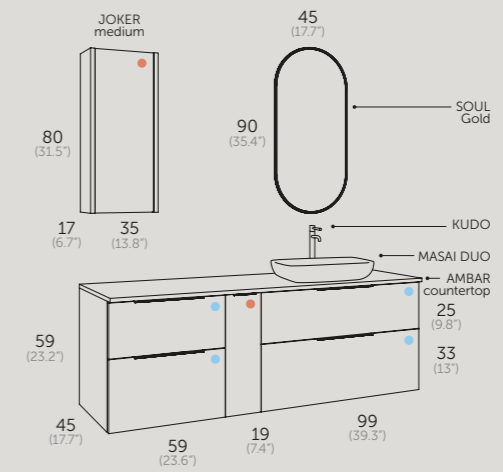

## GALSAKY MODULAR 180

- 151 37 100 G Galsaky 100
- 151 37 060 G Galsaky 60
- 151 49 020 G Galsaky Module Door 20 / Türmodul / Modulo porta
- 508 01 180 Ambar Countertop / Abdeckung / Piano
- 425 14 100 Reinforcement Bar 100 / Waschtischplatten-Stabilisierung / Barra di rinforzo
- 523 23 051 Masai Duo Island
- 239 72 090 Soul Gold
- 137 49 435 Joker Medium Island / Mittel / Medio
- 412 03 815 Kudo Tall Gold Brushed / Hoch / Alto



Organizer unit.  
Utensilien Behälter.  
Organizzatore.



Adjustable front.  
Einstellbare Vorderseite.  
Frontali regolabili.



Soft close.  
Soft-close-System.  
Chiusura ammortizzata.



Hettich sliding system.  
Korpusschiene Hettich.  
Guide Hettich.



Soft close. ZZChiusura ammortizzata.

### FURNITURE

Glossy White

Natural Oak

Grey Pine

Matte Mist

Matte Mink

Matte Leaf

Matte Sunset

Matte Island

### HANDLES

Matte Chrome

Matte Black

Matte Gold

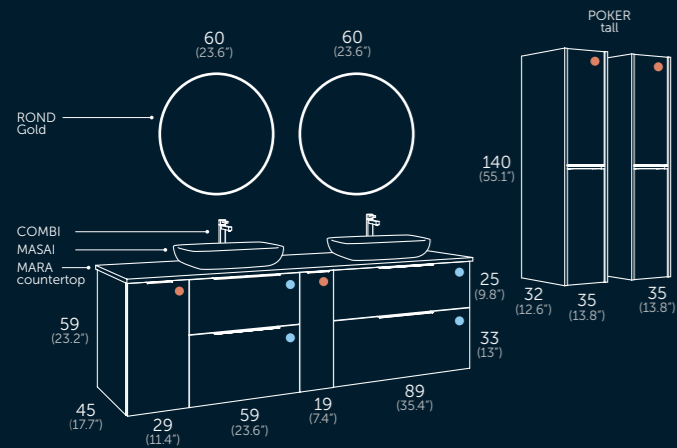

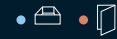

## GALSAKY MODULAR 200

- 151 74 090 G Galsaky 90
- 151 48 060 G Galsaky 60
- 151 48 020 G Galsaky Module Door 20 / Türmodul / Modulo Porta
- 151 74 030 G Galsaky Module Door 30 / Türmodul / Modulo Porta
- 542 06 200 Mara Countertop White / Abdeckung / Piano
- 425 14 090 Reinforcement Bar 90 / Waschtischplatten-Stabilisierung / Barra di rinforzo
- 425 14 060 Reinforcement Bar 60 / Waschtischplatten-Stabilisierung / Barra di rinforzo
- 518 19 051 Masai Mink
- 244 72 060 Rond Gold
- 167 74 335 G Poker Tall Mink / Hoch / Alto
- 167 48 335 G Poker Tall Sunset / Hoch / Alto
- 412 00 807 Combi Tall Gold / Hoch / Alto



 Organizer unit. Utensilien Behälter. Organizzatore.

 Adjustable front. Einstellbare Vorderseite. Frontali regolabili.

 Soft close. Soft-close-System. Chiusura ammortizzata.

 Hettich sliding system. Korpuschiene Hettich. Guide Hettich.

 Soft close. Soft-close-System. Chiusura ammortizzata.

### FURNITURE

Glossy White

Natural Oak

Grey Pine

Matte Mist

Matte Mink

Matte Leaf

Matte Sunset

Matte Island

### HANDLES

Matte Chrome

Matte Black

Matte Gold



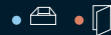

## GALSAKY 60 (23.62")

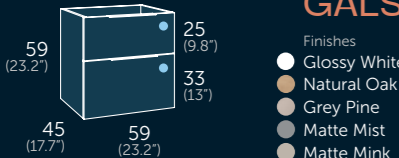

Replace the X with the handle colour reference:  
Ersetzen Sie das X mit der Farbreferenz des Griffs:  
Sostituire la X con il riferimento del colore della maniglia:

- Finishes
- Glossy White
  - Natural Oak
  - Grey Pine
  - Matte Mist
  - Matte Mink
  - Matte Leaf
  - Matte Sunset
  - Matte Island
- Reference
- 151 01 060 (X)
  - 151 24 060 (X)
  - 151 37 060 (X)
  - 151 71 060 (X)
  - 151 74 060 (X)
  - 151 47 060 (X)
  - 151 48 060 (X)
  - 151 49 060 (X)
- Chrome (C) ○ Black (N) ● Gold (G)

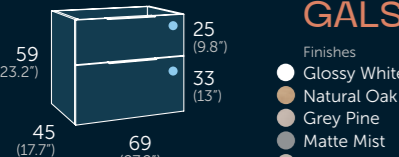

Replace the X with the handle colour reference:  
Ersetzen Sie das X mit der Farbreferenz des Griffs:  
Sostituire la X con il riferimento del colore della maniglia:

- Finishes
- Glossy White
  - Natural Oak
  - Grey Pine
  - Matte Mist
  - Matte Mink
  - Matte Leaf
  - Matte Sunset
  - Matte Island
- Reference
- 151 01 070 (X)
  - 151 24 070 (X)
  - 151 37 070 (X)
  - 151 71 070 (X)
  - 151 74 070 (X)
  - 151 47 070 (X)
  - 151 48 070 (X)
  - 151 49 070 (X)
- Chrome (C) ○ Black (N) ● Gold (G)

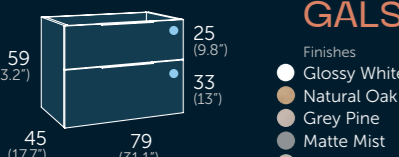

Replace the X with the handle colour reference:  
Ersetzen Sie das X mit der Farbreferenz des Griffs:  
Sostituire la X con il riferimento del colore della maniglia:

- Finishes
- Glossy White
  - Natural Oak
  - Grey Pine
  - Matte Mist
  - Matte Mink
  - Matte Leaf
  - Matte Sunset
  - Matte Island
- Reference
- 151 01 080 (X)
  - 151 24 080 (X)
  - 151 37 080 (X)
  - 151 71 080 (X)
  - 151 74 080 (X)
  - 151 47 080 (X)
  - 151 48 080 (X)
  - 151 49 080 (X)
- Chrome (C) ○ Black (N) ● Gold (G)

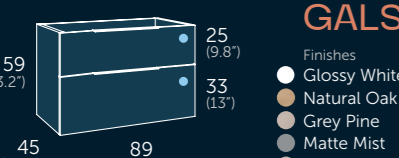

Replace the X with the handle colour reference:  
Ersetzen Sie das X mit der Farbreferenz des Griffs:  
Sostituire la X con il riferimento del colore della maniglia:

- Finishes
- Glossy White
  - Natural Oak
  - Grey Pine
  - Matte Mist
  - Matte Mink
  - Matte Leaf
  - Matte Sunset
  - Matte Island
- Reference
- 151 01 090 (X)
  - 151 24 090 (X)
  - 151 37 090 (X)
  - 151 71 090 (X)
  - 151 74 090 (X)
  - 151 47 090 (X)
  - 151 48 090 (X)
  - 151 49 090 (X)
- Chrome (C) ○ Black (N) ● Gold (G)

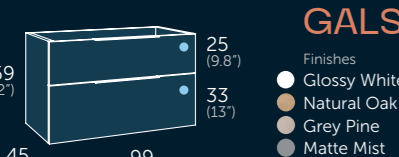

Replace the X with the handle colour reference:  
Ersetzen Sie das X mit der Farbreferenz des Griffs:  
Sostituire la X con il riferimento del colore della maniglia:

- Finishes
- Glossy White
  - Natural Oak
  - Grey Pine
  - Matte Mist
  - Matte Mink
  - Matte Leaf
  - Matte Sunset
  - Matte Island
- Reference
- 151 01 100 (X)
  - 151 24 100 (X)
  - 151 37 100 (X)
  - 151 71 100 (X)
  - 151 74 100 (X)
  - 151 47 100 (X)
  - 151 48 100 (X)
  - 151 49 100 (X)
- Chrome (C) ○ Black (N) ● Gold (G)

## LANDES COUNTERTOP

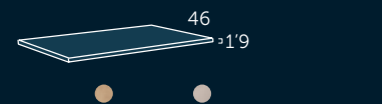

cm	Natural Oak	Grey Pine
60	112 24 206	112 37 206
70	112 24 207	112 37 207
80	112 24 208	112 37 208
90	112 24 209	112 37 209
100	112 24 210	112 37 210



cm	Reference
60	425 14 060
70	425 14 070
80	425 14 080
90	425 14 090
100	425 14 100



**ONIX NEW ceramic**  
Reference  
● Glossy White  
550 01 060  
● Matte Colour  
552 XX 060

**AMBAR / MARA**  
Reference  
● Solid Surface  
506 01 060  
● Resin Colour  
540 XX 060

**ZEN / IRIS**  
Reference  
● Solid Surface  
555 01 060  
● Resin Colour  
536 XX 060

**QUATTRO ceramic**  
Reference  
● Glossy White  
522 01 060

**AMBAR / MARA countertop**  
Reference  
● Solid Surface  
508 01 060  
● Resin Colour  
542 XX 060



**ONIX NEW ceramic**  
Reference  
● Glossy White  
550 01 070  
● Matte Colour  
552 XX 070

**AMBAR / MARA**  
Reference  
● Solid Surface  
506 01 070  
● Resin Colour  
540 XX 070

**ZEN / IRIS**  
Reference  
● Solid Surface  
555 01 070  
● Resin Colour  
536 XX 070

**AMBAR / MARA plinthed**  
Reference  
● Solid Surface  
524 01 070  
● Resin Colour  
541 XX 070

**AMBAR / MARA countertop**  
Reference  
● Solid Surface  
508 01 070  
● Resin Colour  
542 XX 070



**ONIX NEW ceramic**  
Reference  
● Glossy White  
550 01 080  
● Matte Colour  
552 XX 080

**AMBAR / MARA**  
Reference  
● Solid Surface  
506 01 080  
● Resin Colour  
540 XX 080

**ZEN / IRIS**  
Reference  
● Solid Surface  
555 01 080  
● Resin Colour  
536 XX 080

**QUATTRO ceramic**  
Reference  
● Glossy White  
522 01 080

**AMBAR / MARA countertop**  
Reference  
● Solid Surface  
508 01 080  
● Resin Colour  
542 XX 080



**ONIX NEW ceramic**  
Reference  
● Glossy White  
550 01 090

**AMBAR / MARA**  
Reference  
● Solid Surface  
506 01 090  
● Resin Colour  
540 XX 090

**ZEN / IRIS**  
Reference  
● Solid Surface  
555 01 090  
● Resin Colour  
536 XX 090

**AMBAR / MARA plinthed**  
Reference  
● Solid Surface  
524 01 090  
● Resin Colour  
541 XX 090

**AMBAR / MARA countertop**  
Reference  
● Solid Surface  
508 01 090  
● Resin Colour  
542 XX 090



**ONIX NEW ceramic**  
Reference  
● Glossy White  
550 01 100

**AMBAR / MARA**  
Reference  
● Solid Surface  
506 01 100  
● Resin Colour  
540 XX 100

**ZEN / IRIS**  
Reference  
● Solid Surface  
555 01 100  
● Resin Colour  
536 XX 100

**QUATTRO ceramic**  
Reference  
● Glossy White  
522 01 100

**AMBAR / MARA countertop**  
Reference  
● Solid Surface  
508 01 100  
● Resin Colour  
542 XX 100

## countertop basins / Aufsatzwaschbecken / lavabi da appoggio

⚠ Its installation is necessary to prevent deformation of the countertop.  
Seine Installation ist notwendig, um Verformungen der Arbeitsplatte zu verhindern.  
La sua installazione è necessaria per prevenire la deformazione del piano di lavoro.

Replace the XX by the chosen colour code. See codes on page 447.  
Ersetzen Sie XX durch den Code der ausgewählten Farbe. Siehe Seite 447 für Farbcodes.  
Sostituire l'XX con il codice colore scelto. Vedere i codici a pagina 447.



**SEI**  
Reference  
● Glossy White  
530 01 006

**DUE ceramic**  
Reference  
● Glossy White  
530 01 002

**ROTTERDAM ceramic**  
Reference  
● Glossy White  
507 01 004  
● Matte Colour  
535 XX 004



**SUN**  
Reference  
204 00 060

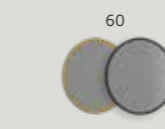

**ROND**  
Reference  
● BLACK  
244 02 060  
● GOLD  
244 72 060

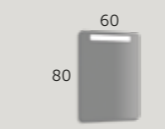

**RAIN LED**  
Reference  
269 00 060

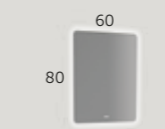

**VERONA LED**  
Reference  
246 00 060



**AURA STRAP LED**  
Reference  
251 02 060



**SUN**  
Reference  
204 00 070



**ROND**  
Reference  
● BLACK  
244 02 070  
● GOLD  
244 72 070



**RAIN LED**  
Reference  
269 00 070



**VERONA LED**  
Reference  
246 00 070



**AURA LED**  
Reference  
250 02 070



**SUN**  
Reference  
204 00 080

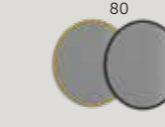

**ROND**  
Reference  
● BLACK  
244 02 080  
● GOLD  
244 72 080



**RAIN LED**  
Reference  
269 00 080



**VERONA LED**  
Reference  
246 00 080



**AURA LED**  
Reference  
250 02 080

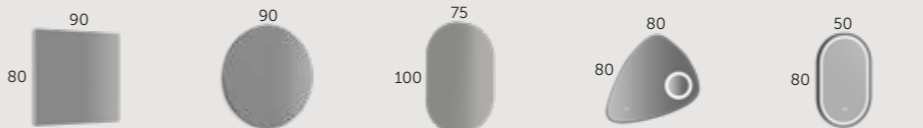

**SUN**  
Reference  
204 00 090



**ROND**  
Reference  
244 00 090

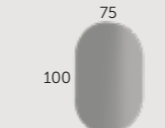

**SOUL**  
Reference  
239 00 100

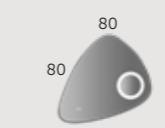

**STONE LED**  
Reference  
261 00 080

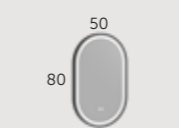

**JAZZ LED**  
Reference  
271 02 050



**SUN**  
Reference  
204 00 100



**ROND**  
Reference  
● BLACK  
244 02 100  
● GOLD  
244 72 100

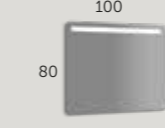

**RAIN LED**  
Reference  
269 00 100



**VERONA LED**  
Reference  
246 00 100

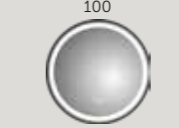

**AURA LED**  
Reference  
250 02 100

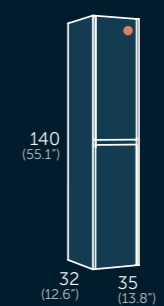

## POKER TALL

- Finishes
- Glossy White
  - Natural Oak
  - Grey Pine
  - Matte Mist
  - Matte Mink
  - Matte Leaf
  - Matte Sunset
  - Matte Island
- Reference
- 167 01 335 (X)
  - 167 24 335 (X)
  - 167 37 335 (X)
  - 167 71 335 (X)
  - 167 74 335 (X)
  - 167 47 335 (X)
  - 167 48 335 (X)
  - 167 49 335 (X)

Replace the X with the handle colour reference:  
Ersetzen Sie das X mit der Farbreferenz des Griffs:  
Sostituire la X con il riferimento del colore della maniglia:

- Chrome (C) ○ Black (N) ● Gold (G)

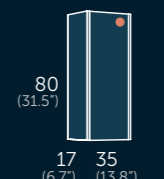

## JOKER MEDIUM

- Finishes
- Glossy White
  - Natural Oak
  - Grey Pine
  - Matte Mist
  - Matte Mink
  - Matte Leaf
  - Matte Sunset
  - Matte Island
- Reference
- 137 01 435
  - 137 24 435
  - 137 37 435
  - 137 71 435
  - 137 74 435
  - 137 47 435
  - 137 48 435
  - 137 49 435

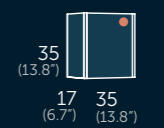

## JOKER SMALL

- Finishes
- Glossy White
  - Natural Oak
  - Grey Pine
  - Matte Mist
  - Matte Mink
  - Matte Leaf
  - Matte Sunset
  - Matte Island
- Reference
- 137 01 445
  - 137 24 445
  - 137 37 445
  - 137 71 445
  - 137 74 445
  - 137 47 445
  - 137 48 445
  - 137 49 445



**COMBI tap**  
Reference  
● Chrome  
412 00 800  
○ Black  
412 00 801  
● Gold  
412 00 802

**KUDO tap**  
Reference  
● Brushed Steel  
412 04 810  
○ Black  
412 02 810  
● Brushed Gold  
412 03 810

**DRAIN clic clac**  
Reference  
● Chrome  
410 00 203  
○ Black  
410 02 203  
● Brushed Gold  
410 03 203

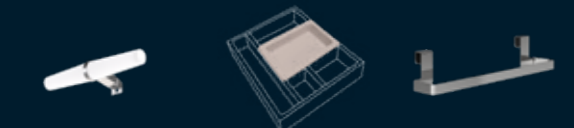

**EVA**  
Reference  
400 00 011

**SIPHON cutout lid**  
Reference  
418 71 000

**LUX 38 towel rail**  
Reference  
● Chrome  
417 00 038  
○ Black  
417 02 038

## SPECIAL DRAWER

### SPZIALSCHUBLADE / CASSETTO SPECIALE

Check all the information on page 429.  
Konsultieren Sie alle Informationen auf Seite 429.  
Consulta tutte le informazioni nella pagina 429.



**OFFSET SIPHON CUTOUT**  
/ VERSCHIEBBARER SIPHON / SIFONE REGOLABILE  
Ref: 432 00 001  
A plan is required. Not available for the 60 cm size.  
Plan erforderlich. Nicht verfügbar für die Größe 60 cm.  
Piano richiesto. Non disponibile per la misura da 60 cm.



**WITHOUT SIPHON CUTOUT**  
/ OHNE SIPHON / SENZA SIFONE  
Ref: 432 00 000

# GALSAKY MODULAR

## DRAWER MODULE

SCHUBLADENMODUL / MODULO CASSETTI

Replace X with the handle colour reference:  
Ersetzen Sie X durch die Farbreferenz des Griffs:  
Sostituire X con il riferimento del colore della maniglia:

- Chrome (C)
- Black (N)
- Gold (G)

### GALSAKY 60 (23.62")

Finishes	Reference
● Glossy White	151 01 060 (X)
● Natural Oak	151 24 060 (X)
● Grey Pine	151 37 060 (X)
● Matte Mist	151 71 060 (X)
● Matte Mink	151 74 060 (X)
● Matte Leaf	151 47 060 (X)
● Matte Sunset	151 48 060 (X)
● Matte Island	151 49 060 (X)

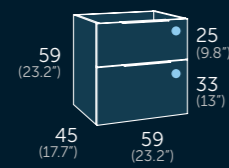

### GALSAKY 70 (27.55")

Finishes	Reference
● Glossy White	151 01 070 (X)
● Natural Oak	151 24 070 (X)
● Grey Pine	151 37 070 (X)
● Matte Mist	151 71 070 (X)
● Matte Mink	151 74 070 (X)
● Matte Leaf	151 47 070 (X)
● Matte Sunset	151 48 070 (X)
● Matte Island	151 49 070 (X)

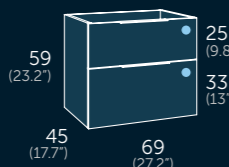

### GALSAKY 80 (31.49")

Finishes	Reference
● Glossy White	151 01 080 (X)
● Natural Oak	151 24 080 (X)
● Grey Pine	151 37 080 (X)
● Matte Mist	151 71 080 (X)
● Matte Mink	151 74 080 (X)
● Matte Leaf	151 47 080 (X)
● Matte Sunset	151 48 080 (X)
● Matte Island	151 49 080 (X)

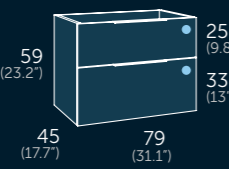

### GALSAKY 90 (35.43")

Finishes	Reference
● Glossy White	151 01 090 (X)
● Natural Oak	151 24 090 (X)
● Grey Pine	151 37 090 (X)
● Matte Mist	151 71 090 (X)
● Matte Mink	151 74 090 (X)
● Matte Leaf	151 47 090 (X)
● Matte Sunset	151 48 090 (X)
● Matte Island	151 49 090 (X)

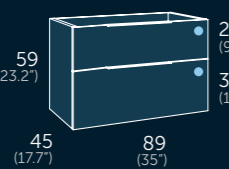

### GALSAKY 100 (39.37")

Finishes	Reference
● Glossy White	151 01 100 (X)
● Natural Oak	151 24 100 (X)
● Grey Pine	151 37 100 (X)
● Matte Mist	151 71 100 (X)
● Matte Mink	151 74 100 (X)
● Matte Leaf	151 47 100 (X)
● Matte Sunset	151 48 100 (X)
● Matte Island	151 49 100 (X)

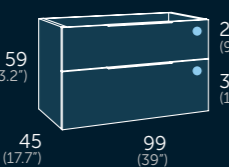

## MODULE DOORS

MODULTÜREN / MODULO CON PORTE

Reversible opening  
Umkehrbare Öffnung  
Apertura reversibile

Replace X with the handle colour reference:  
Ersetzen Sie X durch die Farbreferenz des Griffs:  
Sostituire X con il riferimento del colore della maniglia:

- Chrome (C)
- Black (N)
- Gold (G)

### DOOR 20 (7.87")

Finishes	Reference
● Glossy White	151 01 020 (X)
● Natural Oak	151 24 020 (X)
● Grey Pine	151 37 020 (X)
● Matte Mist	151 71 020 (X)
● Matte Mink	151 74 020 (X)
● Matte Leaf	151 47 020 (X)
● Matte Sunset	151 48 020 (X)
● Matte Island	151 49 020 (X)

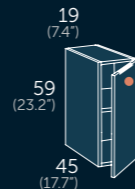

### DOOR 30 (11.81")

Finishes	Reference
● Glossy White	151 01 030 (X)
● Natural Oak	151 24 030 (X)
● Grey Pine	151 37 030 (X)
● Matte Mist	151 71 030 (X)
● Matte Mink	151 74 030 (X)
● Matte Leaf	151 47 030 (X)
● Matte Sunset	151 48 030 (X)
● Matte Island	151 49 030 (X)

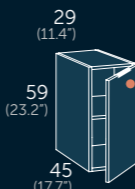

### STRIP / LEISTE / REGGETTA 6-20\* (2.3" - 8")

Finishes	Reference
● Glossy White	151 01 540
● Natural Oak	151 24 540
● Grey Pine	151 37 540
● Matte Mist	151 71 540
● Matte Mink	151 74 540
● Matte Leaf	151 47 540
● Matte Sunset	151 48 540
● Matte Island	151 49 540

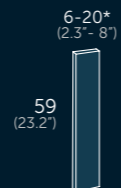

\*Manufactured to the exact centimeter.  
Width: from 6 to 20 cm. Made to order.  
\*Hergestellt auf den genauen Zentimeter.  
Breite: von 6 bis 20 cm. Auf Bestellung gefertigt.  
\*Realizzato al centimetro esatto.  
Larghezza: da 6 a 20 cm. Prodotto su ordinazione.

## COUNTERTOPS / ABDECKUNG / PIANO

cm	Natural Oak	Grey Pine
60	112 24 206	112 37 206
70	112 24 207	112 37 207
80	112 24 208	112 37 208
90	112 24 209	112 37 209
100	112 24 210	112 37 210
110	112 24 211	112 37 211
120	112 24 212	112 37 212
130	112 24 213	112 37 213
140	112 24 214	112 37 214
150	112 24 215	112 37 215
160	112 24 216	112 37 216
180	112 24 218	112 37 218
200	112 24 220	112 37 220
cm linear	112 24 999	112 37 999



The countertops and plinthead countertops are delivered without holes. Easily drillable with a wood carpenter's hole saw.  
Die Arbeitsplatten und erhöhten Arbeitsplatten werden ohne Bohrungen geliefert. Leicht bohrbar mit einer Holzlockkreissäge.  
I piani di lavoro e i piani di lavoro con alzatina vengono consegnati senza fori. Facili da forare con una sega a tazza per legno.

**DRILLING SERVICE**  
Plan required. Ref: 435 00 050

Custom-made production on request up to 200 cm.  
Maßanfertigung auf Anfrage bis zu 200 cm.  
Produzione su misura su richiesta fino a 200 cm.

**REINFORCEMENT BAR**  
VERSTÄRKUNGSSTANGE  
BARRA DI RINFORZO  
ALUMINIUM

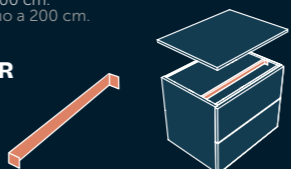

cm	Reference
60	425 14 060
70	425 14 070
80	425 14 080
90	425 14 090
100	425 14 100

⚠ To avoid deformation of the lids, it is necessary to install the reinforcement bar in the module where the basin will be supported.  
Um eine Verformung des Waschtischplatten zu vermeiden, ist es notwendig eine Waschtischplatten-Stabilisierung in dem Modul zu installieren, auf dem das Waschbecken aufliegt.  
Per evitare la deformazione del piano, è necessario installare la barra di rinforzo nel modulo dove il lavabo sarà sostenuto.

## MYTHO COUNTERTOP



CARRARA		MARQUINA STORM		PURE CEMENT	
cm	Reference	cm	Reference	cm	Reference
61	532 76 060	61	532 77 060	61	532 95 060
81	532 76 080	81	532 77 080	81	532 95 080
101	532 76 100	101	532 77 100	101	532 95 100
121	532 76 120	121	532 77 120	121	532 95 120
141	532 76 140	141	532 77 140	141	532 95 140
cm linear	532 76 999	cm linear	532 77 999	cm linear	532 95 999

Custom manufacturing upon request up to 200 cm.  
Maßanfertigung auf Anfrage bis zu 200 cm.  
Produzione su misura su richiesta fino a 200 cm.

⚠ To avoid deformation of the lids, it is necessary to install the reinforcement bar in the module where the basin will be supported.  
Um eine Verformung des Waschtischplatten zu vermeiden, ist es notwendig eine Waschtischplatten-Stabilisierung in dem Modul zu installieren, auf dem das Waschbecken aufliegt.  
Per evitare la deformazione del piano, è necessario installare la barra di rinforzo nel modulo dove il lavabo sarà sostenuto.

**DRILLING SERVICE**  
Plan required. Ref: 435 00 050

## SPECIAL DRAWER / SPEZIALSCHUBLADE / CASSETTO SPECIALE

Check all the information on page XXX. Konsultieren Sie alle Informationen auf Seite XXX.  
Consulta tutte le informazioni nella pagina XXX.

**WITHOUT SIPHON CUTOUT**  
/ OHNE SIPHON / SENZA SIFONE  
Ref: 432 00 000

**OFFSET SIPHON CUTOUT**  
/ VERSCHIEBBARER SIPHON / SIFONE REGOLABILE  
Ref: 432 00 001  
A plan is required. Not available for the 60 cm size.  
Plan erforderlich. Nicht verfügbar für die Größe 60 cm.  
Piano richiesto. Non disponibile per la misura da 60 cm.

## SIDE CABINETS / HÄNGESCHRÄNKE / ARMADI

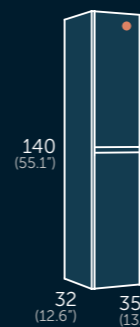

### POKER TALL

Finishes	Reference
● Glossy White	167 01 335 (X)
● Natural Oak	167 24 335 (X)
● Grey Pine	167 37 335 (X)
● Matte Mist	167 71 335 (X)
● Matte Mink	167 74 335 (X)
● Matte Leaf	167 47 335 (X)
● Matte Sunset	167 48 335 (X)
● Matte Island	167 49 335 (X)

Reversible opening | Umkehrbare Öffnung  
| Apertura reversibile

Replace X with the handle colour reference:  
Ersetzen Sie X durch die Farbreferenz des Griffs:  
Sostituire X con il riferimento del colore della maniglia:

- Chrome (C)
- Black (N)
- Gold (G)

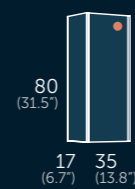

### JOKER MEDIUM

Finishes	Reference
● Glossy White	137 01 435
● Natural Oak	137 24 435
● Grey Pine	137 37 435
● Matte Mist	137 71 435
● Matte Mink	137 74 435
● Matte Leaf	137 47 435
● Matte Sunset	137 48 435
● Matte Island	137 49 435

Reversible opening | Umkehrbare Öffnung  
| Apertura reversibile

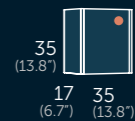

### JOKER SMALL

Finishes	Reference
● Glossy White	137 01 445
● Natural Oak	137 24 445
● Grey Pine	137 37 445
● Matte Mist	137 71 445
● Matte Mink	137 74 445
● Matte Leaf	137 47 445
● Matte Sunset	137 48 445
● Matte Island	137 49 445

Reversible opening | Umkehrbare Öffnung  
| Apertura reversibile

## LEGS / BEINE / GAMBE

Painted iron structure. Lackierte Eisenstruktur. Struttura in ferro verniciato.

### INDUSTRIAL Height 83 cm



#### MATTE BLACK

Reference  
**WITH TOWEL RAIL**  
412 02 752

#### WITHOUT TOWEL RAIL

412 02 750  
(Price per unit)

### KUADRO Height 29.2 cm



#### MATTE BLACK

Reference  
412 02 720  
(2 units)

#### ALUMINIUM

Reference  
412 00 720  
(2 units)

## MIRRORS / SPIEGEL / SPECCHI



**MIRRORS**  
see page XYZ.

**LED MIRRORS**  
see page XYZ.

**MIRROR CABINETS**  
see page XYZ.



# GALSAKY INDUSTRIAL

60 | 70 | 80 | 90 | 100 | 120 | 140

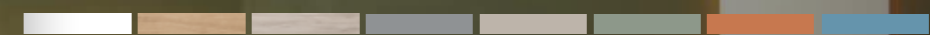



-  Organizer unit.  
Utensilien Behälter.  
Organizzatore.
-  Adjustable front.  
Einstellbare Vorderseite.  
Frontal regulabili.
-  Soft close.  
Soft-close-System.  
Chiusura ammortizzata.
-  Hettich sliding system.  
Korpusschiene Hettich.  
Guide Hettich.
-  Soft close.  
Soft-close-System.  
Chiusura ammortizzata.
-  Glossy lacquered finish.  
Glanzend lackiert.  
Laccato lucido.



FURNITURE

Glossy White	Matte Mink
Natural Oak	Matte Leaf
Grey Pine	Matte Sunset
Matte Mist	Matte Island

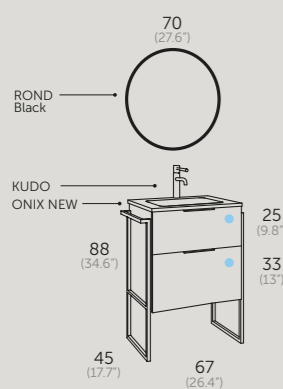

**GALSAKY IND 60**

- 150 01 060 Galsaky IND 60
- 550 01 060 Onix New
- 244 02 070 Rond Black
- 412 02 810 Kudo Black

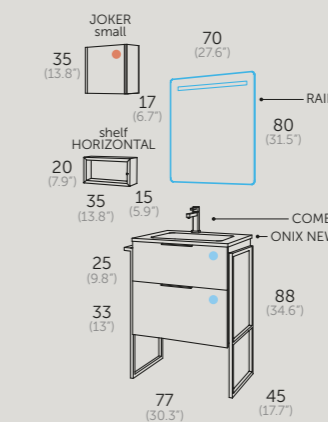



**GALSAKY IND 70**

- 150 49 070 Galsaky IND 70
- 550 01 070 Onix New
- 269 00 070 Rain
- 137 49 445 Joker Small Island / Klein / Piccolo
- 112 35 505 Shelf Horizontal White / Regal Horizontale / Scaffale Orizzontale
- 412 00 801 Combi Black





-  Organizer unit. Utensilien Behälter. Organizzatore.
-  Adjustable front. Einstellbare Vorderseite. Frontali regolabili.
-  Soft close. Soft-close-System. Chiusura ammortizzata.
-  Hettich sliding system. Korpuschiene Hettich. Guide Hettich.
-  Soft close. Soft-close-System. Chiusura ammortizzata.
-  Anti fog system. Anti-Beschlag-System. Sistema antiappannamento.
-  Dual sensor On/Off-anti-fog. Doppelter Sensorschalter. On/Off. Doppio sensore di con tatto. On/Off. Antiappannante.

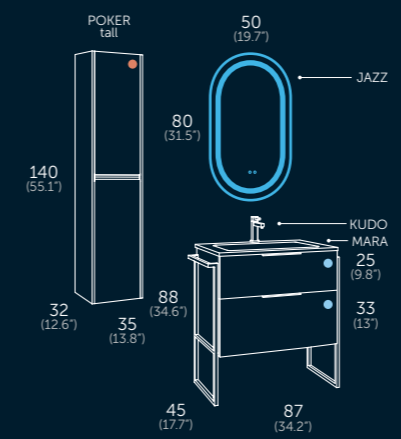

**GALSAKY IND 80**

- 150 47 080 Galsaky IND 80
- 540 05 080 Mara Beige
- 271 02 050 Jazz
- 167 47 335 N Poker Tall Leaf / Hoch / Alto
- 412 02 810 Kudo Black



FURNITURE

Glossy White	Natural Oak	Grey Pine	Matte Mist
Matte Mink	Matte Leaf	Matte Sunset	Matte Island



## GALSAKY IND 100

- 150 71 100 Galsaky IND 100
- 506 01 100 G Ambar  
without tap drilling / Ohne Armaturenloch  
/ senza foro per rubinetto
- 204 00 100 Sun
- 400 02 191 Esther Black 45
- 167 71 335 N Poker Tall Mist / Hoch / Alto
- 412 71 700 Shelf IND Mist / IND Regal / Scaffale IND
- 412 02 808 Combi Wall-Mounted Black

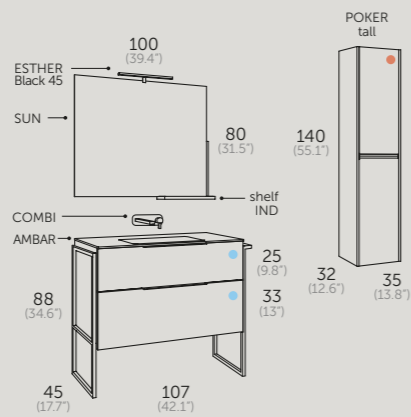

Organizer unit.  
Utensilien Behälter.  
Organizzatori.



Adjustable front.  
Einstellbare Vorderseite.  
Frontali regolabili.



Soft close.  
Soft-close-System.  
Chiusura ammortizzata.



Hettich sliding system.  
Korpusschiene Hettich.  
Guide Hettich.



Soft close.  
Soft-close-System.  
Chiusura ammortizzata.

### FURNITURE

Glossy White	Natural Oak	Grey Pine	Matte Mist
Matte Mink	Matte Leaf	Matte Sunset	Matte Island





## GALSAKY IND 120

- 150 24 120 D Galsaky IND 120  
double towel rail / doppelter handtuchhalter  
/ porta asciugamani doppio
- 112 24 212 Landes Countertop Natural Oak / Abdeckung / Piano  
Reinforcement Bar 60
- 425 14 060 / Waschtischplatte-Stabilisierung 60 / Barra di rinforzo 60
- 580 01 037 Atenas
- 246 00 120 Verona
- 412 02 808 Combi Wall-Mounted Black

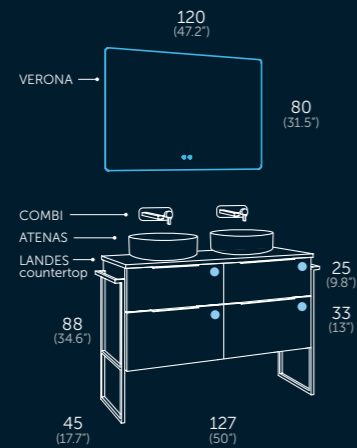

-  Organizer unit. Utensilien Behälter. Organizzatore.
-  Adjustable front. Einstellbare Vorderseite. Frontali regolabili.
-  Soft close. Soft-close-System. Chiusura ammortizzata.
-  Hettich sliding system. Korpuschiene Hettich. Guide Hettich.
-  Soft close. Soft-close-System. Chiusura ammortizzata.
-  Anti fog system. Anti-Beschlag-System. Sistema antiappannamento.
-  Ambient light. Umgebungslicht. Luce ambiente.
-  Intensity control. Intensitätsregler. Regolatore di intensità.
-  Dual sensor On/Off-anti fog. Doppelter Sensorschalter. On/Off. Doppio sensore di con tatto. On/Off. Antiappannante.



## GALSAKY IND 140

- 150 74 140 D Galsaky IND 140  
double towel rail / doppelter handtuchhalter  
/ porta asciugamani doppio
- 506 01 144 Ambar (70+70) Right / Rechts / Destra
- 418 71 000 Siphon Cover / Siphonabdeckung / Coprisifone
- 239 02 100 Soul Black
- 137 74 445 Joker Small Mink / Klein / Piccolo
- 137 74 455 Joker Shelf Mink / Regal / Scaffale
- 412 00 801 Combi Black

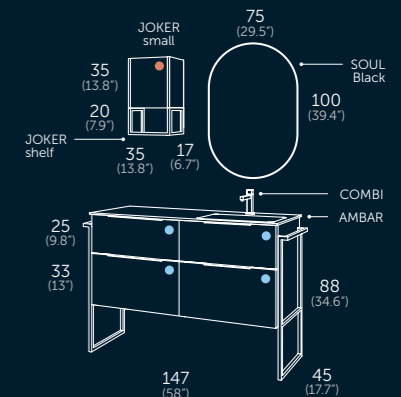

### FURNITURE

Glossy White	Natural Oak	Matte Mink	Matte Mist
Grey Pine	Matte Leaf	Matte Sunset	Matte Island

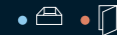

**GALSAKY IND 60** (23.62")

Finishes	Reference
● Glossy White	150 01 060
● Natural Oak	150 24 060
● Grey Pine	150 37 060
● Matte Mist	150 71 060
● Matte Mink	150 74 060
● Matte Leaf	150 47 060
● Matte Sunset	150 48 060
● Matte Island	150 49 060

ONIX NEW ceramic	AMBAR / MARA	ZEN / IRIS
Reference ● Glossy White 550 01 060 ● Matte Colour 552 XX 060	Reference ● Solid Surface 506 01 060 ● Resin Colour 540 XX 060	Reference ● Solid Surface 555 01 060 ● Resin Colour 536 XX 060

SUN	ROND BLACK	RAIN LED	VERONA LED	JAZZ LED
Reference 204 00 060	Reference 244 02 060	Reference 269 00 060	Reference 246 00 060	Reference 271 02 050

**POKER TALL**

Finishes	Reference
● Glossy White	167 01 335 N
● Natural Oak	167 24 335 N
● Grey Pine	167 37 335 N
● Matte Mist	167 71 335 N
● Matte Mink	167 74 335 N
● Matte Leaf	167 47 335 N
● Matte Sunset	167 48 335 N
● Matte Island	167 49 335 N

Reversible opening | Umkehrbare Öffnung | Apertura reversibile

**GALSAKY IND 70** (27.55")

Finishes	Reference
● Glossy White	150 01 070
● Natural Oak	150 24 070
● Grey Pine	150 37 070
● Matte Mist	150 71 070
● Matte Mink	150 74 070
● Matte Leaf	150 47 070
● Matte Sunset	150 48 070
● Matte Island	150 49 070

ONIX NEW ceramic	AMBAR / MARA	ZEN / IRIS
Reference ● Glossy White 550 01 070 ● Matte Colour 552 XX 070	Reference ● Solid Surface 506 01 070 ● Resin Colour 540 XX 070	Reference ● Solid Surface 555 01 070 ● Resin Colour 536 XX 070

SUN	ROND BLACK	VERONA ROND LED	VERONA LED	AURA LED
Reference 204 00 070	Reference 244 02 070	Reference 247 00 070	Reference 246 00 070	Reference 250 02 070

**JOKER MEDIUM**

Finishes	Reference
● Glossy White	137 01 435
● Natural Oak	137 24 435
● Grey Pine	137 37 435
● Matte Mist	137 71 435
● Matte Mink	137 74 435
● Matte Leaf	137 47 435
● Matte Sunset	137 48 435
● Matte Island	137 49 435

Reversible opening | Umkehrbare Öffnung | Apertura reversibile

**GALSAKY IND 80** (31.49")

Finishes	Reference
● Glossy White	150 01 080
● Natural Oak	150 24 080
● Grey Pine	150 37 080
● Matte Mist	150 71 080
● Matte Mink	150 74 080
● Matte Leaf	150 47 080
● Matte Sunset	150 48 080
● Matte Island	150 49 080

ONIX NEW ceramic	AMBAR / MARA	ZEN / IRIS
Reference ● Glossy White 550 01 080 ● Matte Colour 552 XX 080	Reference ● Solid Surface 506 01 080 ● Resin Colour 540 XX 080	Reference ● Solid Surface 555 01 080 ● Resin Colour 536 XX 080

SUN	ROND BLACK	VERONA ROND LED	VERONA LED	AURA LED
Reference 204 00 080	Reference 244 02 080	Reference 247 00 080	Reference 246 00 080	Reference 250 02 080

**JOKER SMALL**

Finishes	Reference
● Glossy White	137 01 445
● Natural Oak	137 24 445
● Grey Pine	137 37 445
● Matte Mist	137 71 445
● Matte Mink	137 74 445
● Matte Leaf	137 47 445
● Matte Sunset	137 48 445
● Matte Island	137 49 445

Reversible opening | Umkehrbare Öffnung | Apertura reversibile

**GALSAKY IND 90** (35.43")

Finishes	Reference
● Glossy White	150 01 090
● Natural Oak	150 24 090
● Grey Pine	150 37 090
● Matte Mist	150 71 090
● Matte Mink	150 74 090
● Matte Leaf	150 47 090
● Matte Sunset	150 48 090
● Matte Island	150 49 090

ONIX NEW ceramic	AMBAR / MARA	ZEN / IRIS
Reference ● Glossy White 550 01 090	Reference ● Solid Surface 506 01 090 ● Resin Colour 540 XX 090	Reference ● Solid Surface 555 01 090 ● Resin Colour 536 XX 090

SUN	ROND	NITRO	TOWER LED
Reference 204 00 090	Reference 244 00 090	Reference 241 00 120	Reference 262 00 120

**SHELF IND**

Finishes	Reference
● Glossy White	412 01 700
● Natural Oak	412 24 700
● Grey Pine	412 37 700
● Matte Mist	412 71 700
● Matte Mink	412 74 700
● Matte Leaf	412 47 700
● Matte Sunset	412 48 700
● Matte Island	412 49 700

Compatible with all SUN mirror sizes. Right-side placement only. Kompatibel mit allen SUN-Spiegelgrößen. Nur auf der rechten Seite platzierbar. Compatible with tutte le dimensioni dello SUN. Posizionamento solo sul lato destro.

**GALSAKY IND 100** (39.37")

Finishes	Reference
● Glossy White	150 01 100
● Natural Oak	150 24 100
● Grey Pine	150 37 100
● Matte Mist	150 71 100
● Matte Mink	150 74 100
● Matte Leaf	150 47 100
● Matte Sunset	150 48 100
● Matte Island	150 49 100

ONIX NEW ceramic	AMBAR / MARA	ZEN / IRIS
Reference ● Glossy White 550 01 100	Reference ● Solid Surface 506 01 100 ● Resin Colour 540 XX 100	Reference ● Solid Surface 555 01 100 ● Resin Colour 536 XX 100

SUN	ROND	NITRO	TOWER LED
Reference 204 00 100	Reference 244 00 100	Reference 241 00 140	Reference 262 00 140

**SPECIAL DRAWER**  
SPEZIALSCHUBLADE / CASSETTO SPECIALE

Check all the information on page 429. Konsultieren Sie alle Informationen auf Seite 429. Consulta tutte le informazioni nella pagina 429.

**OFFSET SIPHON CUTOUT**  
/ VERSCHIEBBARER SIPHON / SIFONE REGOLABILE  
Ref: 432 00 001  
A plan is required. Not available for the 60 cm size. Plan erforderlich. Nicht verfügbar für die Größe 60 cm. Piano richiesto. Non disponibile per la misura da 60 cm.

**WITHOUT SIPHON CUTOUT**  
/ OHNE SIPHON / SENZA SIFONE  
Ref: 432 00 000

**GALSAKY IND 120** (47.24")

Finishes	Reference
● Glossy White	150 01 120
● Natural Oak	150 24 120
● Grey Pine	150 37 120
● Matte Mist	150 71 120
● Matte Mink	150 74 120
● Matte Leaf	150 47 120
● Matte Sunset	150 48 120
● Matte Island	150 49 120

ONIX NEW ceramic	AMBAR / MARA	ZEN / IRIS
Reference ● Glossy White 550 01 122	Reference ● Solid Surface 506 01 122 ● Resin Colour 540 XX 122	Reference ● Solid Surface 555 01 122 ● Resin Colour 536 XX 122

Replace the XX by the chosen colour code. See codes on page 447. Ersetzen Sie XX durch den Code der ausgewählten Farbe. Siehe Seite 447 für Farbcodes. Sostituire l'XX con il codice colore scelto. Vedere i codici a pagina 447.

**GALSAKY IND 140** (55.12")

Finishes	Reference
● Glossy White	150 01 140
● Natural Oak	150 24 140
● Grey Pine	150 37 140
● Matte Mist	150 71 140
● Matte Mink	150 74 140
● Matte Leaf	150 47 140
● Matte Sunset	150 48 140
● Matte Island	150 49 140

AMBAR / MARA
Reference ● Solid Surface 506 01 142 ● Resin Colour 540 XX 142

**TOWEL RAIL OPTIONS**  
HANDTUCHHALTER-OPTIONEN / OPZIONI PORTA ASCIUGAMANI

Option structure without towel rail. Add the letter "S" at the end of the reference. Option: Struktur ohne Handtuchhalter. Fügen Sie den Buchstaben "S" am Ende der Referenz hinzu. Opzione: struttura senza porta asciugamani. Aggiungere la lettera "S" alla fine della referenza.

Option structure with 2 towel rails. Add the letter "D" at the end of the reference. Option: Struktur mit 2 Handtuchhaltern. Fügen Sie den Buchstaben "D" am Ende der Referenz hinzu. Opzione: struttura con 2 porta asciugamani. Aggiungere la lettera "D" alla fine della referenza.

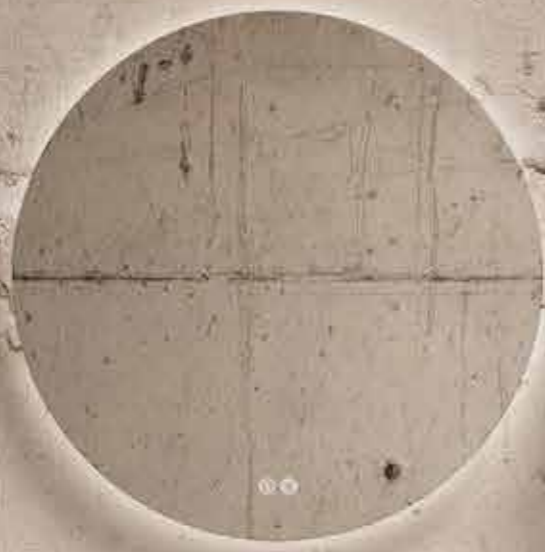

# AVANT

80 | 100

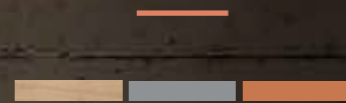

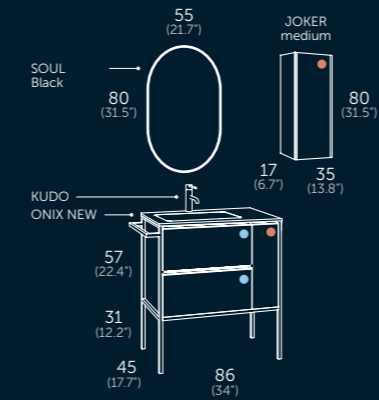

### AVANT 80

- 147 24 080 Avant 80
- 550 01 081 Onix New (60+20) Left / Links / Sinistra
- 239 02 080 Soul Black
- 137 24 435 Joker Medium Natural Oak / Mittel / Medio
- 412 02 810 Kudo Black

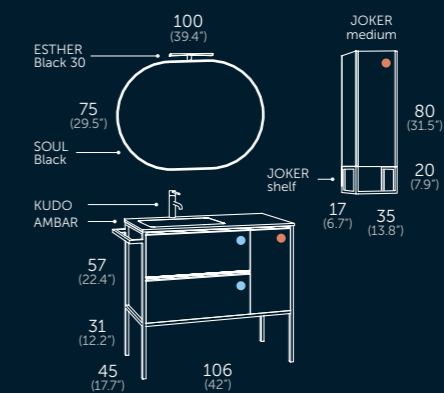



### AVANT 100

- 147 48 100 Avant 100
- 506 01 107 Ambar (70+30) Left / Links / Sinistra
- 239 02 100 Soul Black
- 400 02 121 Esther Black 30
- 137 48 435 Joker Medium Sunset / Mittel / Medio
- 137 48 455 Joker Shelf Sunset / Regal / Scaffale
- 412 02 810 Kudo Black



 Organizer unit. Utensilien Behälter. Organizzatore.

 Adjustable front. Einstellbare Vorderseite. Frontali regolabili.

 Soft close. Soft-close-System. Chiusura ammortizzata.

 Hettich sliding system. Korpuschiene Hettich. Guide Hettich.

 Soft close. Soft-close-System. Chiusura ammortizzata.

#### STRUCTURE

- Matte Black
- Matte Gold

#### FURNITURE

- Natural Oak
- Matte Mist
- Matte Sunset



-  Organizer unit.  
Utensilien Behälter.  
Organizzatore.
-  Adjustable front.  
Einstellbare Vorderseite.  
Frontali regolabili.
-  Soft close.  
Soft-close-System.  
Chiusura ammortizzata.
-  Hettich sliding system.  
Korpusschiene Hettich.  
Guide Hettich.
-  Soft close.  
Soft-close-System.  
Chiusura ammortizzata.

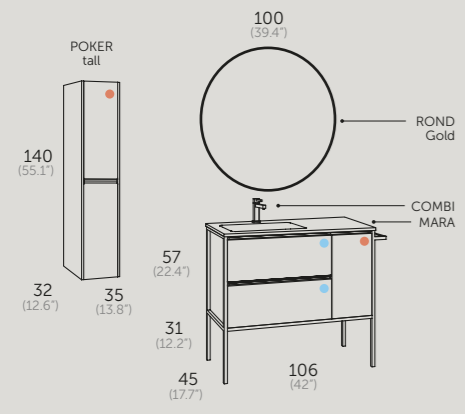

**AVANT 100**

- 149 71 100 Avant 100
- 540 22 101 Mara Mist (70+30) Left / Links / Sinistra
- 244 72 100 Rond Gold
- 167 71 335 G Poker Tall Mist / Hoch / Alto
- 412 00 802 Combi Gold



- STRUCTURE**
- Matte Black
  - Matte Gold
- FURNITURE**
- Natural Oak
  - Matte Mist
  - Matte Sunset



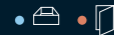

### AVANT 80 (31.49")

**MATTE BLACK**  
Finishes Reference

- Natural Oak 147 24 080
- Matte Mist 147 71 080
- Matte Sunset 147 48 080

**MATTE GOLD**  
Finishes Reference

- Natural Oak 149 24 080
- Matte Mist 149 71 080
- Matte Sunset 149 48 080

### AVANT 100 (39.37")

**MATTE BLACK**  
Finishes Reference

- Natural Oak 147 24 100
- Matte Mist 147 71 100
- Matte Sunset 147 48 100

**MATTE GOLD**  
Finishes Reference

- Natural Oak 149 24 100
- Matte Mist 149 71 100
- Matte Sunset 149 48 100

#### TOWEL RAIL OPTIONS / OPTIONEN FÜR HANDTUCHHALTER / OPZIONI PORTASCIUGAMANI

**Structure option without towel rail:**  
Add the letter "S" at the end of the reference.  
**Structure option with 2 towel rails:**  
Add the letter "D" at the end of the reference.

**Option ohne Handtuchhalter:**  
Fügen Sie den Buchstaben "S" am Ende der Referenz hinzu.  
**Option mit 2 Handtuchhaltern:**  
Fügen Sie den Buchstaben "D" am Ende der Referenz hinzu.

**Opzione struttura senza portasciugamani:**  
Aggiungere la lettera "S" alla fine del riferimento.  
**Opzione struttura con 2 portasciugamani:**  
Aggiungere la lettera "D" alla fine del riferimento.

#### SPECIAL DRAWER SPEZIALSCHUBLADE / CASSETTO SPECIALE

Check all the information on page 429.  
Konsultieren Sie alle Informationen auf Seite 429.  
Consulta tutte le informazioni nella pagina 429.

**WITHOUT SIPHON CUTOUT**  
OHNE SIPHON / SENZA SIFONE  
Ref: 432 00 000

**ONIX NEW ceramic**  
Reference

- Glossy White 550 01 081
- Matte Colour 552 XX 081

**AMBAR / MARA**  
Reference

- Solid Surface 506 01 081
- Resin Colour 540 XX 081

**ONIX NEW ceramic**  
Reference

- Glossy White 550 01 101

**AMBAR / MARA**  
Reference

- Solid Surface 506 01 107
- Resin Colour 540 XX 101

**COMBI tap**  
Reference

- Black 412 00 801
- Gold 412 00 802
- Full Color 412 XX 803

**KUDO tap**  
Reference

- Black 412 02 810
- Brushed Gold 412 03 810
- Full Color 412 XX 811

**WALL-MOUNTED tap**  
Reference

- Black 412 02 808
- Gold 412 03 808

**DRAIN clic clac**  
Reference

- Black 410 02 203
- White 410 01 203
- Brushed Gold 410 03 203
- Colour 409 XX 203

Replace the **XX** by the chosen colour code. See codes on page 447.  
Ersetzen Sie **XX** durch den Code der ausgewählten Farbe. Siehe Seite 447 für Farbcodes.  
Sostituire l'**XX** con il codice colore scelto. Vedere i codici a pagina 447.

**NITRO**  
Reference 241 00 080

**ROND**  
Reference 244 02 080  
● BLACK  
● GOLD 244 72 080

**RAIN LED**  
Reference 269 00 080

**VERONA ROND LED**  
Reference 247 00 080

**COSMOS LED**  
Reference 270 00 080

**AURA LED**  
Reference 250 02 080

**VERONA LED**  
Reference 246 00 080

**SPOTY LED**  
Reference 267 00 080

**NITRO**  
Reference 241 00 100

**ROND**  
Reference 244 02 100  
● BLACK  
● GOLD 244 72 100

**RAIN LED**  
Reference 269 00 100

**VERONA ROND LED**  
Reference 247 00 100

**COSMOS LED**  
Reference 270 00 100

**AURA LED**  
Reference 250 02 100

**VERONA LED**  
Reference 246 00 100

**SPOTY LED**  
Reference 267 00 100

**SOUL**  
Reference 239 02 090  
● BLACK  
● GOLD 239 72 090

**SOUL**  
Reference 239 02 080  
● BLACK  
● GOLD 239 72 080

**SOUL**  
Reference 239 02 100  
● BLACK  
● GOLD 239 72 100

**AURA STRAP LED**  
Reference 251 02 060

**AURA STRAP LED**  
Reference 251 02 070

**ESTHER BLACK 30**  
Reference 400 02 141

**ESTHER BLACK 45**  
Reference 400 02 191

**POKER TALL**  
Finishes Reference

- Natural Oak 167 24 335 (X)
- Matte Mist 167 71 335 (X)
- Matte Sunset 167 48 335 (X)

Replace the X with the handle reference:  
Ersetzen Sie das X durch die Griffreferenz:  
Sostituire la X con il riferimento della maniglia.

● Black (N) ● Gold (G)

Reversible opening | Umkehrbare Öffnung  
| Apertura reversibile

**JOKER MEDIUM**  
Finishes Reference

- Natural Oak 137 24 435
- Matte Mist 137 71 435
- Matte Sunset 137 48 435

Reversible opening | Umkehrbare Öffnung  
| Apertura reversibile

**JOKER SMALL**  
Finishes Reference

- Natural Oak 137 24 445
- Matte Mist 137 71 445
- Matte Sunset 137 48 445

Reversible opening | Umkehrbare Öffnung  
| Apertura reversibile

**JOKER SHELF**  
Finishes Reference

- Natural Oak 137 24 455
- Matte Mist 137 71 455
- Matte Sunset 137 48 455

Only for Joker Medium y and Joker Small.  
Nur für Joker Medium und Joker Klein.  
Solo per Joker Medium e Joker Piccolo.

**SHELF IND**  
Finishes Reference

- Natural Oak 412 24 700
- Matte Mist 412 71 700
- Matte Sunset 412 48 700

Compatible with all SUN mirror sizes.  
Right location only.  
Kompatibel mit allen Größen des Spiegels  
SUN. Nur an der richtigen Stelle.  
Compatibile con tutte le dimensioni degli  
specchi SUN. Posizione solo a destra.



# KIRK | SPOK

60 | 70 | 80 | 100

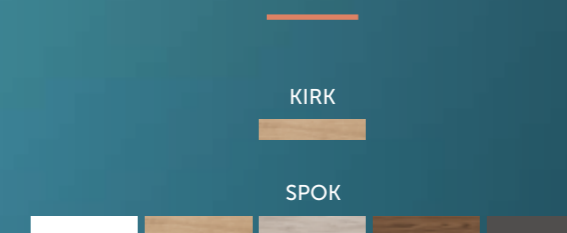

KIRK



SPOK



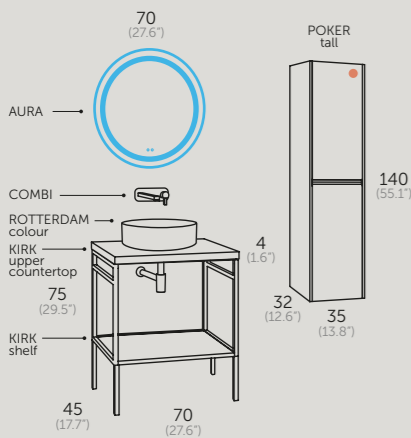

### KIRK 70

FLOOR-STANDING  
BODENSTEHEND  
A TERRA

- 166 02 071 Kirk Floor-Standing 70 / Bodenstehend / A terra
- 166 24 207 Kirk Upper Countertop / Obere Arbeitsplatte / Piano Superiore
- 166 24 507 Kirk Lower Shelf / Unteres Regal / Ripiano inferiore
- 410 02 101 Black Siphon / Siphon / Sifone
- 535 73 004 Rotterdam Colour Garden
- 250 02 070 Aura
- 167 24 335 N Poker Tall Natural Oak / Hoch / Alto
- 412 02 808 Combi Wall-Mounted Black

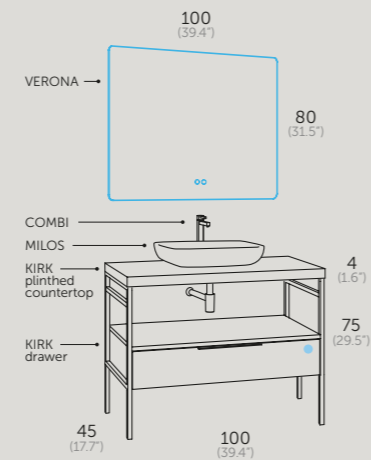

### KIRK 100

FLOOR-STANDING  
BODENSTEHEND  
A TERRA

- 166 02 101 Kirk Floor-Standing 100 / Bodenstehend / A terra
- 166 24 210 Kirk Plinthed Countertop / Obere Waschtischplatte / Piano Superiore
- 166 24 104 Kirk Lower Drawer / Untere Schublade / Casseto inferiore
- 410 02 101 Black Siphon / Siphon / Sifone
- 509 01 052 Milos
- 246 00 100 Verona
- 412 00 806 Combi Tall Black / Hoch / Alto

-  Metal interior drawers.  
Metallzierleiste.  
Sistema di estrazione metallico.
-  Total extraction.  
Vollauszug.  
Estrazione totale.
-  Soft close.  
Soft-close-System.  
Chiusura ammortizzata.
-  GRASS  
Grass sliding system.  
Korpusschiene Grass.  
Guide Grass.
-  Soft close.  
Soft-close-System.  
Chiusura ammortizzata.
-  Anti fog system.  
Anti-Beschlag-System.  
Sistema antiappannamento.
-  Ambient light.  
Umgebungslicht.  
Luce ambiente.
-  Intensity control.  
Intensitätsregler.  
Regolatore di intensità.
-  Dual sensor On/Off-anti fog.  
Doppelter Sensorschalter. On/Off.  
Doppio sensore touch. On/Off.  
Antiappannante.



STRUCTURE Matte Black FURNITURE Natural Oak



## KIRK 60

- 166 02 060 Kirk 60
- 166 24 206 Kirk Upper Countertop / Obere Arbeitsplatte / Piano Superiore
- 166 24 506 Kirk Lower Shelf / Unteres Regal / Ripiano Inferiore
- 410 02 101 Black Siphon / Siphon / Sifone
- 530 01 002 Due
- 239 02 080 Soul Black
- 112 24 435 Landes Medium Natural Oak / Mittel / Medio
- 112 35 505 Shelf Horizontal White / Horizontales Regal / Scaffale Orizzontale
- 412 02 808 Combi Wall-Mounted Black

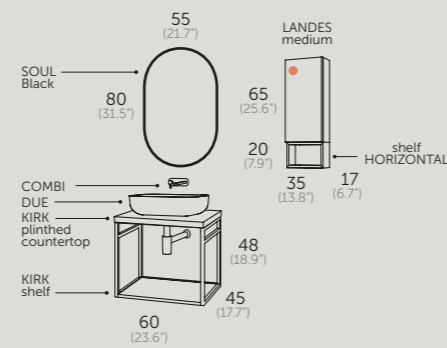

- Metal interior drawers. Metallzierleiste. Sistema di estrazione metallico.
- Total extraction. Vollauszug. Estrazione totale.
- Soft close. Soft-close-System. Chiusura ammortizzata.
- GRASS Grass sliding system. Korpussschiene Grass. Guide Grass.
- Soft close. Soft-close-System. Chiusura ammortizzata.
- Push to open. Push-to-open-System. Sistema Push.

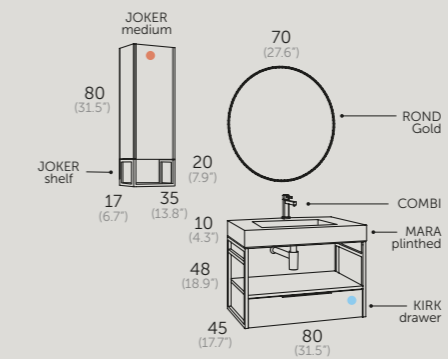

## KIRK 80

- 166 02 080 Kirk 80
- 166 24 084 Kirk Lower Drawer / Untere Schublade / Cassetto Inferiore
- 541 73 080 Mara Plinthead Garden / Wandbecken / Lavabo con gonna
- 410 03 101 Gold Siphon / Siphon / Sifone
- 244 72 070 Rond Gold
- 137 24 435 Joker Medium Natural Oak / Mittel / Medio
- 137 24 455 Joker Shelf Natural Oak / Regal / Scaffale
- 412 00 802 Combi Gold







STRUCTURE

FURNITURE

Matte Black

Natural Oak



-  Metal interior drawers. Metallzierleiste. Sistema di estrazione metallico.
-  Total extraction. Vollauszug. Estrazione totale.
-  Soft close. Soft-close-System. Chiusura ammortizzata.
-  GRASS  
Grass sliding system. Korpussschiene. Grass. Guide Grass.
-  Soft close. Soft-close-System. Chiusura ammortizzata.

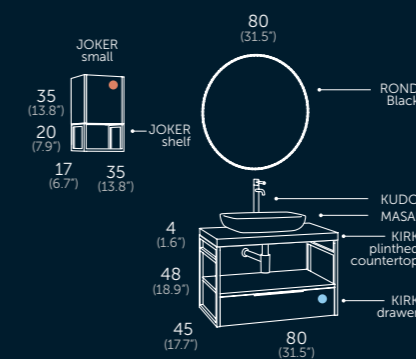

### KIRK 80

- 166 02 080 Kirk 80
- 166 24 208 Kirk Upper Countertop / Obere Arbeitsplatte / Piano Superiore
- 166 24 084 Kirk Lower Drawer / Untere Schublade / Cassetto Inferiore
- 518 02 051 Masai Black
- 410 02 101 Black Siphon / Siphon / Sifone
- 244 02 080 Rond Black
- 137 24 445 Joker Small Natural Oak / Klein / Piccolo
- 137 24 455 Joker Shelf Natural Oak / Regal / Scaffale
- 412 02 815 Kudo Tall Black / Hoch / Alto



STRUCTURE	FURNITURE
Matte Black	Natural Oak



Soft close.  
Soft-close-System.  
Chiusura ammortizzata.

## SPOK 70

- 165 24 070 Spok 70
- 138 24 070 Flow 70
- 410 02 101 Black Siphon / Siphon / Sifone
- 530 01 094 Nove 41
- 244 02 070 Rond Black
- 137 24 445 Joker Small Natural Oak / Klein / Piccolo
- 137 24 455 Joker Shelf Natural Oak / Regal / Scaffale
- 416 02 037 Towel Rail Adhesive 3M Black / Klebehandtuchhalter 3M / Portasciugamani adesivo 3M
- 412 00 801 Combi Black

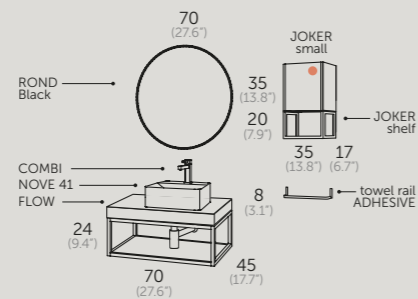

### STRUCTURE

### FURNITURE

- Matte Black
- Matte White
- Natural Oak
- Grey Pine
- Walnut Vera
- Matte Anthracite



Metal interior drawers. Metallzierleiste.  
Sistema di estrazione metallico.



Total extraction. Vollauszug.  
Estrazione totale.



Soft close. Soft-close-System.  
Chiusura ammortizzata.



Grass sliding system. Korpussschiene  
Grass. Guide Grass.

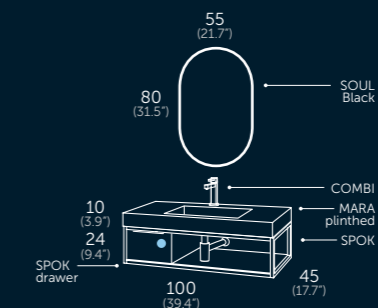

## SPOK 100

- 165 45 100 Spok 100
- 410 02 101 Black Siphon / Siphon / Sifone
- 165 45 033 Spok Drawer Anthracite / Scublade / Cassetto
- 541 19 100 Mara Plinthed Mink / Wandbecken / Lavabo con gonna
- 239 02 080 Soul Black
- 412 00 801 Combi Black



**WALL-MOUNTED STRUCTURE - FLOOR-STANDING / WANDMONTIERTE STRUKTUR - BODENSTEHEND / STRUTTURA A PARETE - A TERRA**

Iron structure painted in Matte Black / Eisenstruktur in Matt-Schwarz lackiert / Struttura in ferro verniciata in nero opaco

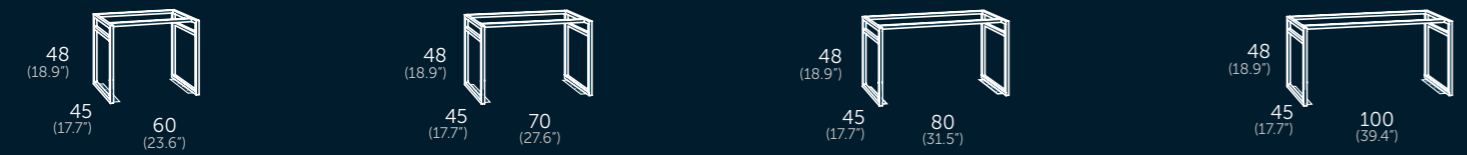

**KIRK 60** (23.62")

Reference  
166 02 060

**KIRK 70** (27.55")

Reference  
166 02 070

**KIRK 80** (31.49")

Reference  
166 02 080

**KIRK 100** (39.37")

Reference  
166 02 100

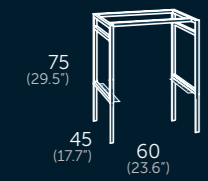

**KIRK 60** (23.62")  
FLOOR-STANDING

Reference  
166 02 061

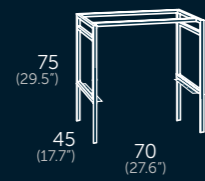

**KIRK 70** (27.55")  
FLOOR-STANDING

Reference  
166 02 071

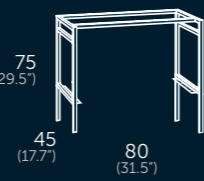

**KIRK 80** (31.49")  
FLOOR-STANDING

Reference  
166 02 081

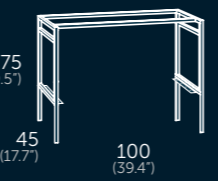

**KIRK 100** (39.37")  
FLOOR-STANDING

Reference  
166 02 101

**ACCESSORIES / ZUBEHÖR / COMPLEMENTI**

**UPPER 4 CM COUNTERTOP**

cm	Reference
60	166 24 206
70	166 24 207
80	166 24 208
100	166 24 210

**LOWER DRAWER**

cm	Reference
60	166 24 064
70	166 24 074
80	166 24 084
100	166 24 104

**LOWER SHELF**

cm	Reference
60	166 24 506
70	166 24 507
80	166 24 508
100	166 24 510

**STRUCTURE + LOWER SHELF / STRUKTUR + UNTERES REGAL / STRUTTURA + RIPIANO INFERIORE**

Iron structure painted in Matte Black / Eisenstruktur in Matt-Schwarz lackiert / Struttura in ferro verniciata in nero opaco

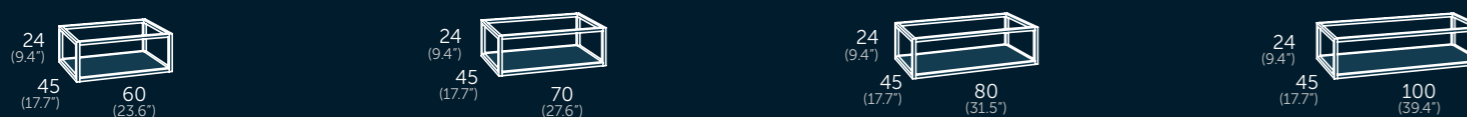

**SPOK 60** (23.62")

Finishes	Reference
● Matte White	165 35 060
● Natural Oak	165 24 060
● Grey Pine	165 37 060
● Walnut Vera	165 84 060
● Matte Anthracite	165 45 060

**SPOK 70** (27.55")

Finishes	Reference
● Matte White	165 35 070
● Natural Oak	165 24 070
● Grey Pine	165 37 070
● Walnut Vera	165 84 070
● Matte Anthracite	165 45 070

**SPOK 80** (31.49")

Finishes	Reference
● Matte White	165 35 080
● Natural Oak	165 24 080
● Grey Pine	165 37 080
● Walnut Vera	165 84 080
● Matte Anthracite	165 45 080

**SPOK 100** (39.37")

Finishes	Reference
● Matte White	165 35 100
● Natural Oak	165 24 100
● Grey Pine	165 37 100
● Walnut Vera	165 84 100
● Matte Anthracite	165 45 100

**ACCESSORY / ZUBEHÖR / COMPLEMENTI**

**SPOK DRAWER 30** (11.8")

Finishes	Reference
● Matte White	165 35 033
● Natural Oak	165 24 033
● Grey Pine	165 37 033
● Walnut Vera	165 84 033
● Matte Anthracite	165 45 033

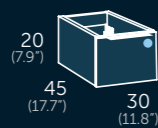

Not compatible with Spok structure in 60 and 70 cm.  
Nicht kompatibel mit der Spok-Struktur in 60 und 70 cm.  
Non compatibile con la struttura Spok da 60 e 70 cm.

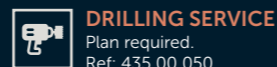

Replace the XX by the chosen colour code. See codes on page 447.  
Ersetzen Sie XX durch den Code der ausgewählten Farbe. Siehe Seite 447 für Farbcodes.  
Sostituire l'XX con il codice colore scelto. Vedere i codici a pagina 447.

**plinthed countertops and washbasins / Arbeitsplatte und Wandbecken / top con gonna e lavabo**

**mirrors / Spiegel / specchi**

MORE OPTIONS SEE PAGES 327-434

**60 cm** (23.62")

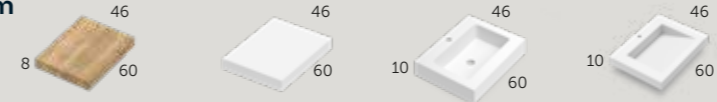

Reference	Reference	Reference	Reference
● Natural Oak 138 24 060	● Solid Surface 525 01 060	● Solid Surface 524 01 060	● Solid Surface 556 01 060
● Matte Mink 138 74 060	● Resin Colour 541 XX 060	● Resin Colour 541 XX 060	● Resin Colour 537 XX 060

**70 cm** (27.55")

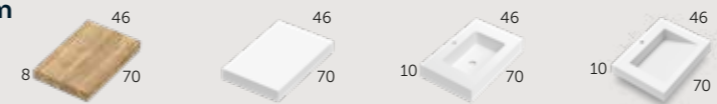

Reference	Reference	Reference	Reference
● Natural Oak 138 24 070	● Solid Surface 525 01 070	● Solid Surface 524 01 070	● Solid Surface 556 01 070
● Matte Mink 138 74 070	● Resin Colour 541 XX 070	● Resin Colour 541 XX 070	● Resin Colour 537 XX 070

**80 cm** (31.49")



Reference	Reference	Reference	Reference
● Natural Oak 138 24 080	● Solid Surface 525 01 080	● Solid Surface 524 01 080	● Solid Surface 556 01 080
● Matte Mink 138 74 080	● Resin Colour 541 XX 080	● Resin Colour 541 XX 080	● Resin Colour 537 XX 080

**100 cm** (39.37")



Reference	Reference	Reference	Reference
● Natural Oak 138 24 100	● Solid Surface 525 01 100	● Solid Surface 524 01 100	● Solid Surface 556 01 100
● Matte Mink 138 74 100	● Resin Colour 541 XX 100	● Resin Colour 541 XX 100	● Resin Colour 537 XX 100

**countertop washbasins / Aufsatzwaschbecken / lavabi da appoggio**



Reference	Reference	Reference	Reference
● Glossy White 507 01 004	● Glossy White 530 01 006	● Solid Surface 584 01 034	● Solid Surface 559 01 050
● Matte Colour 535 XX 004		● Resin Colour 585 XX 034	● Resin Colour 586 XX 049

**accessories / Zubehör / complementi**



Reference	Reference	Reference	Reference
● Black 412 00 801	● Black 412 02 815	● Black 410 02 203	● Black 410 02 101
● Gold 412 00 802	● Brushed Gold 412 03 815	● Brushed Gold 410 03 203	● Brushed Gold 410 03 101
● Full Color 412 XX 803	● Full Color 412 XX 816	● Colour 409 XX 203	



Reference	Reference	Reference
● BLACK 244 02 060	246 00 060	251 02 060
● GOLD 244 72 060		

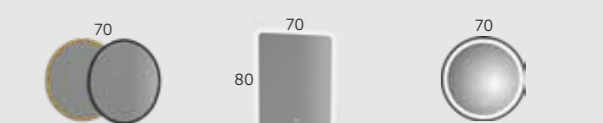

Reference	Reference	Reference
● BLACK 244 02 070	246 00 070	250 02 070
● GOLD 244 72 070		



Reference	Reference	Reference
● BLACK 244 02 080	246 00 080	250 02 080
● GOLD 244 72 080		

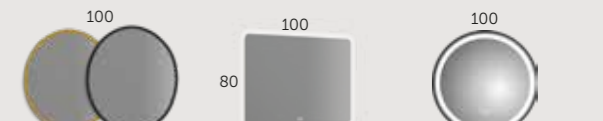

Reference	Reference	Reference
● BLACK 244 02 100	246 00 100	250 02 100
● GOLD 244 72 100		

**side cabinets / Hängeschränke / armadi**

**POKER TALL**

Finishes	Reference
● Natural Oak	167 24 335 N
● Grey Pine	167 37 335 N

**JOKER MEDIUM**

Finishes	Reference
● Natural Oak	137 24 435
● Grey Pine	137 37 435

**JOKER SMALL**

Finishes	Reference
● Natural Oak	137 24 445
● Grey Pine	137 37 445

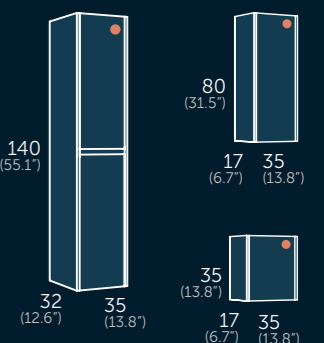



# NUBIA

60 | 80 | 100



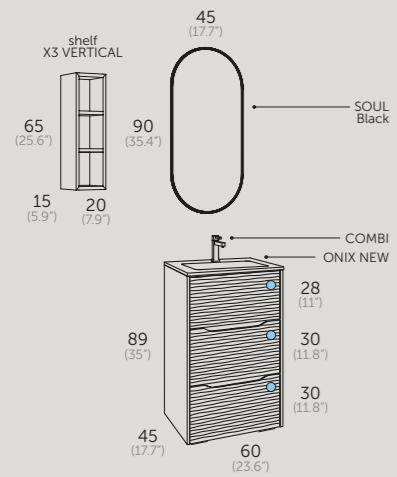





## NUBIA 60

119 73 73 060 Nubia 60 Garden  
 550 01 060 Onix New  
 239 02 090 Soul Black  
 112 47 500 Shelf X3 Vertical Leaf / Regal Vertikal X3 / Scaffale X3 Verticale  
 412 00 801 Combi Black



-  Metal interior drawers.  
Metallzierleiste.  
Sistema di estrazione metallico.
-  Organizer unit.  
Utensilien Behälter.  
Organizzatore.
-  Soft close.  
Soft-close-System.  
Chiusura ammortizzata.
-  GRASS  
Grass sliding system.  
Körpuschiene Grass.  
Guide Grass.
-  Matte lacquered finish.  
Matt lackiert.  
Laccato opaco.

### SIDES

Natural Oak

### SIDES AND FRONTS

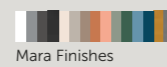

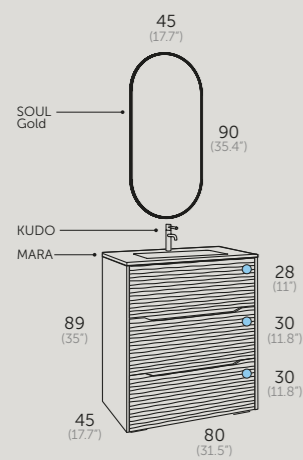

## NUBIA 80

- 119 02 02 080 Nubia 80 Black
- 540 02 080 Mara Black
- 239 72 090 Soul Gold
- 412 03 810 Kudo Brushed Gold / Gebürstet / Spazzolato



### SIDES

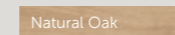

### SIDES AND FRONTS



Mara Finishes

- Metal interior drawers. Metallzierleiste. Sistema di estrazione metallico.
- Organizer unit. Utensilien Behälter. Organizzatore.
- Soft close. Soft-close-System. Chiusura ammortizzata.
- GRASS Grass sliding system. Korpussschiene Grass. Guide Grass.
- Soft close. Soft-close-System. Chiusura ammortizzata.
- Matte lacquered finish. Matt lackiert. Laccato opaco.
- Anti fog system. Anti-Beschlag-System. Sistema antiappannamento.
- Dual sensor On/Off-anti fog. Doppelter Sensorschalter. On/Off. Doppio sensore di con tatto. On/Off. Antiappannante.

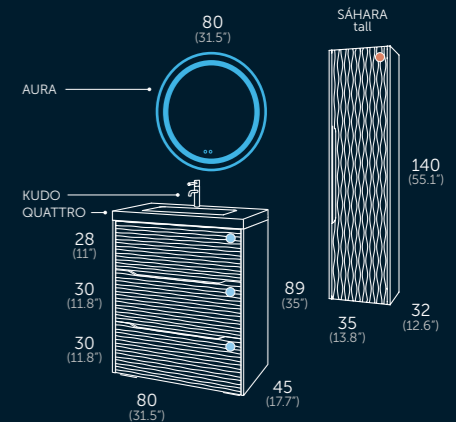







## NUBIA 80

- 119 10 10 080 Nubia 80 Blue Space
- 522 01 080 Quattro
- 250 02 080 Aura
- 120 10 10 335 Sahara Tall Blue Space / Hoch / Alto
- 412 02 810 Kudo Black





-  Metal interior drawers.  
Metallzierleiste.  
Sistema di estrazione metallico.
-  Organizer unit.  
Utensilien Behälter.  
Organizzatore.
-  Soft close.  
Soft-close-System.  
Chiusura ammortizzata.
-  GRASS  
Grass sliding system.  
Korpusschiene Grass.  
Guide Grass.
-  Matte lacquered finish.  
Matt lackiert.  
Laccato opaco.
-  Anti fog system.  
Anti-Beschlag-System.  
Sistema antiappannamento.
-  Dual sensor On/Off-anti fog.  
Doppeller Sensorschalter. On/Off.  
Doppio sensore touch. On/Off.  
Antiappannante.





- SIDES
-  Natural Oak
- SIDES AND FRONTS
-  Mara Finishes

## NUBIA 80

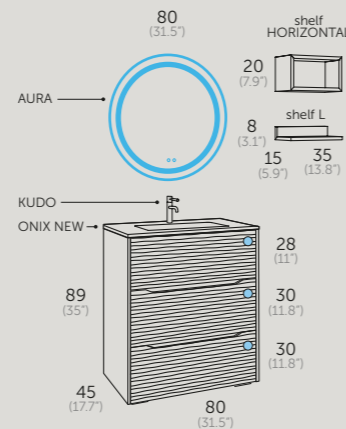
- 119 24 25 080 Nubia 80 Natural Oak + Leaf
- 550 01 080 Onix New
- 405 01 000 Overflow Cover Glossy White
- 250 02 080 Aura
- 112 24 505 Shelf Horizontal Natural Oak / Horizontales Regal / Scaffale Orizzontale
- 112 47 520 Shelf L Leaf / Regal L / Scaffale L
- 412 02 810 Kudo Black





-  Organizer unit.  
Utensilien Behälter.  
Organizzatore.
-  Metal interior drawers.  
Metallzieleiste.  
Sistema di estrazione metallico.
-  Soft close.  
Soft-close-System.  
Chiusura ammortizzata.
-  GRASS  
Grass sliding system.  
Korpusschiene Grass.  
Guide Grass.
-  Soft close.  
Soft-close-System.  
Chiusura ammortizzata.
-  Matte lacquered finish.  
Matt lackiert.  
Laccolato opaco.
-  Anti fog system.  
Anti-Beschlag-System.  
Sistema antiappannamento.
-  Ambient light.  
Umgebungslicht.  
Luce ambiente.
-  Intensity control.  
Intensitätsregler.  
Regolatore di intensità.
-  Dual sensor On/Off-anti fog.  
Doppelter Sensorschalter On/Off.  
Doppio sensore touch. On/Off.  
Antiappannante.



## NUBIA 80

- 119 22 22 080 Nubia 80 Mist
- 540 03 080 Mara Anthracite
- 246 00 080 Verona
- 112 35 505 Shelf Horizontal White / Horizontales Regal / Scaffale Orizzontale
- 112 45 520 Shelf L Anthracite / Regal L / Scaffale L
- 412 02 810 Kudo Black

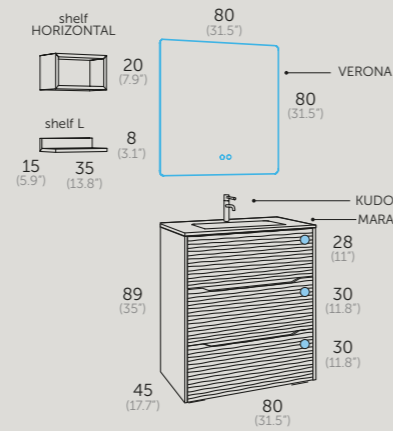

### SIDES

Natural Oak

### SIDES AND FRONTS

Mara Finishes

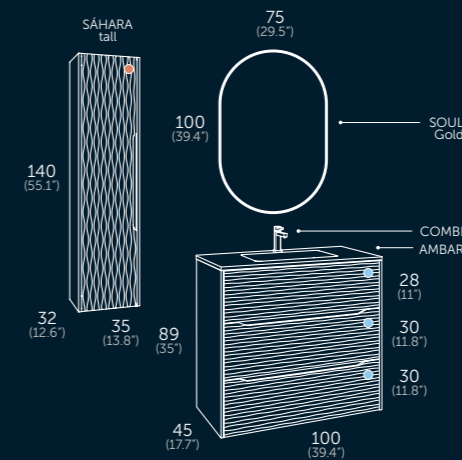

## NUBIA 100

- 119 24 06 100 Nubia 100 Natural Oak + White
- 506 01 100 Ambar
- 239 72 100 Soul Gold
- 120 24 06 335 Sáhara Tall Natural Oak + White / Hoch / Alto
- 412 00 802 Combi Gold



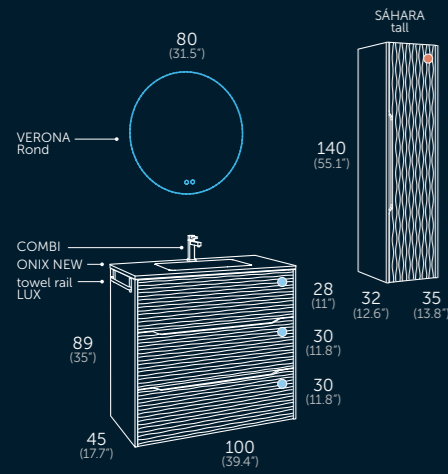

## NUBIA 100

- 119 02 19 100 Nubia 100 Black + Mink
- 550 01 100 Onix New
- 247 00 100 Verona Rond
- 120 02 19 335 Sáhara Tall Black + Mink / Hoch / Alto
- 417 27 001 Lux Towel rail 38 White / Handtuchhalter / Porta Asciugamani
- 412 02 810 Kudo Black

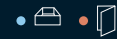

-  Metal interior drawers. Metallzierleiste.  
Sistema di estrazione metallico.
-  Organizer unit. Utensilien Behälter.  
Organizzatore.
-  Soft close. Soft-close-System.  
Chiusura ammortizzata.
-  GRASS Grass sliding system. Korpusschiene  
Grass. Guide Grass.
-  Soft close. Soft-close-System.  
Chiusura ammortizzata.
-  Matte lacquered finish. Matt lackiert.  
Lacato opaco.
-  Anti fog system. Anti-Beschlag-System.  
Sistema antiappannamento.
-  Ambient light. Umgebungslicht.  
Luce ambiente.
-  Intensity control. Intensitätsregler.  
Regolatore di intensità.
-  Dual sensor On/Off-anti fog. Doppelter  
Sensorschalter. On/Off. Doppio sensore  
di con tatto. On/Off. Antiappannante.

### SIDES

Natural Oak

### SIDES AND FRONTS



S: Sides | F: Fronts

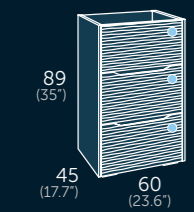

### NUBIA 60 (23.62")

Finishes **S F**  
 ● Natural Oak 119 24 XX 060  
 ● Mara Finishes 119 XX XX 060

Replace the X with the colour reference.  
 Ersetzen Sie das X durch die Farbfref.  
 Sostituire la X con il riferimento del colore.

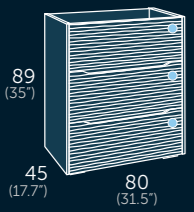

### NUBIA 80 (31.49")

Finishes **S F**  
 ● Natural Oak 119 24 XX 080  
 ● Mara Finishes 119 XX XX 080

Replace the X with the colour reference.  
 Ersetzen Sie das X durch die Farbfref.  
 Sostituire la X con il riferimento del colore.

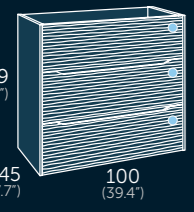

### NUBIA 100 (39.37")

Finishes **S F**  
 ● Natural Oak 119 24 XX 100  
 ● Mara Finishes 119 XX XX 100

Replace the X with the colour reference.  
 Ersetzen Sie das X durch die Farbfref.  
 Sostituire la X con il riferimento del colore.

**FINISHES IN STOCK**  
 / AUF LAGER VERFÜGBARE OBERFLÄCHEN  
 / FINITURE DISPONIBILI IN MAGAZZIN  
 Sides: Natural Oak and Black.  
 Fronts: White, Mist, Black, Mink, Leaf and Blue Space.

LAMINATED (sides only) / LAMINAT / LAMINATO

Natural Oak 24

MATTE LACQUER / MATTLACK / LACCATO OPACO

White 06	Flower 26
Mist 22	Leaf 25
Anthracite 03	Garden 73
Black 02	Island 23
Beige 05	Blue Space 10
Mink 19	Metallic Gold 16
Soil 20	Metallic Lead 17
Sunset 08	



<b>ONIX NEW</b> ceramic Reference ● Glossy White 550 01 060 ● Matte Colour 552 XX 060	<b>AMBAR / MARA</b> Reference ● Solid Surface 506 01 060 ● Resin Colour 540 XX 060	<b>ZEN / IRIS</b> Reference ● Solid Surface 555 01 060 ● Resin Colour 536 XX 060
--	---	---



<b>ONIX NEW</b> ceramic Reference ● Glossy White 550 01 080 ● Matte Colour 552 XX 080	<b>AMBAR / MARA</b> Reference ● Solid Surface 506 01 080 ● Resin Colour 540 XX 080	<b>ZEN / IRIS</b> Reference ● Solid Surface 555 01 080 ● Resin Colour 536 XX 080
--	---	---



<b>ONIX NEW</b> ceramic Reference ● Glossy White 550 01 100	<b>AMBAR / MARA</b> Reference ● Solid Surface 506 01 100 ● Resin Colour 540 XX 100	<b>ZEN / IRIS</b> Reference ● Solid Surface 555 01 100 ● Resin Colour 536 XX 100
---	---	---



<b>COMBI tap</b> Reference ● Chrome 412 00 800 ● Black 412 00 801 ● Gold 412 00 802	<b>COMBI tap</b> Reference ● Full Color 412 XX 803	<b>KUDO tap</b> Reference ● Brushed Steel 412 04 810 ● Black 412 02 810 ● Brushed Gold 412 03 810	<b>KUDO tap</b> Reference ● Full Color 412 XX 811	<b>WALL-MOUNTED tap</b> Reference ● Chrome 412 00 808 ● Black 412 02 808 ● Gold 412 03 808
---	--	---	---	--



<b>DRAIN clic clac</b> Reference ● Chrome 410 00 203 ● Black 410 02 203 ● White 410 01 203 ● Brushed Gold 410 03 203	<b>DRAIN clic clac</b> Reference ● Colour 409 XX 203	<b>LATERAL 38 towel rail</b> Reference ● Chrome 416 00 001 ● Black 416 02 001 ● White 416 27 001	<b>LUX 38 towel rail</b> Reference ● Chrome 417 00 038 ● Black 417 02 038 ● White 417 27 038	<b>HAIR DRYER support</b> Reference ● Black 419 02 001 ● Chrome 419 00 001
---	--	--	--	---

Replace the XX by the chosen colour code.  
 Ersetzen Sie XX durch den Code der ausgewählten Farbe.  
 Sostituire l'XX con il codice colore scelto.



<b>SUN</b> Reference 204 00 060	<b>SOUL</b> Reference 239 00 090	<b>ROND</b> Reference ● BLACK 244 02 060 ● GOLD 244 72 060	<b>RAIN LED</b> Reference 269 00 060	<b>VERONA LED</b> Reference 246 00 060	<b>JAZZ LED</b> Reference 271 02 050	<b>AURA STRAP LED</b> Reference 251 02 060	<b>ORION / OSIRIS LED</b> Reference ● Solid Surface 210 01 060 ● Resin Colour 211 XX 060
---------------------------------------	--	---	--	--	--	--	---

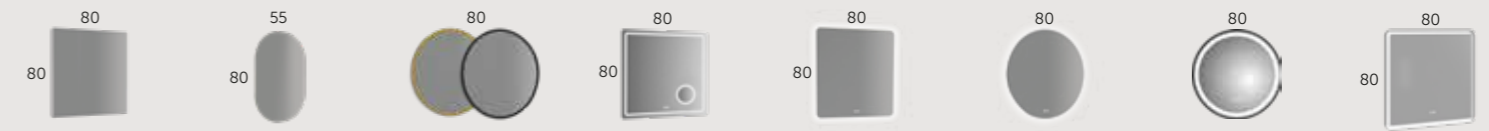

<b>SUN</b> Reference 204 00 080	<b>SOUL</b> Reference 239 00 080	<b>ROND</b> Reference ● BLACK 244 02 080 ● GOLD 244 72 080	<b>COSMOS LED</b> Reference 270 00 080	<b>VERONA LED</b> Reference 246 00 080	<b>VERONA ROND LED</b> Reference 247 00 080	<b>AURA LED</b> Reference 250 02 080	<b>ORION / OSIRIS LED</b> Reference ● Solid Surface 210 01 080 ● Resin Colour 211 XX 080
---------------------------------------	--	---	--	--	---	--	---



<b>SUN</b> Reference 204 00 100	<b>SOUL</b> Reference ● BLACK 239 02 090 ● GOLD 239 72 090	<b>ROND</b> Reference ● BLACK 244 02 100 ● GOLD 244 72 100	<b>COSMOS LED</b> Reference 270 00 100	<b>VERONA LED</b> Reference 246 00 100	<b>VERONA ROND LED</b> Reference 247 00 100	<b>AURA LED</b> Reference 250 02 100	<b>ORION / OSIRIS LED</b> Reference ● Solid Surface 210 01 100 ● Resin Colour 211 XX 100
---------------------------------------	---	---	--	--	---	--	---

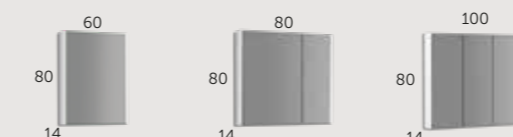

<b>SKYLINE 60 cabinet</b> Reference ● Matte White 341 35 060 ● Natural Oak 341 24 060 More colours on page: 422 1 Door	<b>SKYLINE 80 cabinet</b> Reference ● Matte White 341 35 080 ● Natural Oak 341 24 080 More colours on page: 422 2 Doors	<b>SKYLINE 100 cabinet</b> Reference ● Matte White 341 35 100 ● Natural Oak 341 24 100 More colours on page: 422 3 Doors
---	--	---



<b>ESTHER 30</b> Reference 400 00 141	<b>ESTHER BLACK 45</b> Reference 400 02 191	<b>SOFIA 60</b> Reference 400 00 141
---	---	--

### SPECIAL DRAWER / SPEZIALSCHUBLADE / CASSETTO SPECIALE

Check all the information on page 429.  
 Konsultieren Sie alle Informationen auf Seite 429.  
 Consulta tutte le informazioni nella pagina 429.

**OFFSET SIPHON CUTOUT**  
 / VERSCHIEBBARER SIPHON / SIFONE REGOLABILE  
 Ref: 432 00 001  
 A plan is required. Not available for the 60 cm size.  
 Plan erforderlich. Nicht verfügbar für die Größe 60 cm.  
 Piano richiesto. Non disponibile per la misura da 60 cm.

**WITHOUT SIPHON CUTOUT**  
 / OHNE SIPHON / SENZA SIFONE  
 Ref: 432 00 000

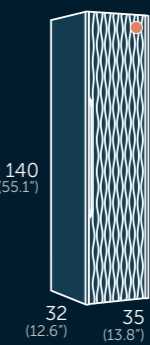

S: Sides | F: Front

### SÁHARA TALL

Finishes **S F**  
 ● Natural Oak 120 24 XX 335  
 ● Mara Finishes 120 XX XX 335

Replace the XX with the colour reference.  
 Ersetzen Sie das XX durch die Farbfref.  
 Sostituire la XX con il riferimento del colore.

Reversible opening | Reversible Öffnung  
 | Apertura reversibile



# CERVINO

70 | 80 | 90 | 100

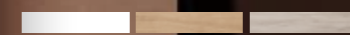

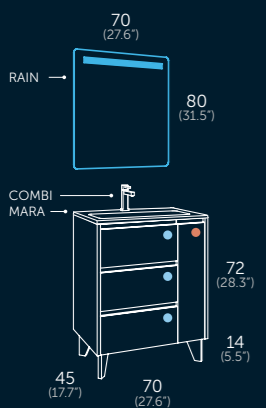



### CERVINO 70

- 141 01 070 Cervino 70
- 540 10 070 Mara Blue Space
- 269 00 070 Rain
- 412 00 800 Combi Chrome





 Organizer unit. Utensilien Behälter. Organizzatore.

 Adjustable front. Einstellbare Vorderseite. Frontali regolabili.

 Soft close. Soft-close-System. Chiusura ammortizzata.

 Hettich sliding system. Korpuschiene Hettich. Guide Hettich.

 Soft close. Soft-close-System. Chiusura ammortizzata.

 Glossy lacquered finish. Glanzend lackiert. Laccato lucido.

- Glossy White
- Natural Oak
- Grey Pine



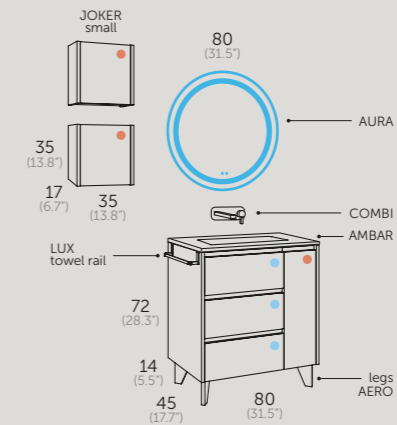

- Glossy White
- Natural Oak
- Grey Pine

## CERVINO 80

141 37 080 Cervino 80  
 506 01 080 G Ambar  
 without tap drilling / Ohne Armaturenloch  
 / Senza foro per rubinetto

250 02 080 Aura  
 412 02 121 Legs Aero Black / Beine / Gambe  
 137 37 445 Joker Small Grey Pine / Klein / Piccolo  
 417 02 038 Towel rail Lux 38 Black / Handtuchhalter  
 / Porta asciugamani  
 412 02 808 Combi Wall-Mounted Black



Organizer unit.  
 Utensilien Behälter.  
 Organizzatore.



Adjustable front.  
 Einstellbare Vorderseite.  
 Frontali regolabili.



Soft close.  
 Soft-close-System.  
 Chiusura ammortizzata.



Hettich sliding system.  
 Korpuschiene Hettich.  
 Guide Hettich.



Soft close.  
 Soft-close-System.  
 Chiusura ammortizzata.



Anti fog system.  
 Anti-Beschlag-System.  
 Sistema antiappannamento.



Dual sensor On/Off-anti fog.  
 Doppelter Sensorschalter. On/Off.  
 Doppio sensore touch. On/Off.  
 Antiappannante.



Organizer unit. Utensilien Behälter.  
Organizzatore.



Adjustable front. Einstellbare  
Vorderseite. Frontali regolabili.



Soft close. Soft-close-System.  
Chiusura ammortizzata.



Hettich sliding system. Körperschiene  
Hettich. Guide Hettich.



Soft close. Soft-close-System.  
Chiusura ammortizzata.



Bluetooth music player. 2 speakers  
of 3W each. Musik Player integriert,  
Bluetooth Anschluss. 2 Lautsprecher  
je mit 3W. Lettore musicale integrato,  
connessione a Bluetooth. 2 altoparlanti  
3W ciascuno.

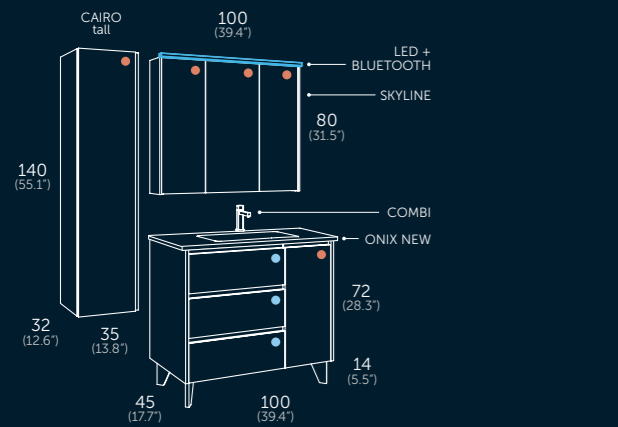

## CERVINO 100

- 141 24 100 Cervino 100
- 550 01 100 Onix New
- 405 01 000 Overflow cover Glossy White  
/ Überlaufblende / Coprirubinetto
- 341 24 100 Skyline Natural Oak
- 400 00 531 LED + Bluetooth
- 194 24 335 Cairo Tall Natural Oak / Hoch / Alto
- 412 00 800 Chrome Combi



Glossy White   Natural Oak   Grey Pine







### CERVINO 70 (27.55")



72 (28.3")  
14 (5.5")  
45 (17.7")  
70 (27.6")

Finishes  
 ● Glossy White  
 ● Natural Oak  
 ● Grey Pine

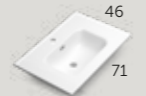
Reference  
 141 01 070  
 141 24 070  
 141 37 070

**ONIX NEW** ceramic  
Reference  
 ● Glossy White  
 550 01 070  
 ● Matte Colour  
 552 XX 070

**AMBAR / MARA**  
Reference  
 ● Solid Surface  
 506 01 070  
 ● Resin Colour  
 540 XX 070

**ZEN / IRIS**  
Reference  
 ● Solid Surface  
 555 01 070  
 ● Resin Colour  
 536 XX 070



### CERVINO 80 (31.49")



72 (28.3")  
14 (5.5")  
45 (17.7")  
80 (31.5")

Finishes  
 ● Glossy White  
 ● Natural Oak  
 ● Grey Pine

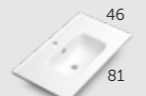
Reference  
 141 01 080  
 141 24 080  
 141 37 080

**ONIX NEW** ceramic  
Reference  
 ● Glossy White  
 550 01 080  
 ● Matte Colour  
 552 XX 080

**AMBAR / MARA**  
Reference  
 ● Solid Surface  
 506 01 080  
 ● Resin Colour  
 540 XX 080

**ZEN / IRIS**  
Reference  
 ● Solid Surface  
 555 01 080  
 ● Resin Colour  
 536 XX 080

### CERVINO 90 (35.43")



72 (28.3")  
14 (5.5")  
45 (17.7")  
90 (35.4")

Finishes  
 ● Glossy White  
 ● Natural Oak  
 ● Grey Pine

Reference  
 141 01 090  
 141 24 090  
 141 37 090





**ONIX NEW** ceramic  
Reference  
 ● Glossy White  
 550 01 090

**AMBAR / MARA**  
Reference  
 ● Solid Surface  
 506 01 090  
 ● Resin Colour  
 506 XX 090

**ZEN / IRIS**  
Reference  
 ● Solid Surface  
 555 01 090  
 ● Resin Colour  
 536 XX 090



### CERVINO 100 (39.37")



72 (28.3")  
14 (5.5")  
45 (17.7")  
100 (39.4")

Finishes  
 ● Glossy White  
 ● Natural Oak  
 ● Grey Pine

Reference  
 141 01 100  
 141 24 100  
 141 37 100

**ONIX NEW** ceramic  
Reference  
 ● Glossy White  
 550 01 100

**AMBAR / MARA**  
Reference  
 ● Solid Surface  
 506 01 100  
 ● Resin Colour  
 540 XX 100

**ZEN / IRIS**  
Reference  
 ● Solid Surface  
 555 01 100  
 ● Resin Colour  
 536 XX 100







**COMBI** tap  
Reference  
 ● Chrome  
 412 00 800  
 ● Black  
 412 00 801  
 ● Gold  
 412 00 802  
 ● Full Color  
 412 XX 803







**KUDO** tap  
Reference  
 ● Brushed Steel  
 412 04 810  
 ● Black  
 412 02 810  
 ● Brushed Gold  
 412 03 810  
 ● Full Color  
 412 XX 811

**DRAIN** clic clac  
Reference  
 ● Chrome  
 410 00 203  
 ● Black  
 410 02 203  
 ● Brushed Gold  
 410 03 203  
 ● Colour  
 409 XX 203

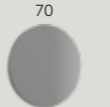
**LUX 38** towel rail  
Reference  
 ● Chrome  
 417 00 038  
 ● Black  
 417 02 038  
 ● White  
 417 27 038

**AERO LEGS** 14 cm  
Reference  
 ● Black  
 412 02 121  
 4 units

Replace the **XX** by the chosen colour code. See codes on page 447.  
 Ersetzen Sie **XX** durch den Code der ausgewählten Farbe. Siehe Seite 447 für Farbcodes.  
 Sostituire l'**XX** con il codice colore scelto. Vedere i codici a pagina 447.

**SUN**  
Reference  
 204 00 070

**ROND**  
Reference  
 244 00 070

**TOSCANA**  
Reference  
 ● Natural Oak  
 296 24 060



**RAIN LED**  
Reference  
 269 00 070

**VERONA ROND LED**  
Reference  
 247 00 070

**VERONA LED**  
Reference  
 246 00 070

**AURA STRAP LED**  
Reference  
 251 02 070

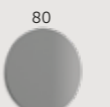
**FLASH 70** cabinet  
Reference  
 ● Aluminium  
 340 11 070  
 2 Doors

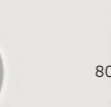
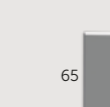
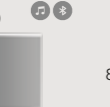
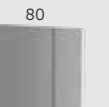
**SUN**  
Reference  
 204 00 080

**ROND**  
Reference  
 244 00 080

**TOSCANA**  
Reference  
 ● Natural Oak  
 296 24 080



**RAIN LED**  
Reference  
 269 00 080

**VERONA ROND LED**  
Reference  
 247 00 080

**VERONA LED**  
Reference  
 246 00 080

**SPOTY LED**  
Reference  
 267 00 080



**SKYLINE 80** cabinet  
Reference  
 ● Glossy White  
 341 01 080  
 ● Natural Oak  
 341 24 080  
 2 Doors







**SUN**  
Reference  
 204 00 090

**ROND**  
Reference  
 244 00 090

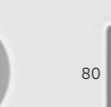
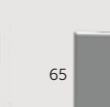
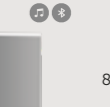
**STONE LED**  
Reference  
 261 00 080

**SUN**  
Reference  
 204 00 100

**ROND**  
Reference  
 244 00 100

**TOSCANA**  
Reference  
 ● Natural Oak  
 296 24 100

**RAIN LED**  
Reference  
 269 00 100

**VERONA ROND LED**  
Reference  
 247 00 100

**VERONA LED**  
Reference  
 246 00 100

**SPOTY LED**  
Reference  
 267 00 100

**SKYLINE 100** cabinet  
Reference  
 ● Glossy White  
 341 01 100  
 ● Natural Oak  
 341 24 100  
 3 Doors



**ESTHER 30**  
Reference  
 400 00 141

**ESTHER BLACK 30**  
Reference  
 400 02 141



### SPECIAL DRAWER SPEZIALSCHUBLADE / CASSETTO SPECIALE

Check all the information on page 429.  
 Konsultieren Sie alle Informationen auf Seite 429.  
 Consulta tutte le informazioni nella pagina 429.

**OFFSET SIPHON CUTOUT**  
 / VERSCHIEBBARER SIPHON / SIFONE REGOLABILE  
 Ref: 432 00 002

A plan is required. Only movable to the left.  
 Not available for the 70 cm size.  
 Es wird ein Plan benötigt. Nur nach links verschiebbar.  
 Nicht verfügbar in der Größe 70 cm.  
 È necessario un piano. Solo spostabile a sinistra.  
 Non disponibile per la misura di 70 cm.

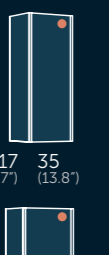
**WITHOUT SIPHON CUTOUT**  
 / OHNE SIPHON / SENZA SIFONE  
 Ref: 432 00 000

**CAIRO TALL**  
 Finishes  
 ● Glossy White  
 ● Natural Oak  
 ● Grey Pine  
 Reversible opening | Umkehrbare Öffnung | Apertura reversibile

Reference  
 194 01 335  
 194 24 335  
 194 37 335

140 (55.1")  
 80 (31.5")  
 32 (12.6")  
 35 (13.8")

**JOKER MEDIUM**  
 Finishes  
 ● Glossy White  
 ● Natural Oak  
 ● Grey Pine  
 Reversible opening | Umkehrbare Öffnung | Apertura reversibile

Reference  
 137 01 435  
 137 24 435  
 137 37 435

**JOKER SMALL**  
 Finishes  
 ● Glossy White  
 ● Natural Oak  
 ● Grey Pine  
 Reversible opening | Umkehrbare Öffnung | Apertura reversibile

Reference  
 137 01 445  
 137 24 445  
 137 37 445





# ESCORPIO

60 | 70 | 80 | 100





-  Organizer unit. Utensilien Behälter. Organizzatore.
-  Adjustable front. Einstellbare Vorderseite. Frontali regolabili.
-  Soft close. Soft-close-System. Chiusura ammortizzata.
-  Hettich sliding system. Korpuschiene Hettich. Guide Hettich.
-  Soft close. Soft-close-System. Chiusura ammortizzata.
-  Anti fog system. Anti-Beschlag-System. Sistema antiappannamento.
-  Ambient light. Umgebungslicht. Luce ambiente.
-  Intensity control. Intensitätsregler. Regolatore di intensità.
-  Dual sensor On/Off anti fog. Doppelter Sensorschalter. On/Off. Doppio sensore di con tatto. On/Off. Antiappannante.

## ESCORPIO 60

- 146 37 060 N Escorpio 60
- 550 01 060 Onix New
- 239 02 080 Soul Black
- 400 02 141 Esther Black 30
- 137 37 435 Joker Medium Grey Pine / Mittel / Medio
- 412 00 801 Combi Black

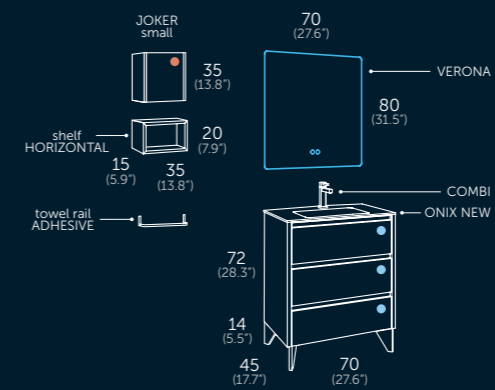
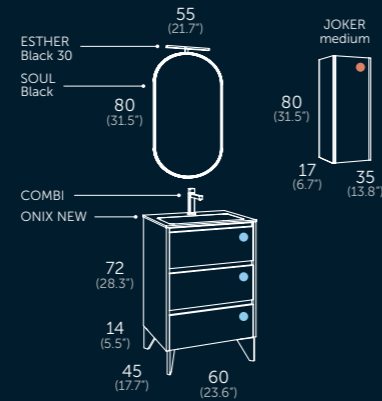

## ESCORPIO 70

- 146 24 070 C Escorpio 70
- 550 01 070 Onix New
- 246 00 070 Verona
- 416 00 037 Adhesive Towel rail 3M Chrome / Klebehandtuchhalter 3M / Portasciugamani adesivo 3M
- 137 24 445 Joker Small Natural Oak / Klein / Piccolo
- 112 45 505 Horizontal Shelf Anthracite / Horizontales Regal / Scaffale Orizzontale
- 412 03 800 Combi Chrome - Anthracite



### FURNITURE

- Glossy White
- Natural Oak
- Grey Pine
- Matte Mink

### HANDLES AND LEGS

- Matte Chrome
- Matte Black

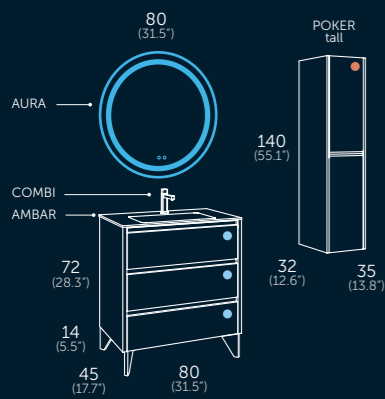

## ESCORPIO 80

146 74 080 N Escorpio 80  
506 01 080 Ambar  
250 02 080 Aura  
167 74 335 N Poker Tall Mink / Hoch / Alto  
412 00 801 Combi Black



### FURNITURE

Glossy White Natural Oak Grey Pine Matte Mink

### HANDLES AND LEGS

Matte Chrome Matte Black



Organizer unit. Utensilien Behälter. Organizzatore.



Adjustable front. Einstellbare Vorderseite. Frontali regolabili.



Soft close. Soft-close-System. Chiusura ammortizzata.



Soft close. Soft-close-System. Chiusura ammortizzata.



Hettich sliding system. Korpuschiene Hettich. Guide Hettich.



Anti fog system. Anti-Beschlag-System. Sistema antiappannamento.



Dual sensor On/Off-anti fog. Doppelter Sensorschalter. On/Off. Doppio sensore di con tatto. On/Off. Antiappannante.



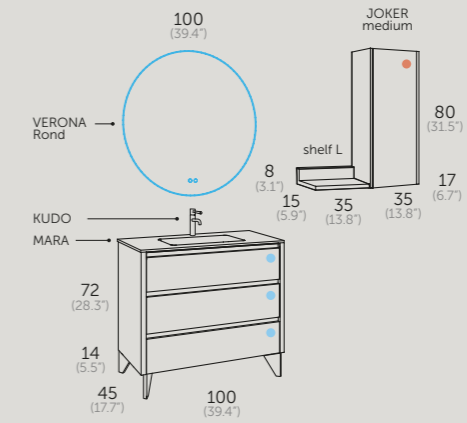

### ESCORPIO 100

- 146 01 100 C Escorpio 100
- 540 08 100 Mara Sunset
- 247 00 100 Verona Rond
- 137 47 435 Joker Medium Leaf / Mittel / Medio
- 112 48 520 Shelf L Sunset / Regal L / Scaffale L
- 412 04 810 Kudo Brushed Steel / Gebürsteter / Spazzolato



-  Organizer unit.  
Utensilien Behälter.  
Organizzatore.
-  Adjustable front.  
Einstellbare Vorderseite.  
Frontal regolabili.
-  Soft close.  
Soft-close-System.  
Chiusura ammortizzata.
-  Hettich sliding system.  
Korpusschiene Hettich.  
Guide Hettich.
-  Soft close.  
Soft-close-System.  
Chiusura ammortizzata.
-  Glossy lacquered finish.  
Glanzend lackiert.  
Laccato lucido.
-  Anti fog system.  
Anti-Beschlag-System.  
Sistema antiappannamento.
-  Ambient light.  
Umgebungslicht.  
Luce ambiente.
-  Intensity control.  
Intensitätsregler.  
Regolatore di intensità.
-  Dual sensor On/Off-anti fog.  
Doppelter Sensorschalter. On/Off.  
Doppio sensore touch. On/Off.  
Antiappannante.

#### FURNITURE

- Glossy White
- Natural Oak
- Grey Pine
- Matte Mink

#### HANDLES AND LEGS

- Matte Chrome
- Matte Black



### ESCORPIO 60 (23.62")

72 (28.3")  
14 (5.5")  
45 (17.7")  
60 (23.6")

Finishes Reference

- Glossy White 146 01 060 (X)
- Natural Oak 146 24 060 (X)
- Grey Pine 146 37 060 (X)
- Matte Mink 146 74 060 (X)

Replace the X with the colour reference of the handles and legs:  
Ersetzen Sie das X durch die Farbreferenz der Griffe und Beine:  
Sostituire la X con il riferimento colore delle maniglie e delle gambe:

● Chrome (C) ○ Black (N)

46 61 46 61 46 61

**ONIX NEW** ceramic Reference  
● Glossy White 550 01 060  
● Matte Colour 552 XX 060

**AMBAR / MARA** Reference  
● Solid Surface 506 01 060  
● Resin Colour 540 XX 060

**ZEN / IRIS** Reference  
● Solid Surface 555 01 060  
● Resin Colour 536 XX 060

60 80 45 90 60 60 60 80 50 60 68 14

**SUN** Reference 204 00 060

**SOUL** Reference 239 00 090

**ROND BLACK** Reference 244 02 060

**RAIN LED** Reference 269 00 060

**VERONA LED** Reference 246 00 060

**JAZZ LED** Reference 271 02 050

**AURA STRAP LED** Reference 251 02 060

**FLASH 60 cabinet** Reference  
● Aluminium 340 11 060  
1 Door

### ESCORPIO 70 (27.55")

72 (28.3")  
14 (5.5")  
45 (17.7")  
70 (27.6")

Finishes Reference

- Glossy White 146 01 070 (X)
- Natural Oak 146 24 070 (X)
- Grey Pine 146 37 070 (X)
- Matte Mink 146 74 070 (X)

Replace the X with the colour reference of the handles and legs:  
Ersetzen Sie das X durch die Farbreferenz der Griffe und Beine:  
Sostituire la X con il riferimento colore delle maniglie e delle gambe:

● Chrome (C) ○ Black (N)

46 71 46 71 46 71

**ONIX NEW** ceramic Reference  
● Glossy White 550 01 070  
● Matte Colour 552 XX 070

**AMBAR / MARA** Reference  
● Solid Surface 506 01 070  
● Resin Colour 540 XX 070

**ZEN / IRIS** Reference  
● Solid Surface 555 01 070  
● Resin Colour 536 XX 070

70 80 55 80 70 70 70 70 70 70 68 14

**SUN** Reference 204 00 070

**SOUL** Reference 239 00 080

**ROND BLACK** Reference 244 02 070

**RAIN LED** Reference 269 00 070

**VERONA LED** Reference 246 00 070

**VERONA ROND LED** Reference 247 00 070

**AURA STRAP LED** Reference 251 02 070

**FLASH 70 cabinet** Reference  
● Aluminium 340 11 070  
2 Doors

### ESCORPIO 80 (31.49")

72 (28.3")  
14 (5.5")  
45 (17.7")  
80 (31.5")

Finishes Reference

- Glossy White 146 01 080 (X)
- Natural Oak 146 24 080 (X)
- Grey Pine 146 37 080 (X)
- Matte Mink 146 74 080 (X)

Replace the X with the colour reference of the handles and legs:  
Ersetzen Sie das X durch die Farbreferenz der Griffe und Beine:  
Sostituire la X con il riferimento colore delle maniglie e delle gambe:

● Chrome (C) ○ Black (N)

46 81 46 81 46 81

**ONIX NEW** ceramic Reference  
● Glossy White 550 01 080  
● Matte Colour 552 XX 080

**AMBAR / MARA** Reference  
● Solid Surface 506 01 080  
● Resin Colour 540 XX 080

**ZEN / IRIS** Reference  
● Solid Surface 555 01 080  
● Resin Colour 536 XX 080

80 80 80 80 80 80 80 80 80 65

**SUN** Reference 204 00 080

**ROND** Reference 244 00 080

**ROND BLACK** Reference 244 02 080

**COSMOS LED** Reference 270 00 080

**VERONA LED** Reference 246 00 080

**VERONA ROND LED** Reference 247 00 080

**AURA LED** Reference 250 02 080

**SPOTY LED** Reference 267 00 080

### ESCORPIO 100 (39.37")

72 (28.3")  
14 (5.5")  
45 (17.7")  
100 (39.4")

Finishes Reference

- Glossy White 146 01 100 (X)
- Natural Oak 146 24 100 (X)
- Grey Pine 146 37 100 (X)
- Matte Mink 146 74 100 (X)

Replace the X with the colour reference of the handles and legs:  
Ersetzen Sie das X durch die Farbreferenz der Griffe und Beine:  
Sostituire la X con il riferimento colore delle maniglie e delle gambe:

● Chrome (C) ○ Black (N)

46 101 46 101 46 101

**ONIX NEW** ceramic Reference  
● Glossy White 550 01 100  
● Matte Colour 552 XX 100

**AMBAR / MARA** Reference  
● Solid Surface 506 01 100  
● Resin Colour 540 XX 100

**ZEN / IRIS** Reference  
● Solid Surface 555 01 100  
● Resin Colour 536 XX 100

100 80 100 100 100 100 100 100 100 65

**SUN** Reference 204 00 100

**ROND** Reference 244 00 100

**ROND BLACK** Reference 244 02 100

**COSMOS LED** Reference 270 00 100

**VERONA LED** Reference 246 00 100

**VERONA ROND LED** Reference 247 00 100

**AURA LED** Reference 250 02 100

**SPOTY LED** Reference 267 00 100

### SPECIAL DRAWER

SPEZIALSCHUBLADE / CASSETTO SPECIALE

Check all the information on page 429.  
Konsultieren Sie alle Informationen auf Seite 429.  
Consulta tutte le informazioni nella pagina 429.

**OFFSET SIPHON CUTOUT**  
/ VERSCHIEBBARER SIPHON / SIFONE REGOLABILE  
Ref: 432 00 002

A plan is required. Not available for the 60 cm size.  
Plan erforderlich. Nicht verfügbar für die Größe 60 cm.  
Piano richiesto. Non disponibile per la misura da 60 cm.

**WITHOUT SIPHON CUTOUT**  
/ OHNE SIPHON / SENZA SIFONE  
Ref: 432 00 000

210 210 210 210 210

**COMBI tap** Reference  
● Chrome 412 00 800  
● Black 412 00 801  
● Gold 412 00 802  
● Full Color 412 XX 803

**KUDO tap** Reference  
● Brushed Steel 412 04 810  
● Black 412 02 810  
● Brushed Gold 412 03 810  
● Full Color 412 XX 811

**DRAIN clic clac** Reference  
● Chrome 410 00 203  
● Black 410 02 203  
● Brushed Gold 410 03 203  
● Colour 409 XX 203

**LUX 38 towel rail** Reference  
● Chrome 417 00 038  
● Black 417 02 038  
● White 417 27 038

**ESTHER BLACK 30** Reference  
400 02 141

Replace the XX by the chosen colour code. See codes on page 447.  
Ersetzen Sie XX durch den Code der ausgewählten Farbe. Siehe Seite 447 für Farbcodes.  
Sostituire l'XX con il codice colore scelto. Vedere i codici a pagina 447.

140 (55.1")  
32 (12.6")  
35 (13.8")

**POKER TALL** Reference  
● Glossy White 167 01 335 (X)  
● Natural Oak 167 24 335 (X)  
● Grey Pine 167 37 335 (X)  
● Matte Mink 167 74 335 (X)

Replace the X with the handle reference:  
Ersetzen Sie das X durch die Griffreferenz:  
Sostituire la X con il riferimento della maniglia:

● Chrome (C) ○ Black (N)  
Reversible opening | Umkehrbare Öffnung | Apertura reversibile

80 (31.5")  
17 (6.7")  
35 (13.8")

**JOKER MEDIUM** Reference  
● Glossy White 137 01 435  
● Natural Oak 137 24 435  
● Grey Pine 137 37 435  
● Matte Mink 137 74 435

Reversible opening | Umkehrbare Öffnung | Apertura reversibile

35 (13.8")  
17 (6.7")  
35 (13.8")

**JOKER SMALL** Reference  
● Glossy White 137 01 445  
● Natural Oak 137 24 445  
● Grey Pine 137 37 445  
● Matte Mink 137 74 445

Reversible opening | Umkehrbare Öffnung | Apertura reversibile



REDUCED DEPTH

# COMET

60 | 70 | 80

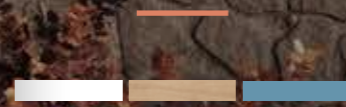



-  Organizer unit.  
Utensilien Behälter.  
Organizatore.
-  Adjustable front.  
Einstellbare Vorderseite.  
Frontali regolabili.
-  Soft close.  
Soft-close-System.  
Chiusura ammortizzata.
-  Hettich sliding system.  
Korpusschiene Hettich.  
Guide Hettich.
-  Soft close.  
Soft-close-System.  
Chiusura ammortizzata.
-  Glossy lacquered finish.  
Glanzend lackiert.  
Laccato lucido.

**FURNITURE**

- Glossy White
- Natural Oak
- Matte Island

**HANDLES**

- Matte Chrome
- Matte Black
- Matte Gold

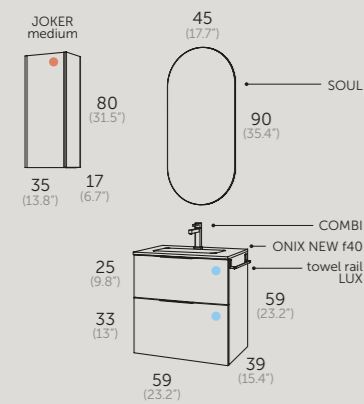

**COMET 60 REDUCED DEPTH**  
REDUZIERTER TIEFE / PROFONDITÀ RIDOTTA

- 152 01 060 C Comet 60
- 551 01 060 Onix New f40
- 405 01 000 Overflow Cover Glossy White / Überlaufabdeckung / Copertura Troppo Pieno
- 239 00 090 Soul
- 417 00 032 Towel rail Lux 30 Chrome / Handtuchhalter / Portaciugamani
- 137 01 435 Joker Medium White / Mittel / Medio
- 412 00 800 Combi Chrome





Organizer unit.  
Utensilien Behälter.  
Organizzatore.

Adjustable front.  
Einstellbare Vorderseite.  
Frontali regolabili.

Soft close.  
Soft-close-System.  
Chiusura ammortizzata.

Hettich sliding system.  
Korpusschiene Hettich.  
Guide Hettich.

Soft close.  
Soft-close-System.  
Chiusura ammortizzata.



**COMET 70 REDUCED DEPTH**  
REDUZIERTA TIEFE / PROFONDITÀ RIDOTTA

- 152 24 070 N Comet 70
- 551 01 070 Onix New f40
- 244 02 070 Rond Black
- 412 02 752 Leg IND with towel rail / IND-Fuß mit Handtuchhalter / Gamba IND con portaasciugamani
- 412 02 750 Leg IND without towel rail / IND-Fuß ohne Handtuchhalter / Gamba IND senza portaasciugamani
- 137 24 445 Joker Small Natural Oak / Klein / Piccolo
- 137 24 455 Joker Shelf Natural Oak / Regal / Scaffale
- 412 02 810 Kudo Black

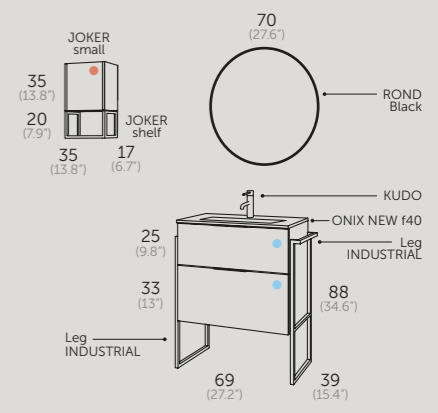

FURNITURE  
Glossy White | Natural Oak | Matte Island

HANDLES  
Matte Chrome | Matte Black | Matte Gold

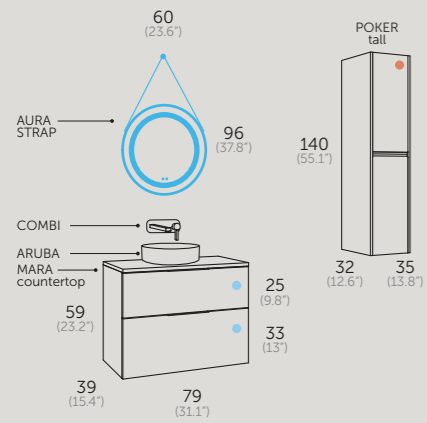

**COMET 80 REDUCED DEPTH**  
REDUZIERTE TIEFE / PROFONDITÀ RIDOTTA

- 152 49 080 G Comet 80
- 546 02 080 Mara Countertop Black / Waschtischplatte / Piano
- 425 14 080 Reinforcement Bar / Waschtischplatten-Stabilisierung / Barra di rinforzo
- 581 02 037 Aruba Black
- 251 02 060 Aura Strap
- 167 49 335 G Poker Tall Island / Hoch / Alto
- 412 03 808 Combi Wall-Mounted Gold



- Organizer unit.  
Utensilien Behälter.  
Organizzatore.
- Adjustable front.  
Einstellbare Vorderseite.  
Frontali regolabili.
- Soft close.  
Soft-close-System.  
Chiusura ammortizzata.
- Hettich sliding system.  
Korpusschiene Hettich.  
Guide Hettich.
- Soft close.  
Soft-close-System.  
Chiusura ammortizzata.
- Anti fog system.  
Anti-Beschlag-System.  
Sistema antiappannamento.
- Dual sensor On/Off-anti fog.  
Doppelter Sensorschalter. On/Off.  
Doppio sensore touch. On/Off.  
Antiappannante.

**FURNITURE**

- Glossy White
- Natural Oak
- Matte Island

**HANDLES**

- Matte Chrome
- Matte Black
- Matte Gold



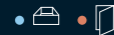

### COMET 60 (23.62")

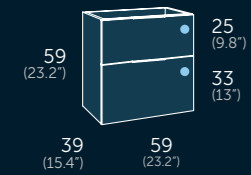

- Finishes Reference
- Glossy White 152 01 060 (X)
  - Natural Oak 152 24 060 (X)
  - Matte Island 152 49 060 (X)
- Replace the X with the handle reference:  
Ersetzen Sie das X durch die Griffreferenz:  
Sostituire la X con la referenza della maniglia:
- Chrome (C) ○ Black (N) ● Gold (G)



- ONIX NEW F40 ceramic** Reference
- Glossy White 551 01 060
  - Matte Colour 553 XX 060
- AMBAR/MARA countertop** Reference
- Solid Surface 533 01 060
  - Resin Colour 546 XX 060



- ONIX NEW F40 ceramic** Reference
- Glossy White 551 01 070
  - Matte Colour 553 XX 070
- AMBAR/MARA countertop** Reference
- Solid Surface 533 01 070
  - Resin Colour 546 XX 070

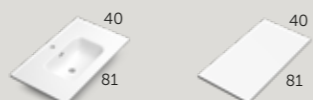

- ONIX NEW F40 ceramic** Reference
- Glossy White 551 01 080
  - Matte Colour 553 XX 080
- AMBAR/MARA countertop** Reference
- Solid Surface 533 01 080
  - Resin Colour 546 XX 080

### COMET 70 (27.55")

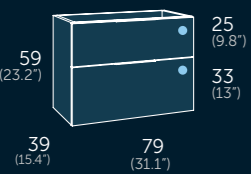

- Finishes Reference
- Glossy White 152 01 070 (X)
  - Natural Oak 152 24 070 (X)
  - Matte Island 152 49 070 (X)
- Replace the X with the handle reference:  
Ersetzen Sie das X durch die Griffreferenz:  
Sostituire la X con la referenza della maniglia:
- Chrome (C) ○ Black (N) ● Gold (G)

### COMET 80 (31.49")

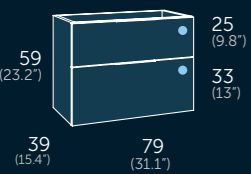

- Finishes Reference
- Glossy White 152 01 080 (X)
  - Natural Oak 152 24 080 (X)
  - Matte Island 152 49 080 (X)
- Replace the X with the handle reference:  
Ersetzen Sie das X durch die Griffreferenz:  
Sostituire la X con la referenza della maniglia:
- Chrome (C) ○ Black (N) ● Gold (G)

countertop washbasins / Aufsatzwaschbecken / lavabi da appoggio



- DUE ceramic** Reference
- Glossy White 530 01 002
- TRE 50 ceramic** Reference
- Glossy White 530 01 035
  - Matte Colour 535 XX 035
- ATENAS / ARUBA** Reference
- Solid Surface 580 01 037
  - Resin Colour 581 XX 037
- ZANTE / SAONA** Reference
- Solid Surface 559 01 050
  - Resin Colour 586 XX 049
- BARBADOS resin deco** Reference
- Carrara 583 76 037
  - Marquina Storm 583 77 037
  - Pure cement 583 95 037

taps / Armaturen / rubinetti



- COMBI tap** Reference
- Chrome 412 00 800
  - Black 412 00 801
  - Gold 412 00 802
  - Full Color 412 XX 803
- COMBI ALTO tap** Reference
- Chrome 412 00 805
  - Black 412 00 806
  - Gold 412 00 807
  - Full Color 412 XX 804
- KUDO tap** Reference
- Brushed Steel 412 04 810
  - Black 412 02 810
  - Brushed Gold 412 03 810
  - Full Color 412 XX 811
- KUDO ALTO tap** Reference
- Brushed Steel 412 04 815
  - Black 412 02 815
  - Brushed Gold 412 03 815
  - Full Color 412 XX 816
- WALL-MOUNTED tap** Reference
- Chrome 412 00 808
  - Black 412 02 808
  - Gold 412 03 808

Replace the **XX** by the chosen colour code. See codes on page 447.  
Ersetzen Sie **XX** durch den Code der ausgewählten Farbe. Siehe Seite 447 für Farbcodes.  
Sostituire **XX** con il codice colore scelto. Vedere i codici a pagina 447.

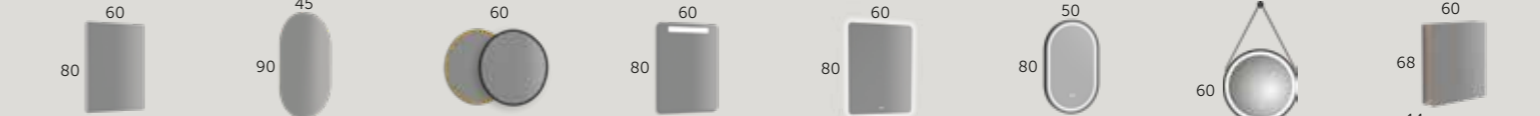

- SUN** Reference 204 00 060
- SOUL** Reference 239 00 090
- ROND** Reference
- Black 244 02 060
  - GOLD 244 72 060
- RAIN LED** Reference 269 00 060
- VERONA LED** Reference 246 00 060
- JAZZ LED** Reference 271 02 050
- AURA STRAP LED** Reference 251 02 060
- FLASH 60 cabinet** Reference
- Aluminium 340 11 060
  - 1 Door



- SUN** Reference 204 00 070
- SOUL** Reference 239 00 080
- ROND** Reference
- Black 244 02 070
  - GOLD 244 72 070
- RAIN LED** Reference 269 00 070
- VERONA LED** Reference 246 00 070
- VERONA ROND LED** Reference 247 00 070
- AURA LED** Reference 250 02 070
- FLASH 70 cabinet** Reference
- Aluminium 340 11 070
  - 2 Doors



- SUN** Reference 204 00 080
- NITRO** Reference 241 00 080
- ROND** Reference
- Black 244 02 080
  - GOLD 244 72 080
- RAIN LED** Reference 269 00 080
- VERONA LED** Reference 246 00 080
- VERONA ROND LED** Reference 247 00 080
- AURA LED** Reference 250 02 080
- FLASH 80 cabinet** Reference
- Aluminium 340 11 080
  - 2 Doors

accessories / Zubehör / complementi



- DRAIN clic clac** Reference
- Chrome 410 00 203
  - Black 410 02 203
  - Brushed Gold 410 03 203
- DRAIN clic clac** Reference
- Colour 409 XX 203
- LATERAL 30 towel rail** Reference
- Chrome 416 00 039
  - Black 416 02 039
- LUX 30 towel rail** Reference
- Chrome 417 00 032
  - Black 417 02 032
- PATA INDUSTRIAL** Reference
- Without towel rail 412 02 750
  - With towel rail 412 02 752
- LEGS KUADRO** Reference
- Black 412 02 720
  - Aluminium 412 00 720
  - 2 units
- NEREA MATTE 30** Reference 400 14 141
- ESTHER BLACK 45** Reference 400 02 191

REINFORCEMENT BAR ALUMINIUM

cm	Reference
60	425 14 060
70	425 14 070
80	425 14 080

It is necessary to install it to prevent deformation of the countertop.  
Es ist notwendig, es zu installieren, um Verformungen der Arbeitsplatte zu vermeiden.  
È necessario installarlo per evitare deformazioni del piano.

**DRILLING SERVICE**  
Plan required.  
Ref: 435 00 050

side cabinets and shelves / Hängeschränke und Regale / armadi e scaffali



### POKER TALL

- Finishes Reference
- Glossy White 167 01 335 (X)
  - Natural Oak 167 24 335 (X)
  - Matte Island 167 49 335 (X)
- Replace the X with the handle reference:  
Ersetzen Sie das X durch die Griffreferenz:  
Sostituire la X con la referenza della maniglia:
- Chrome (C) ○ Black (N) ● Gold (G)
- Reversible opening | Umkehrbare Öffnung  
| Apertura reversibile

### JOKER MEDIUM

- Finishes Reference
- Glossy White 137 01 435
  - Natural Oak 137 24 435
  - Matte Island 137 49 435
- Reversible opening | Umkehrbare Öffnung  
| Apertura reversibile



### JOKER SHELF

- Finishes Reference
- Glossy White 137 01 455
  - Natural Oak 137 24 455
  - Matte Island 137 49 455
- Only for Joker Medium and Joker Small.  
Nur für Joker Mittel und Joker Klein.  
Solo per Joker Medio e Joker Piccolo.

### JOKER SMALL

- Finishes Reference
- Glossy White 137 01 445
  - Natural Oak 137 24 445
  - Matte Island 137 49 445
- Reversible opening | Umkehrbare Öffnung  
| Apertura reversibile

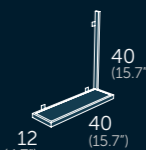

### SHELF IND

- Finishes Reference
- Glossy White 412 01 700
  - Natural Oak 412 24 700
  - Matte Island 412 49 700
- Compatible with all SUN mirror sizes.  
Right location only.  
Kompatibel mit allen Größen des Spiegels  
SUN. Nur an der richtigen Stelle.  
Compatibile con tutte le dimensioni degli  
specchi SUN. Solo nella posizione corretta.



REDUCED DEPTH

# BAMBI

50 | 60

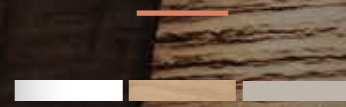

**BAMBI 50 REDUCED DEPTH**  
 REDUZIERTER TIEFE / PROFONDITÀ RIDOTTA

- 114 24 050 C Bambi 50
- 554 01 050 Elsa 50
- 204 00 050 Sun
- 400 00 121 Esther 30
- 137 24 435 Joker Medium Natural Oak / Mittel / Medio
- 412 00 800 Combi Chrome

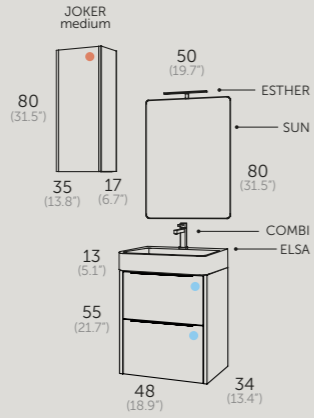

**FURNITURE**

- Glossy White
- Natural Oak
- Matte Mink

**HANDLES**

- Matte Chrome
- Matte Black
- Matte Gold

- Adjustable front.  
Einstellbare Vorderseite.  
Frontali regolabili.
- Soft close.  
Soft-close-System.  
Chiusura ammortizzata.
- Hettich sliding system.  
Korpusschiene Hettich.  
Guide Hettich.
- Soft close.  
Soft-close-System.  
Chiusura ammortizzata.



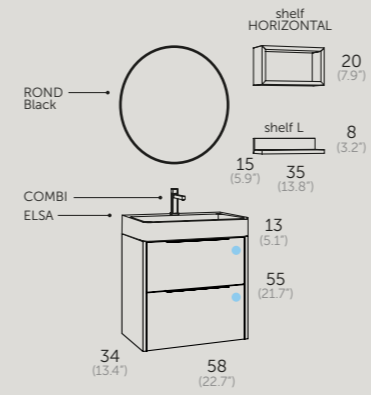

**BAMBI 60 REDUCED DEPTH**  
REDUZIERTIE TIEFE / PROFONDITÀ RIDOTTA

- 114 74 060 N Bambi 60
- 554 01 060 Elsa 60
- 244 02 060 Rond Black
- 112 47 505 Shelf Horizontal Leaf / Horizontales Regal / Scaffale Orizzontale
- 112 74 520 Shelf L Mink / Regal L / Scaffale L
- 412 25 801 Combi Black - Leaf



FURNITURE	HANDLES
Glossy White	Matte Chrome
Natural Oak	Matte Black
Matte Mink	Matte Gold

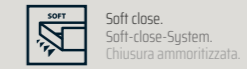
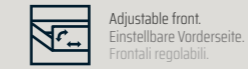

furniture / Möbel / mobili

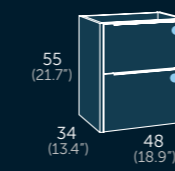

**BAMBI 50** (18.89")

- |                |                |
|----------------|----------------|
| Finishes       | Reference      |
| ● Glossy White | 114 01 050 (X) |
| ● Natural Oak  | 114 24 050 (X) |
| ● Matte Mink   | 114 74 050 (X) |

Replace the X with the handle reference:  
Ersetzen Sie das X durch die Griffreferenz:  
Sostituire la X con la referenza della maniglia:

- Chrome (C) ● Black (N) ● Gold (G)

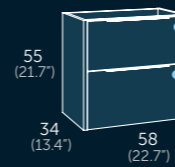

**BAMBI 60** (22.71")

- |                |                |
|----------------|----------------|
| Finishes       | Reference      |
| ● Glossy White | 114 01 060 (X) |
| ● Natural Oak  | 114 24 060 (X) |
| ● Matte Mink   | 114 74 060 (X) |

Replace the X with the handle reference:  
Ersetzen Sie das X durch die Griffreferenz:  
Sostituire la X con la referenza della maniglia:

- Chrome (C) ● Black (N) ● Gold (G)

washbasin / Waschbecken / lavabo



**ELSA ceramic**

Reference  
● Glossy White  
554 01 050

mirrors / Spiegel / specchi



**SUN**

Reference  
204 00 050

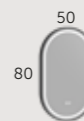

**JAZZ led**

Reference  
271 02 050

spotlights / LED Beleuchtung / lampade da parete



**NEREA MATTE 30**

Reference  
400 14 141



**ELSA ceramic**

Reference  
● Glossy White  
554 01 060



**SUN**

Reference  
204 00 060

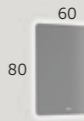

**VERONA led**

Reference  
246 00 060



**ESTHER BLACK 45**

Reference  
400 02 191

MORE OPTIONS SEE PAGES 327-434



REDUCED DEPTH

# VERSA

45 | 55



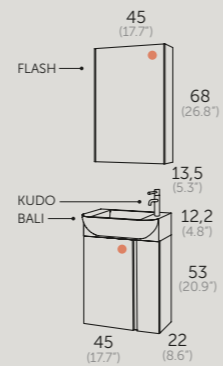

**VERSA 45**  
REDUCED DEPTH  
REDUZIERTE TIEFE / PROFONDITÀ RIDOTTA

- 145 01 045 N Versa 45
- 515 01 045 Bali 45
- 340 11 045 Flash Cabinet
- 412 02 810 Kudo Black



-  Soft close.  
Soft-close-System.  
Chiusura ammortizzata.
-  Glossy lacquered finish.  
Glänzend lackiert.  
Laccato lucido.

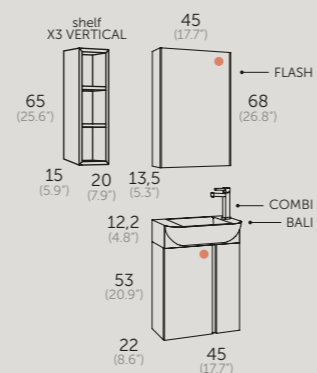

**VERSA 45** REDUCED DEPTH  
REDUZIERTE TIEFE / PROFONDITÀ RIDOTTA

- 145 47 045 C Versa 45
- 515 01 045 Bali 45
- 340 11 045 Flash Cabinet
- 112 47 500 Shelf X3 Vertical Leaf / Regal X3 Vertikal / Scaffale X3 Verticale
- 412 25 803 Combi Full Color Leaf



- HANDLES**
- Matte Chrome
  - Matte Black

- FURNITURE**
- Glossy White
  - Natural Oak
  - Matte Leaf
  - Matte Island





**VERSA 45 REDUCED DEPTH**  
REDUZIERTER TIEFE / PROFONDITÀ RIDOTTA

- 145 49 045 C Versa 45
- 515 01 045 Bali 45
- 208 00 045 Versa Mirror / Spiegel / Specchio
- 137 49 445 Joker Small Island / Klein / Piccolo
- 112 35 505 Shelf Horizontal White / Horizontales Regal / Scaffale Orizzontale
- 412 04 810 Kudo Steel

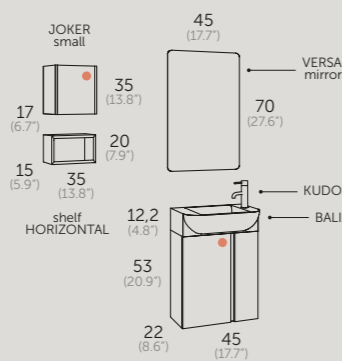

Soft close.  
Soft-close-System.  
Chiusura ammortizzata.

**FURNITURE**

- Glossy White
- Natural Oak
- Matte Leaf
- Matte Island

**HANDLES**

- Matte Chrome
- Matte Black

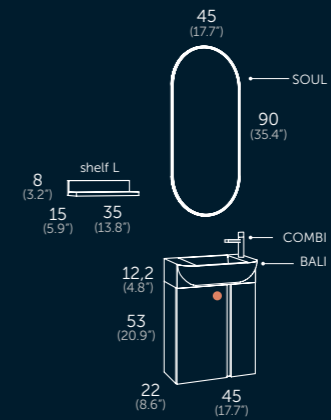
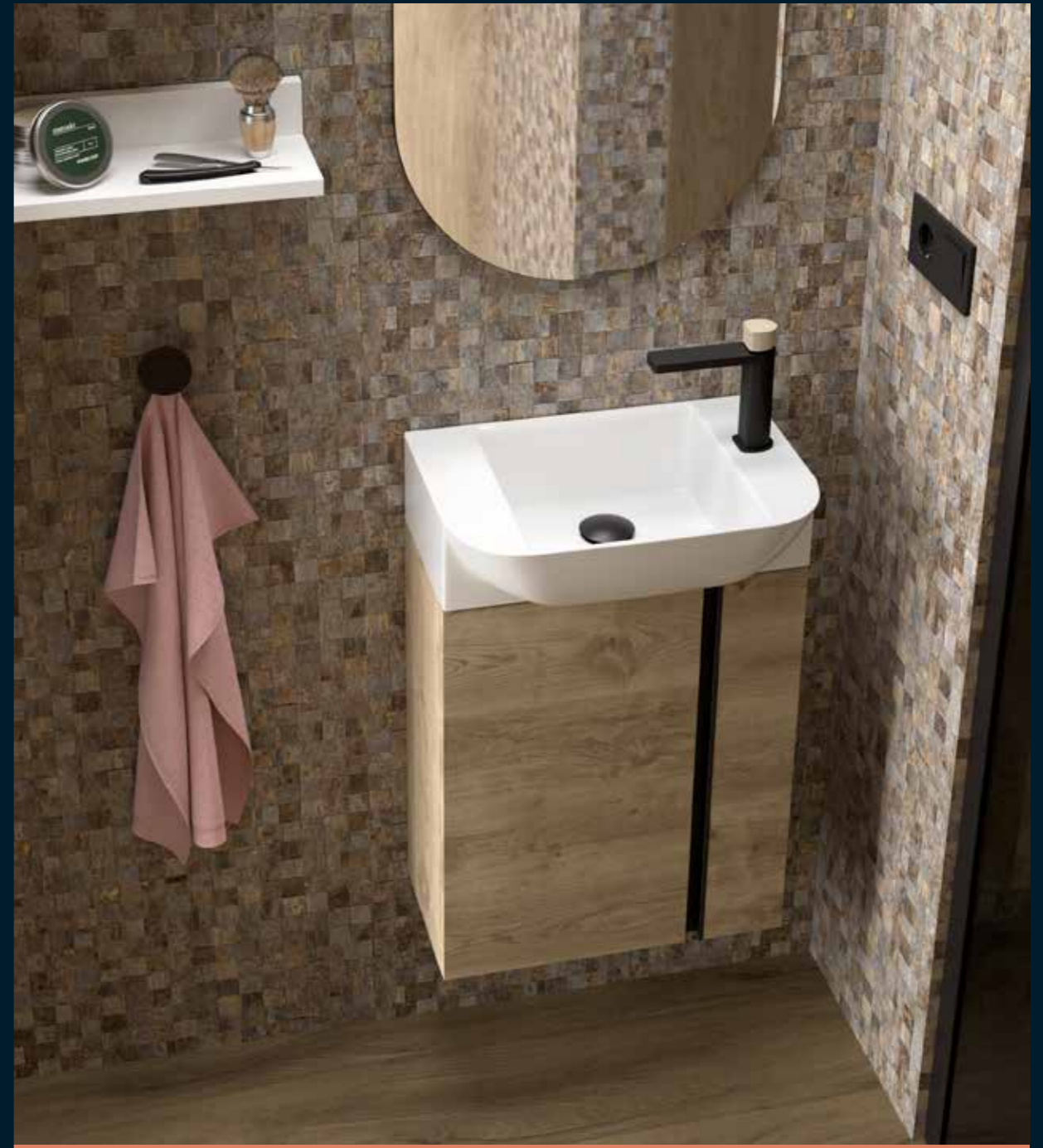

**VERSA 45 REDUCED DEPTH**  
REDUZIERTER TIEFE / PROFONDITÀ RIDOTTA

- 145 24 045 N Versa 45
- 515 01 045 Bali 45
- 239 00 090 Soul
- 112 35 520 Shelf L White / Regal L / Scaffale L
- 412 24 801 Combi Black - Natural Oak



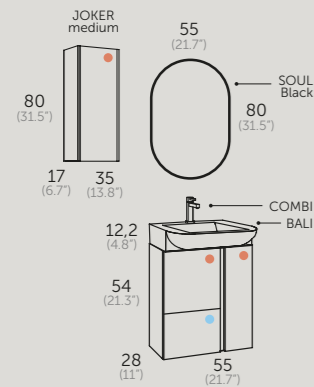



**VERSA 55 REDUCED DEPTH**  
 REDUZIERTER TIEFE / PROFONDITÀ RIDOTTA

- 145 47 055 N Versa 55
- 515 01 055 Bali 55
- 239 02 080 Soul Black
- 137 47 435 Joker Medium Leaf / Mittel / Medio
- 412 00 801 Combi Black



-  Adjustable front.  
Einstellbare Vorderseite.  
Frontali regolabili.
-  Soft close.  
Soft-close-System.  
Chiusura ammortizzata.
-  Hettich sliding system.  
Korpusschiene Hettich.  
Guide Hettich.
-  Soft close.  
Soft-close-System.  
Chiusura ammortizzata.
-  Push to open.  
Push-to-open-System.  
Sistema Push.

**FURNITURE**

- Glossy White
- Natural Oak
- Matte Leaf
- Matte Island

**HANDLES**

- Matte Chrome
- Matte Black





-  Adjustable front.  
Einstellbare Vorderseite.  
Frontali regolabili.
-  Soft close.  
Soft-close-System.  
Chiusura ammortizzata.
-  Hettich sliding system.  
Korpusschiene Hettich.  
Guide Hettich.
-  Soft close.  
Soft-close-System.  
Chiusura ammortizzata.
-  Push to open.  
Push-to-open-System.  
Sistema Push.

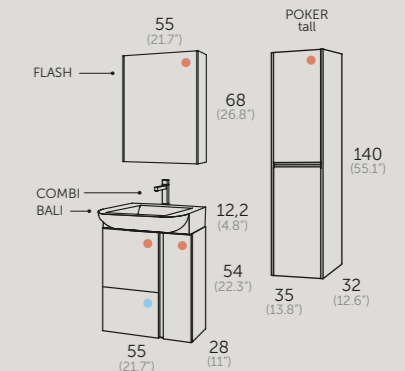

**FURNITURE**

- Glossy White
- Natural Oak
- Matte Leaf
- Matte Island

**HANDLES**

- Matte Chrome
- Matte Black

**VERSA 55 REDUCED DEPTH**  
REDUZIERTA TIEFE / PROFONDITÀ RIDOTTA

- |              |                                      |
|--------------|--------------------------------------|
| 145 24 055 C | Versa 55                             |
| 515 01 055   | Bali 55                              |
| 340 11 055   | Flash 55                             |
| 167 24 335 C | Poker Tall Natural Oak / Hoch / Alto |
| 412 00 800   | Combi Chrome                         |



furniture / Möbel / mobili

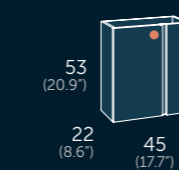

**VERSA 45** (17.71")

- | Finishes       | Reference      |
|----------------|----------------|
| ● Glossy White | 145 01 045 (X) |
| ● Natural Oak  | 145 24 045 (X) |
| ● Matte Leaf   | 145 47 045 (X) |
| ● Matte Island | 145 49 045 (X) |

Replace the X with the handle reference:  
Ersetzen Sie das X durch die Griffreferenz:  
Sostituire la X con il riferimento della maniglia:

- Chrome (C) ○ Black (N)

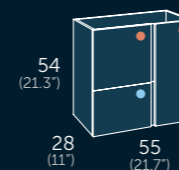

**VERSA 55** (21.65")

- | Finishes       | Reference      |
|----------------|----------------|
| ● Glossy White | 145 01 055 (X) |
| ● Natural Oak  | 145 24 055 (X) |
| ● Matte Leaf   | 145 47 055 (X) |
| ● Matte Island | 145 49 055 (X) |

Replace the X with the handle reference:  
Ersetzen Sie das X durch die Griffreferenz:  
Sostituire la X con il riferimento della maniglia:

- Chrome (C) ○ Black (N)

washbasin /  
Waschbecken /  
lavabo



**BALI ceramic**

- Reference  
● Glossy White  
515 01 045

mirrors / Spiegel / specchi



**VERSA**

- Reference  
208 00 045



**FLASH 45 cabinet**

- Reference  
● Aluminium  
340 11 045  
1 Door

spotlights



**ESTHER 30**

- Reference  
400 00 121



**BALI ceramica**

- Reference  
● Glossy White  
515 01 055

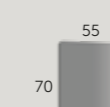

**VERSA**

- Reference  
208 00 055



**FLASH 55 cabinet**

- Reference  
● Aluminium  
340 11 055  
1 Door



**ESTHER BLACK 45**

- Reference  
400 02 191

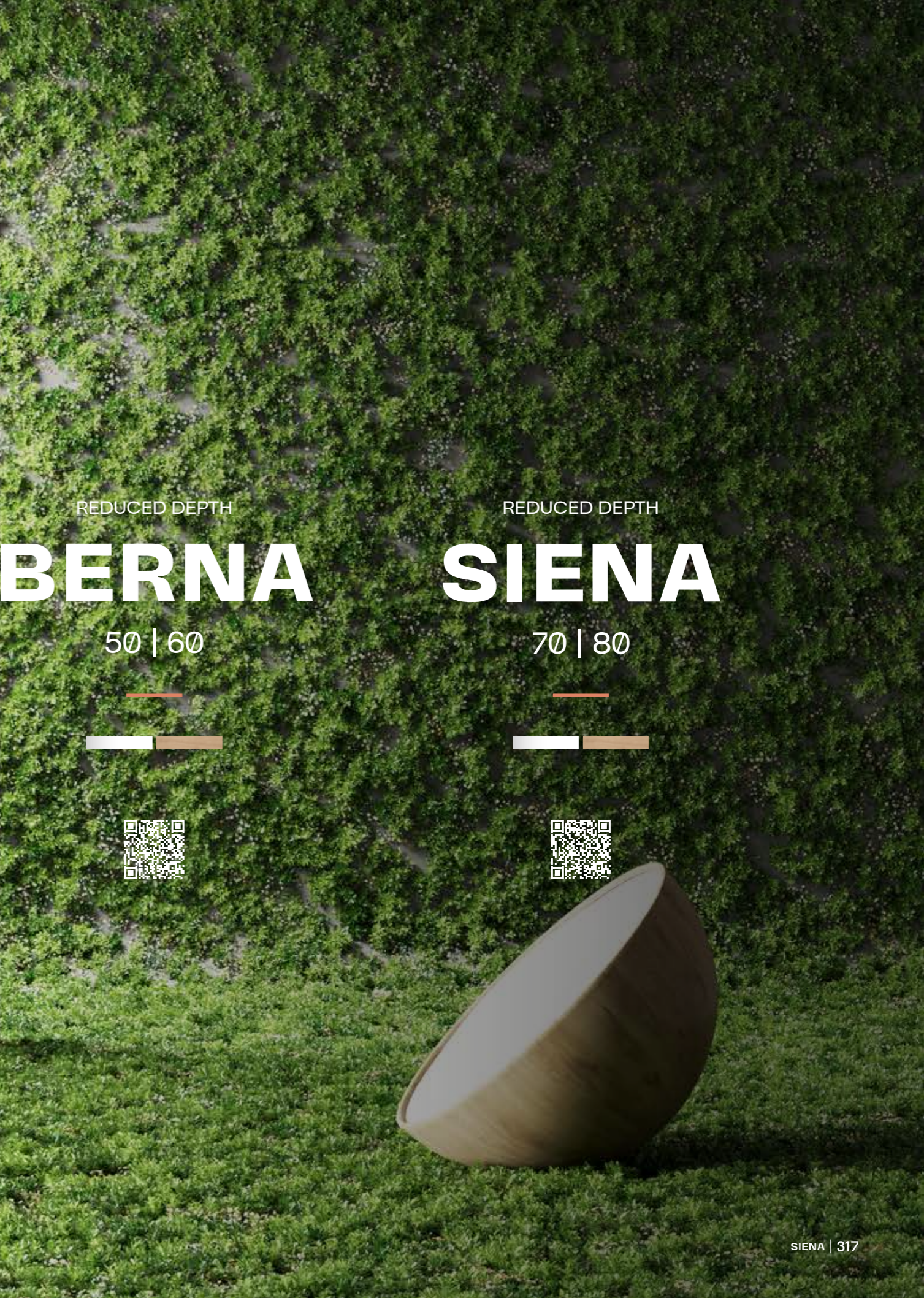

REDUCED DEPTH

# BERNA

50 | 60





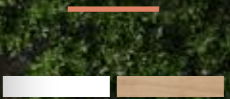

REDUCED DEPTH

# SIENA

70 | 80





-  Organizer unit. Utensilien Behälter. Organizzatore.
-  Adjustable front. Einstellbare Vorderseite. Frontali regolabili.
-  Soft close. Soft-close-System. Chiusura ammortizzata.
-  Hettich sliding system. Korpussschiene Hettich. Guide Hettich.
-  Glossy lacquered finish. Glänzend lackiert. Laccato lucido.

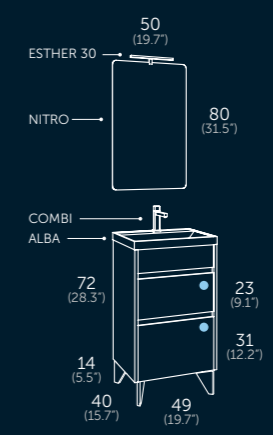

**BERNA 50 REDUCED DEPTH**  
 REDUZIERTER TIEFE / PROFONDITÀ RIDOTTA

- 140 01 050 C Berna 50
- 510 01 050 Alba 50
- 241 00 050 Nitro
- 400 00 121 Esther 30
- 412 00 800 Combi Chrome



- |  |  |
|--|--|
| <b>FURNITURE</b>   | <b>HANDLES AND LEGS</b>  |
| <input type="checkbox"/> White Glossy <input type="checkbox"/> Natural Oak | <input type="checkbox"/> Matte Chrome <input type="checkbox"/> Matte Black |

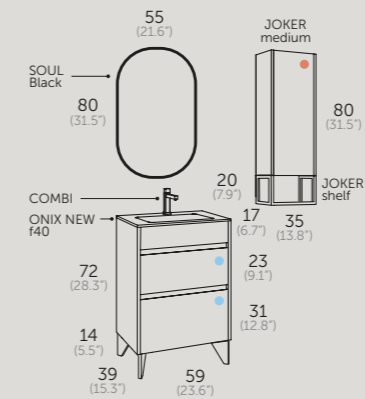

**BERNA 60 REDUCED DEPTH**  
 REDUZIERTE TIEFE / PROFONDITÀ RIDOTTA

- 140 24 060 N Berna 60
- 551 01 060 Onix New f40
- 239 02 080 Soul Black
- 137 24 435 Joker Medium Natural Oak / Mittel / Medio
- 137 24 455 Joker Shelf Natural Oak / Regal / Scaffale
- 412 24 801 Combi Black - Natural Oak



Organizer unit.  
 Utensilien Behälter.  
 Organizzatore.



Adjustable front.  
 Einstellbare Vorderseite.  
 Frontali regolabili.



Soft close.  
 Soft-close-System.  
 Chiusura ammortizzata.



Hetich sliding system.  
 Korpuschiene Hetich.  
 Guide Hetich.



Soft close.  
 Soft-close-System.  
 Chiusura ammortizzata.





**FURNITURE**

- Glossy White
- Natural Oak

**HANDLES AND LEGS**

- Matte Chrome
- Matte Black



-  Organizer unit. Utensilien Behälter. Organizzatore.
-  Adjustable front. Einstellbare Vorderseite. Frontali regolabili.
-  Soft close. Soft-close-System. Chiusura ammortizzata.
-  Hettich sliding system. Korpuschiene Hettich. Guide Hettich.
-  Glossy lacquered finish. Glänzend lackiert. Laccato lucido.

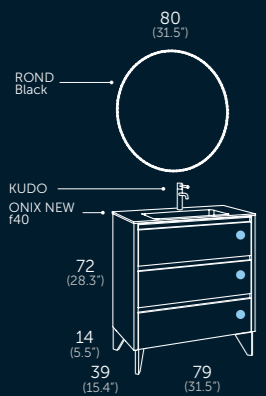

**SIENA 80 REDUCED DEPTH**  
 REDUZIERTE TIEFE / PROFONDITÀ RIDOTTA

- 144 01 080 N Siena 80
- 551 01 080 Onix New f40
- 244 02 080 Rond Black
- 412 02 810 Kudo Black



FURNITURE

- Glossy White
- Natural Oak

HANDLES AND LEGS

- Matte Chrome
- Matte Black

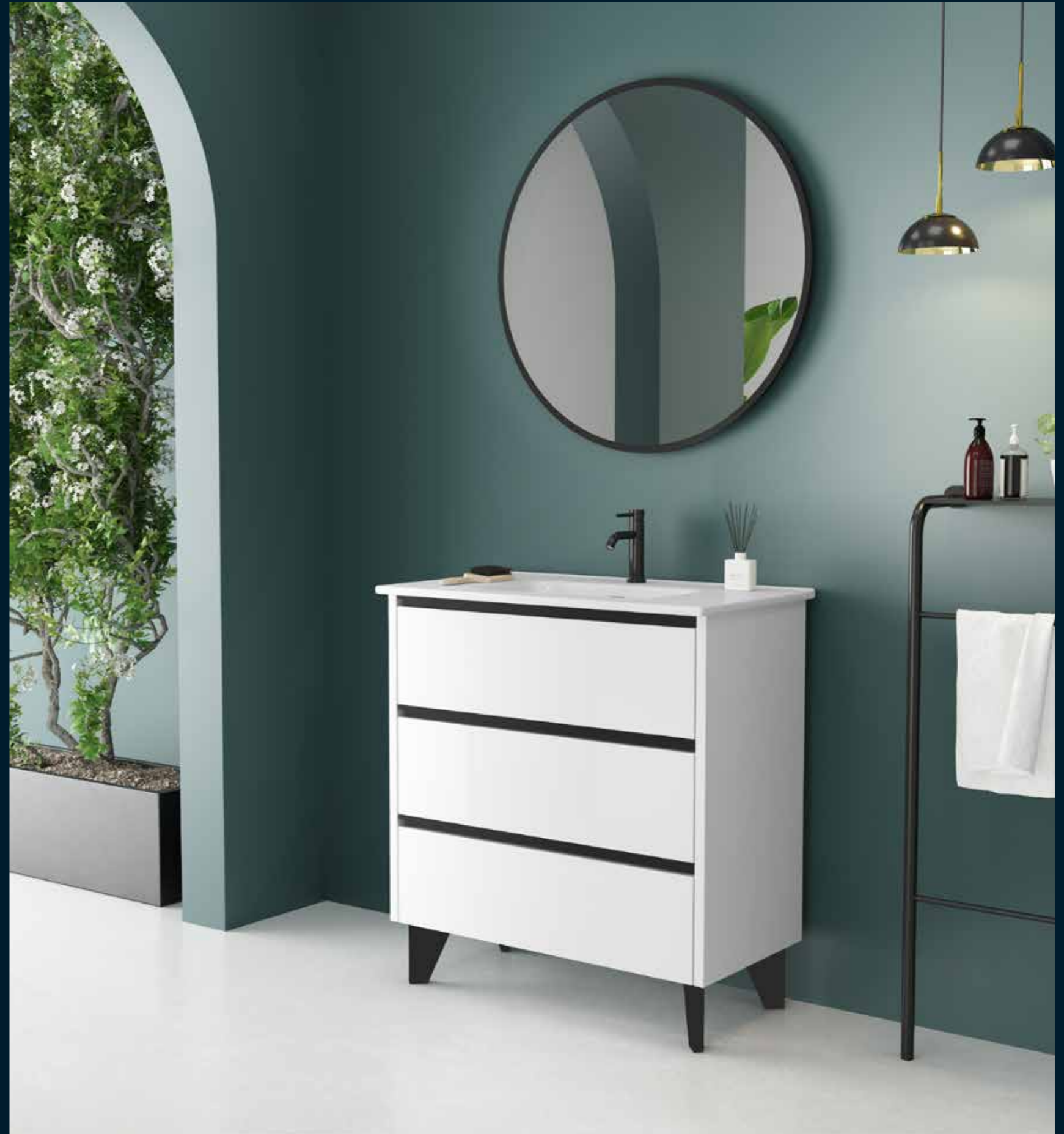



-  Organizer unit.  
Utensilien Behälter.  
Organizzatore.
-  Adjustable front.  
Einstellbare Vorderseite.  
Frontali regolabili.
-  Soft close.  
Soft-close-System.  
Chiusura ammortizzata.
-  Hettich sliding system.  
Korpusschiene Hettich.  
Guide Hettich.
-  Soft close.  
Soft-close-System.  
Chiusura ammortizzata.
-  Anti fog system.  
Anti-Beschlag-System.  
Sistema antiappannamento.
-  Ambient light.  
Umgebungslicht.  
Luce ambiente.
-  Intensity control.  
Intensitätsregler.  
Regolatore di intensità.
-  Dual sensor On/Off-anti fog.  
Doppelter Sensorschalter, On/Off.  
Doppio sensore touch, On/Off.  
Antiappannante.

### SIENA 70 REDUCED DEPTH

REDUZIERTER TIEFE / PROFONDITÀ RIDOTTA

- 144 24 070 C Siena 70
- 551 01 070 Onix New f40
- 246 00 070 Verona
- 167 24 335 C Poker Tall Natural Oak / Hoch / Alto
- 412 00 800 Combi Chrome

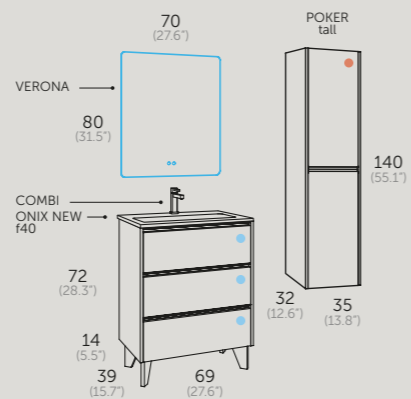

- FURNITURE**
- Glossy White
  - Natural Oak
- HANDLES AND LEGS**
- Matte Chrome
  - Matte Black

### furniture / Möbel / mobili

#### BERNA 50 (19.69")

Finishes Reference

- Glossy White 140 01 050 (X)
- Natural Oak 140 24 050 (X)

Replace the X with the colour reference of the handles and legs: Ersetzen Sie das X durch die Farbreferenz der Griffe und Beine: Sostituire la X con il riferimento colore delle maniglie e gambe:

- Chrome (C) ● Black (N)

#### BERNA 60 (23.62")

Finishes Reference

- Glossy White 140 01 060 (X)
- Natural Oak 140 24 060 (X)

Replace the X with the colour reference of the handles and legs: Ersetzen Sie das X durch die Farbreferenz der Griffe und Beine: Sostituire la X con il riferimento colore delle maniglie e gambe:

- Chrome (C) ● Black (N)

#### SIENA 70 (27.55")

Finishes Reference

- Glossy White 144 01 070 (X)
- Natural Oak 144 24 070 (X)

Replace the X with the colour reference of the handles and legs: Ersetzen Sie das X durch die Farbreferenz der Griffe und Beine: Sostituire la X con il riferimento colore delle maniglie e gambe:

- Chrome (C) ● Black (N)

#### SIENA 80 (31.49")

Finishes Reference

- Glossy White 144 01 080 (X)
- Natural Oak 144 24 080 (X)

Replace the X with the colour reference of the handles and legs: Ersetzen Sie das X durch die Farbreferenz der Griffe und Beine: Sostituire la X con il riferimento colore delle maniglie e gambe:

- Chrome (C) ● Black (N)

### side cabinets / Hängeschränke / armadi

#### POKER TALL

Finishes Reference

- Glossy White 167 01 335 (X)
- Natural Oak 167 24 335 (X)

Replace the X with the handle reference: Ersetzen Sie das X durch die Griffreferenz: Sostituire la X con il riferimento della maniglia:

- Chrome (C) ● Black (N)

Reversible opening | Umkehrbare Öffnung | Apertura reversibile

### washbasin / Waschbecken / lavabo

### mirrors / Spiegel / specchi

<b>ALBA ceramic</b>	<b>SUN</b>	<b>NITRO</b>	<b>JAZZ led</b>	<b>FLASH 45 cabinet</b>
Reference ● Glossy White 510 01 050	Reference 204 00 050	Reference 241 00 050	Reference 271 02 050	Reference ● Aluminium 340 11 045 1 Door

<b>ONIX NEW F40</b>	<b>SUN</b>	<b>RAIN led</b>	<b>AURA STRAP led</b>	<b>FLASH 60 cabinet</b>
Reference ● Glossy White 551 01 060 ● Matte Colour 553 XX 060	Reference 204 00 060	Reference 269 00 060	Reference 251 02 060	Reference ● Aluminium 340 11 060 1 Door

<b>ONIX NEW F40</b>	<b>SUN</b>	<b>RAIN led</b>	<b>AURA led</b>	<b>FLASH 70 cabinet</b>
Reference ● Glossy White 551 01 070 ● Matte Colour 553 XX 070	Reference 204 00 070	Reference 269 00 070	Reference 250 02 070	Reference ● Aluminium 340 11 070 2 Doors

<b>ONIX NEW F40</b>	<b>SUN</b>	<b>RAIN led</b>	<b>AURA led</b>	<b>FLASH 80 cabinet</b>
Reference ● Glossy White 551 01 080 ● Matte Colour 553 XX 080	Reference 204 00 080	Reference 269 00 080	Reference 250 02 080	Reference ● Aluminium 340 11 080 2 Doors

### accessories / Zubehör / complementi

#### JOKER MEDIUM

Finishes Reference

- White Glossy 137 01 435
- Natural Oak 137 24 435

Reversible opening | Umkehrbare Öffnung | Apertura reversibile

#### JOKER SMALL

Finishes Reference

- White Glossy 137 01 445
- Natural Oak 137 24 445

Reversible opening | Umkehrbare Öffnung | Apertura reversibile

Replace the **XX** by the chosen colour code. See codes on page 447.  
Ersetzen Sie **XX** durch den Code der ausgewählten Farbe. Siehe Seite 447 für Farbcodes.  
Sostituire l'**XX** con il codice colore scelto. Vedere i codici a pagina 447.

MORE OPTIONS SEE PAGES 327-434

# SOLID SURFACE

---

New formats, sizes, and models expand this Solid Surface collection, offering unique versatility to adapt to any setting. Coycama's Solid Surface stands out for its high-quality materials. Our exclusive formula achieves a luminous white and a silky matte surface, hallmarks of the purest Solid Surface, without the need for additional coatings.

Neue Formate, Größen und Modelle erweitern diese Kollektion von Solid Surface und bieten eine einzigartige Vielseitigkeit, um sich an jede Umgebung anzupassen. Das Solid Surface von Coycama zeichnet sich durch hochwertige Materialien aus. Unsere exklusive Formel erreicht ein leuchtendes Weiß und eine seidige matte Oberfläche, die Merkmale der reinsten Solid Surface, ganz ohne zusätzliche Beschichtungen.

Nuovi formati, dimensioni e modelli ampliano questa collezione di Solid Surface, offrendo una versatilità unica per adattarsi a qualsiasi ambiente. Il Solid Surface di Coycama si distingue per i suoi materiali di alta qualità. La nostra formula esclusiva raggiunge un bianco luminoso e una superficie opaca setosa, tratti distintivi del Solid Surface più puro, senza la necessità di rivestimenti aggiuntivi.





Ambar washbasin, f46, 2 sinks (custom-made). 201 cm.

WASHBASIN / WASCHBECKEN / LAVABO  
**AMBAR**

Ambar washbasin, f46, 1 sink. 81 cm.

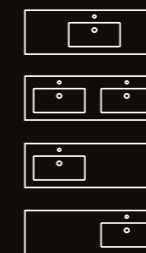

PLINTHED WASHBASIN / WASCHBECKEN / LAVABO  
**AMBAR**

Ambar plinthed washbasin 10 cm, f46, 1 sink. **100 cm.**



Ambar plinthed washbasin 10 cm, f46, 1 sink with towel rail, without tap drilling. **140 cm.**



Ambar plinthed washbasin 16 cm, f50, 1 sink "XL" with overflow (custom-made), 160 cm.

CUSTOM-MADE / MASSGESCHNEIDERT / SU MISURA  
**AMBAR**

Ambar washbasin f41, 2 sinks "XS" (custom-made), 120 cm



WALL MOUNTED WASHBASIN /  
 WASCHTISCHPLATTEBECKEN / LAVABO A MURO  
**AMBAR**

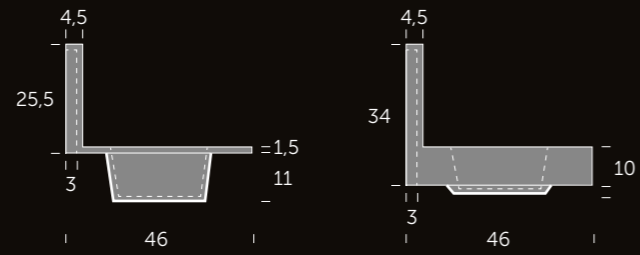

Ambar Wall-Mounted plinth washbasin 10 cm, 2 sinks. 140 (70+70) cm



Ambar Wall-Mounted washbasin, 1 sink. 101 cm.



COUNTERTOPS / WASCHTISCHPLATTE / PIANO  
**AMBAR**

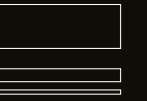

Ambar countertop, f46, with towel rail. **121 cm**. Oval Countertop basin.



WASHBASIN / WASCHBECKEN / LAVABO  
**ZAFIRO**

Zafiro washbasin, 1 sink. 100 cm.



Zafiro washbasin, 2 sinks. 120 cm.





Zen plinthead washbasin 10 cm, f46, 2 sinks, without tap drilling. 120 (60+60) cm.

Zen washbasin, f46, 1 sink. 101 cm.

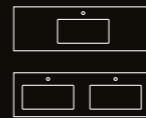

CUSTOM-MADE / NACH MAß / SU MISURA  
**ZEN**

Ambar plinthed washbasin 15 cm, f50, 1 sink (custom-made). 140 cm.



Ambar washbasin, f46, 2 sinks (custom-made). 141 cm.

COUNTERTOP BASIN / AUFSATZWASCHBECKEN / LAVABO DA APPOGGIO  
**SOLID SURFACE**



**OVAL**  
57 x 41 x 11

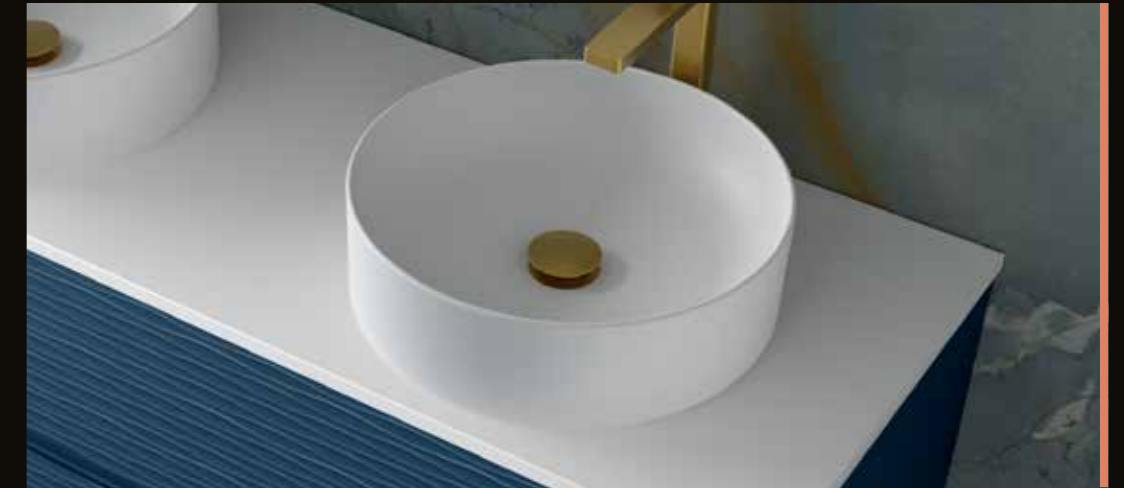

**ATENAS**  
Ø37 x 11



**MILOS**  
51 x 33 x 11



**CORINTO**  
37 x 37 x 12



**ZANTE**  
51 x 35 x 10



**MYKONOS**  
51 x 34 x 11

# AMBAR DEPTH 46 cm.

# SOLID SURFACE

It comes with tap drilling. Option without drilling, faucet available on request. Add (G) to the reference.  
Es wird mit Bohrung für den Wasserhahn geliefert. Option ohne Bohrung, Wasserhahn auf Anfrage. Fügen Sie (G) zur Referenz hinzu.  
Viene fornito con foratura per il rubinetto. Opzione senza foratura, rubinetto su richiesta. Aggiungere (G) alla referenza.

• **IN STOCK** (rest of the items available on request).

## WASHBASIN

Height: 15 cm



**1 SINK CENTRED**

cm	Reference
61	506 01 060
71	506 01 070
81	506 01 080
101	506 01 100
121	506 01 120



**1 SINK LEFT**

cm	Reference
81 (60+20)	506 01 081
91 (70+20)	506 01 092
101 (70+30)	506 01 107
111 (80+30)	506 01 112
121 (60+60)	506 01 121
141 (70+70)	506 01 143



**1 SINK RIGHT**

cm	Reference
81 (20+60)	506 01 083
91 (20+70)	506 01 094
101 (30+70)	506 01 108
111 (30+80)	506 01 114
121 (60+60)	506 01 123
141 (70+70)	506 01 144



**2 SINKS**

cm	Reference
121 (60+60)	506 01 122
141 (70+70)	506 01 142
161 (80+80)	506 01 162

**MOVABLE SINKS**

**1 SINK** 602 01 001  
cm from 61 to 201

**2 SINKS** 602 01 002  
cm from 121 to 201

For custom-made washbasins, it is essential to provide a plan detailing the drain positions. A minimum margin of 6.5 cm must be maintained between the side and the sink or between the sinks of the washbasin.



Minimum margin: 6.5 cm  
Mindestabstand: 6,5 cm  
Margine minimo: 6,5 cm

**SINK MEASUREMENT**

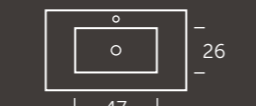

Sink depth: 10 cm  
Tiefen des Waschbeckens: 10 cm  
Profondità del lavabo: 10 cm

It comes undrilled. Es wird unvorbereitet geliefert. Viene non forato.

## COUNTERTOP

Height: 12 cm  
Reinforcement Bar required.



cm	Reference
61	508 01 060
71	508 01 070
81	508 01 080
101	508 01 100
121	508 01 120
141	508 01 140
161	508 01 160
181	508 01 180
201	508 01 200

**MOVABLE SINKS**

**1 SINK** 602 01 001  
cm from 61 to 201

**2 SINKS** 602 01 002  
cm from 121 to 201

For custom-made washbasins, it is essential to provide a plan detailing the drain positions. A minimum margin of 6.5 cm must be maintained between the side and the sink or between the sinks of the washbasin.



Minimum margin: 6.5 cm  
Mindestabstand: 6,5 cm  
Margine minimo: 6,5 cm

**SINK MEASUREMENT**

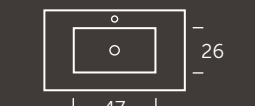

Sink depth: 10 cm  
Tiefen des Waschbeckens: 10 cm  
Profondità del lavabo: 10 cm

It comes undrilled. Es wird unvorbereitet geliefert. Viene non forato.

## WALL-MOUNTED

Height: 25.5 cm



cm	Reference
61	526 01 060
71	526 01 070
81	526 01 080
101	526 01 100
121 1s centred	526 01 120
121 2s (60+60)	526 01 122
141 1s centred	526 01 140
141 2s (70+70)	526 01 142

**MOVABLE SINKS**

**1 SINK** 603 01 001  
cm from 60 to 200

**2 SINKS** 603 01 002  
cm from 120 to 200

For custom-made washbasins, it is essential to provide a plan detailing the drain positions. A minimum margin of 6.5 cm must be maintained between the side and the sink or between the sinks of the washbasin.



Minimum margin: 6.5 cm  
Mindestabstand: 6,5 cm  
Margine minimo: 6,5 cm

**SINK MEASUREMENT**



Sink depth: 10 cm  
Tiefen des Waschbeckens: 10 cm  
Profondità del lavabo: 10 cm

**DRILLING SERVICE** Plan required  
Ref: 435 00 050

Countertops, plinthed countertops and wall-mounted washbasins are supplied without drilling. Easily drillable with a woodworker's crown drill bit. Abdeckung, plinthe Abdeckung und wandmontierte Waschbecken werden ohne Bohrungen geliefert. Einfach mit einem Holzbohrerkrone-Bohrer zu bohren. Piano, piano con gonn e lavabi a parete sono forniti senza fori. Facile da forare con una punta a corona da falegname.

**INTEGRATED TOWEL RAIL**  
Extension 10 cm with cut. / Erweiterung 10 cm mit Schnitt. / Estensione 10 cm con taglio.



**REINFORCEMENT BAR FOR COUNTERTOP**

To avoid deformation of the countertops, it is necessary to install the reinforcement bar in the module where the washbasin will be supported. Um Verformungen der Abdeckung zu vermeiden, ist es notwendig, die Verstärkungsstange im Modul zu installieren, in dem das Waschbecken unterstützt wird. Per evitare deformazioni del top, è necessario installare la barra di rinforzo nel modulo in cui sarà supportato il lavabo.

cm	Reference
60	425 14 060
70	425 14 070
80	425 14 080
90	425 14 090
100	425 14 100
120	425 14 120

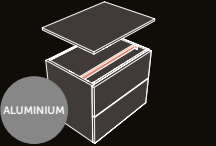

## PLINTHED WASHBASIN

Plinth height: 10 cm | For plinths from 11 to 20 cm, see page 383



**1 SINK CENTRED**

cm	Reference
60	524 01 060
70	524 01 070
80	524 01 080
100	524 01 100
120	524 01 120



**1 SINK LEFT**

cm	Reference
80 (60+20)	524 01 081
90 (70+20)	524 01 092
100 (70+30)	524 01 101
110 (80+30)	524 01 111
120 (60+60)	524 01 121
140 (70+70)	524 01 141



**1 SINK RIGHT**

cm	Reference
80 (20+60)	524 01 083
90 (20+70)	524 01 094
100 (30+70)	524 01 103
110 (30+80)	524 01 113
120 (60+60)	524 01 123
140 (70+70)	524 01 143



**2 SINKS**

cm	Reference
120 (60+60)	524 01 122
140 (70+70)	524 01 142
160 (80+80)	524 01 162

**MOVABLE SINKS**

**1 SINK** 603 01 001  
cm from 60 to 200

**2 SINKS** 603 01 002  
cm from 120 to 200

For custom-made washbasins, it is essential to provide a plan detailing the drain positions. A minimum margin of 6.5 cm must be maintained between the side and the sink or between the sinks of the washbasin.



Minimum margin: 6.5 cm  
Mindestabstand: 6,5 cm  
Margine minimo: 6,5 cm

**SINK MEASUREMENT**

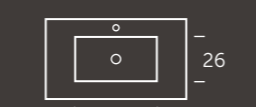

Sink depth: 10 cm  
Tiefen des Waschbeckens: 10 cm  
Profondità del lavabo: 10 cm

**PLINTHED COUNTERTOP**

Plinth height: 10 cm  
For plinths from 11 to 20 cm, see page 383



cm	Reference
60	525 01 060
70	525 01 070
80	525 01 080
100	525 01 100
120	525 01 120
140	525 01 140
160	525 01 160
180	525 01 180
200	525 01 200

**MOVABLE SINKS**

**1 SINK** 603 01 001  
cm from 60 to 200

**2 SINKS** 603 01 002  
cm from 120 to 200

For custom-made washbasins, it is essential to provide a plan detailing the drain positions. A minimum margin of 6.5 cm must be maintained between the side and the sink or between the sinks of the washbasin.



Minimum margin: 6.5 cm  
Mindestabstand: 6,5 cm  
Margine minimo: 6,5 cm

**SINK MEASUREMENT**

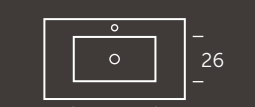

Sink depth: 10 cm  
Tiefen des Waschbeckens: 10 cm  
Profondità del lavabo: 10 cm

**PLINTHED WALL-MOUNTED**

Total height: 34 cm - Plinth height: 10 cm



cm	Reference
60	527 01 060
70	527 01 070
80	527 01 080
100	527 01 100
120 1s centred	527 01 120
120 2s (60+60)	527 01 122
140 1s centred	527 01 140
140 2s (70+70)	527 01 142

**MOVABLE SINKS**

**1 SINK** 603 01 001  
cm from 60 to 200

**2 SINKS** 603 01 002  
cm from 120 to 200

For custom-made washbasins, it is essential to provide a plan detailing the drain positions. A minimum margin of 6.5 cm must be maintained between the side and the sink or between the sinks of the washbasin.



Minimum margin: 6.5 cm  
Mindestabstand: 6,5 cm  
Margine minimo: 6,5 cm

**SINK MEASUREMENT**



Sink depth: 10 cm  
Tiefen des Waschbeckens: 10 cm  
Profondità del lavabo: 10 cm

**TOWEL RAIL PLINTH**

Centred placement in the sink. Provide a plan if a different position is desired. Not available for the ZEN model. Zentrierte Platzierung im Waschbecken. Ein Plan muss bereitgestellt werden, wenn eine andere Position gewünscht wird. Nicht verfügbar für das ZEN-Modell. Posizionamento centrato nel lavabo. Fornire un piano se si desidera una posizione diversa. Non disponibile per il modello ZEN.

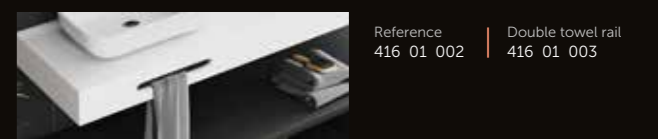

Reference	Double towel rail
416 01 002	416 01 003

**INVISIBLE BRACKETS**

Support systems with leveling adjustments and screws included for wall-mounted basins, countertops, and plinthead countertops. Two sets are included for sizes equal to or greater than 140 cm. Unterstützungssysteme mit Höhenverstellung und Schrauben für wandhängende Waschbecken, Waschtische und plinthead Waschtische. Zwei Sets sind bei Größen von 140 cm oder mehr enthalten. Sistemi di supporto con regolazioni di livello e viti inclusi per lavabi sospesi, piani lavabo e lavabi plintati. Due set sono inclusi per dimensioni pari o superiori a 140 cm.

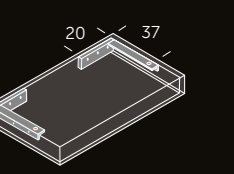
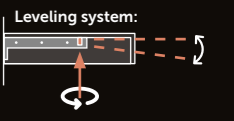

For overflow, ornament, and more customization options. Für überlauf, ornament und weitere Anpassungsoptionen. Per sovrapposizione, ornamento e altre opzioni di personalizzazione. see page 383.

# AMBAR | CUSTOM-MADE

## DEPTHS from 40 to 60 cm.

SOLID SURFACE

### AMBAR SINKS

#### SINKS MEASUREMENTS

**XS**

Sink depth: 8.5 cm  
Waschbecken-Tiefe: 8.5 cm  
Profondità del lavabo: 8.5 cm

**Washbasin depth: from 40 to 45 cm**  
Optional for depths up to 60 cm.  
Optional für Tiefen bis zu 60 cm.  
Opzionale per profondità fino a 60 cm.

**M**

Sink depth: 10 cm  
Waschbecken-Tiefe: 10 cm  
Profondità del lavabo: 10 cm

**Washbasin depth: from 46 to 49 cm**  
Optional for depths from 50 to 60 cm.  
Optional für Tiefen von 50 bis 60 cm.  
Opzionale per profondità da 50 a 60 cm.

**XL**

Sink depth: 10 cm  
Waschbecken-Tiefe: 10 cm  
Profondità del lavabo: 10 cm

**Washbasin depth: from 50 to 60 cm**  
Waschbecken-Tiefe: von 50 bis 60 cm  
Profondità del lavabo: da 50 a 60 cm

Minimum margin: 6.5 cm  
Mindestabstand: 6.5 cm  
Margine minimo: 6.5 cm

For custom-made washbasins, plinthed washbasins it is essential to provide a plan detailing the drain positions. A minimum margin of 6.5 cm must be maintained between the side and the sink or between the sinks of the washbasin.

Für maßgefertigte Waschbecken und Waschbecken mit plinthe ist es unerlässlich, einen Plan mit den Positionen der Abflüsse bereitzustellen. Ein Mindestabstand von 6,5 cm muss zwischen der Seite und dem Waschbecken oder zwischen den Waschbecken des Möbels eingehalten werden.

Per lavabi su misura e lavabi con faldone, è essenziale fornire un piano che dettagli le posizioni dei drenaggi. Deve essere mantenuto un margine minimo di 6,5 cm tra il lato e il lavabo o tra i lavabi del mobile.

### WASHBASIN

Height: 1,5 cm

**1 SINK MOVABLE**

60 to 201 cm

Depth	40 cm	to 50 cm	to 60 cm
ref	600 01 001	604 01 001	606 01 001

**\*Measure 60:** Available only for depths up to 49 cm.  
**\*\*Measure 60 to 71:** For depths from 50 cm, the minimum width is 65 cm.

**\*Maß 60:** Nur für Tiefen bis 49 cm verfügbar.  
**\*\*Maß 60 bis 71:** Für Tiefen ab 50 cm beträgt die Mindestbreite 65 cm.

**\*Misura 60:** Disponibile solo per profondità fino a 49 cm.  
**\*\*Misura 60 a 71:** Per profondità superiori a 50 cm, la larghezza minima è di 65 cm.

**1 SINK (XS) 51 X 41 CM**

ref 600 01 051

**2 SINKS MOVABLE**

121 to 201 cm

Depth	40 cm	to 50 cm	to 60 cm
ref	600 01 002	604 01 002	606 01 002

**CUSTOM-MADE**

### PLINTHED WASHBASIN

Plinth height: 10 cm | For plinths from 11 to 20 cm, see page 383

**1 SINK MOVABLE**

60 to 200 cm

Depth	40 cm	to 50 cm	to 60 cm
ref	601 01 001	605 01 001	607 01 001

**\*Measure 60:** Available only for depths up to 49 cm.  
**\*\*Measure 60 to 70:** For depths from 50 cm, the minimum width is 65 cm.

**\*Maß 60:** Nur für Tiefen bis 49 cm verfügbar.  
**\*\*Maß 60 bis 70:** Für Tiefen ab 50 cm beträgt die Mindestbreite 65 cm.

**\*Misura 60:** Disponibile solo per profondità fino a 49 cm.  
**\*\*Misura 60 a 70:** Per profondità superiori a 50 cm, la larghezza minima è di 65 cm.

**2 SINKS MOVABLE**

120 to 200 cm

Depth	40 cm	to 50 cm	to 60 cm
ref	601 01 002	605 01 002	607 01 002

**CUSTOM-MADE**

### COUNTERTOPS

Height: 1.2 cm

Reinforcement Bar required / Verstärkungsstab erforderlich / Barra di rinforzo necessaria

Depth	40 cm	to 50 cm	to 60 cm
ref	610 01 000	614 01 000	616 01 000

**\*Measure 51:** Depth 41 cm  
**\*Maß 51:** Tiefe 41 cm  
**\*Misura 51:** Profondità 41 cm

**CUSTOM-MADE**

### PLINTHED COUNTERTOPS

Plinth height: 10 cm | For plinths from 11 to 20 cm, see page 383

Depth	40 cm	to 50 cm	to 60 cm
ref	611 01 000	615 01 000	617 01 000

**\*Measure 50:** Depth 41 cm  
**\*Maß 50:** Tiefe 41 cm  
**\*Misura 50:** Profondità 41 cm

**CUSTOM-MADE**

### DRILLING SERVICE

Plan required  
Ref: 435 00 050

Countertops, plinthed countertops and wall-mounted washbasins are supplied without drilling. Easily drillable with a woodworker's crown drill bit. Abdeckung, plinthe Abdeckung und wandmontierte Waschbecken werden ohne Bohrungen geliefert. Einfach mit einem Holzbohrerkrone-Bohrer zu bohren. Piano, piano con gonna e lavabi a parete sono forniti senza fori. Facile da forare con una punta a corona da falegname.

### INTEGRATED TOWEL RAIL

Extension 10 cm with cut. / Erweiterung 10 cm mit Schnitt. / Estensione 10 cm con taglio.

### REINFORCEMENT BAR FOR COUNTERTOP

To avoid deformation of the countertops, it is necessary to install the reinforcement bar in the module where the washbasin will be supported. Um Verformungen der Abdeckung zu vermeiden, ist es notwendig, die Verstärkungsstange im Modul zu installieren, in dem das Waschbecken unterstützt wird. Per evitare deformazioni dei top, è necessario installare la barra di rinforzo nel modulo in cui sarà supportato il lavabo.

cm	Reference
60	425 14 060
70	425 14 070
80	425 14 080
90	425 14 090
100	425 14 100
120	425 14 120

ALUMINIUM

### TOWEL RAIL PLINTH

Centred placement in the sink. Provide a plan if a different position is desired. Zentrierte Platzierung im Waschbecken. Ein Plan muss bereitgestellt werden, wenn eine andere Position gewünscht wird. Nicht verfügbar für das ZEN-Modell. Posizionamento centrato nel lavabo. Fornire un piano se si desidera una posizione diversa. Non disponibile per il modello ZEN.

Reference	Double towel rail
416 01 002	416 01 003

### INVISIBLE BRACKETS

Support systems with leveling adjustments and screws included for wall-mounted basins, countertops, and plinthed countertops. Two sets are included for sizes equal to or greater than 140 cm. Unterstützungssysteme mit Höhenverstellung und Schrauben für wandhängende Waschbecken, Waschtische und plinthed Waschtische. Zwei Sets sind bei Größen von 140 cm oder mehr enthalten. Sistemi di supporto con regolazioni di livello e viti inclusi per lavabi sospesi, piani lavabo e lavabi plintati. Due set sono inclusi per dimensioni pari o superiori a 140 cm.

For overflow, ornament, and more customization options. Für überlauf, ornament und weitere anpassungsoptionen. Per sovrappressione, ornamento e altre opzioni di personalizzazione, see page 383.

# ZEN

DEPTH **46** cm.

• **IN STOCK**  
(rest of the items available on request).



## WASHBASIN

Height: 1.5 cm



### 1 SINK CENTRED

cm	Reference
• 61	555 01 060
• 81	555 01 080
• 101	555 01 100
• 121	555 01 120

### 2 SINKS

cm	Reference
• 121 (60+60)	555 01 122

### 1 SINK MOVABLE

1 SINK	cm	Reference
	620 01 001	from 61 to 201

### 2 SINK MOVABLE

2 SINKS	cm	Reference
	620 01 002	from 121 to 201

Overflow option not available.  
/ Überlaufoption nicht verfügbar.  
/ Opzione di troppopieno non disponibile.

# ZEN CUSTOM - MADE

DEPTHS from **47** to **60** cm.



## WASHBASIN

Height: 1.5 cm

### 1 SINK MOVABLE



Depth	47 - 50 cm	to 60 cm
ref	622 01 001	624 01 001

### 2 SINKS MOVABLE



Depth	47 - 50 cm	to 60 cm
ref	622 01 002	624 01 002

Overflow option not available.  
/ Überlaufoption nicht verfügbar.  
/ Opzione di troppopieno non disponibile.

CUSTOM-MADE

## ZEN SINK

### SINK MEASUREMENT

Depth: 9 cm / Tiefe: 9 cm / Profondità: 9 cm

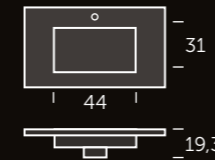

Minimum margin: 8 cm  
Mindestabstand: 8 cm  
Margine minimo: 8 cm



For custom-made washbasins, plinthed washbasins it is essential to provide a plan detailing the drain positions. A minimum margin of 8 cm must be maintained between the side and the sink or between the sinks of the washbasin.

Für maßgefertigte Waschbecken und Waschbecken mit Plinthe ist es unerlässlich, einen Plan mit den Positionen der Abflüsse bereitzustellen. Ein Mindestabstand von 8 cm muss zwischen der Seite und dem Waschbecken oder zwischen den Waschbecken des Möbels eingehalten werden.

Per lavabi su misura e lavabi con faldone, è essenziale fornire un piano che dettagli le posizioni dei drenaggi. Deve essere mantenuto un margine minimo di 8 cm tra il lato e il lavabo o tra i lavabi del mobile.

### INVISIBLE BRACKETS

Support systems with leveling adjustments and screws included for wall-mounted basins. Two sets are included for sizes equal to or greater than 140 cm.

Unterstützungssysteme mit Höhenverstellung und Schrauben für wandhängende Waschbecken. Zwei Sets sind bei Größen von 140 cm oder mehr enthalten.

Sistemi di supporto con regolazioni di livello e viti inclusi per lavabi sospesi. Due set sono inclusi per dimensioni pari o superiori a 140 cm.

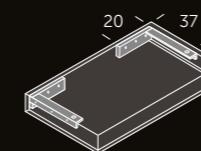

### Leveling system:

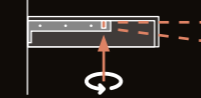

For ornament, and more customization options. Für ornament und weitere Anpassungsoptionen. Per ornamento e altre opzioni di personalizzazione. see page 383.

# SOLID SURFACE

## ZAFIRO



Depth: 46 cm | Height: 10 cm

### Wall-Mounted

cm	Reference
• 60	531 01 060
• 80	531 01 080
• 100 1 Tap	531 01 100
• 100 2 Taps	531 01 102
• 120 1 Tap	531 01 120
• 120 2 Taps	531 01 122

### ZAFIRO SINK

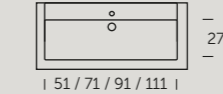

Fondo: 41 cm | Height: 10 cm

### Wall-Mounted or Countertop basins

cm	Reference
• 50	531 01 050

### ZAFIRO f40 SINK

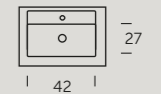

They are supplied with a tap hole. Option without drilling, add (G) to the reference. Overflow option available. Sie werden mit einem Hahnloch geliefert. Option ohne Bohrung: Fügen Sie (G) zur Referenz hinzu. Überlaufoption verfügbar. Sono forniti con foro per il rubinetto. Opzione senza foratura: aggiungere (G) alla referenza. Opzione con troppo pieno disponibile.

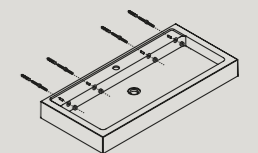

INSTALLATION SYSTEM INCLUDED.

## COUNTERTOP BASINS



### OVAL

cm	Reference
• 57x41x11	509 01 001



### ATENAS

cm	Reference
• ø37x11	580 01 037



### MILOS

cm	Reference
• 51x33x11	509 01 052



### MYKONOS

cm	Reference
• 51x34x11	584 01 034



### CORINTO

cm	Reference
• 37x37x12	582 01 037



### ZANTE

cm	Reference
• 51x35x10	559 01 050

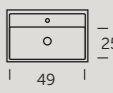

It comes with tap drilling. Option without drilling, faucet available on request. Add (G) to the reference. Es wird mit Bohrung für den Wasserhahn geliefert. Option ohne Bohrung, Wasserhahn auf Anfrage. Fügen Sie (G) zur Referenz hinzu. Viene fornito con foratura per il rubinetto. Opzione senza foratura, rubinetto su richiesta. Aggiungere (G) alla referenza.

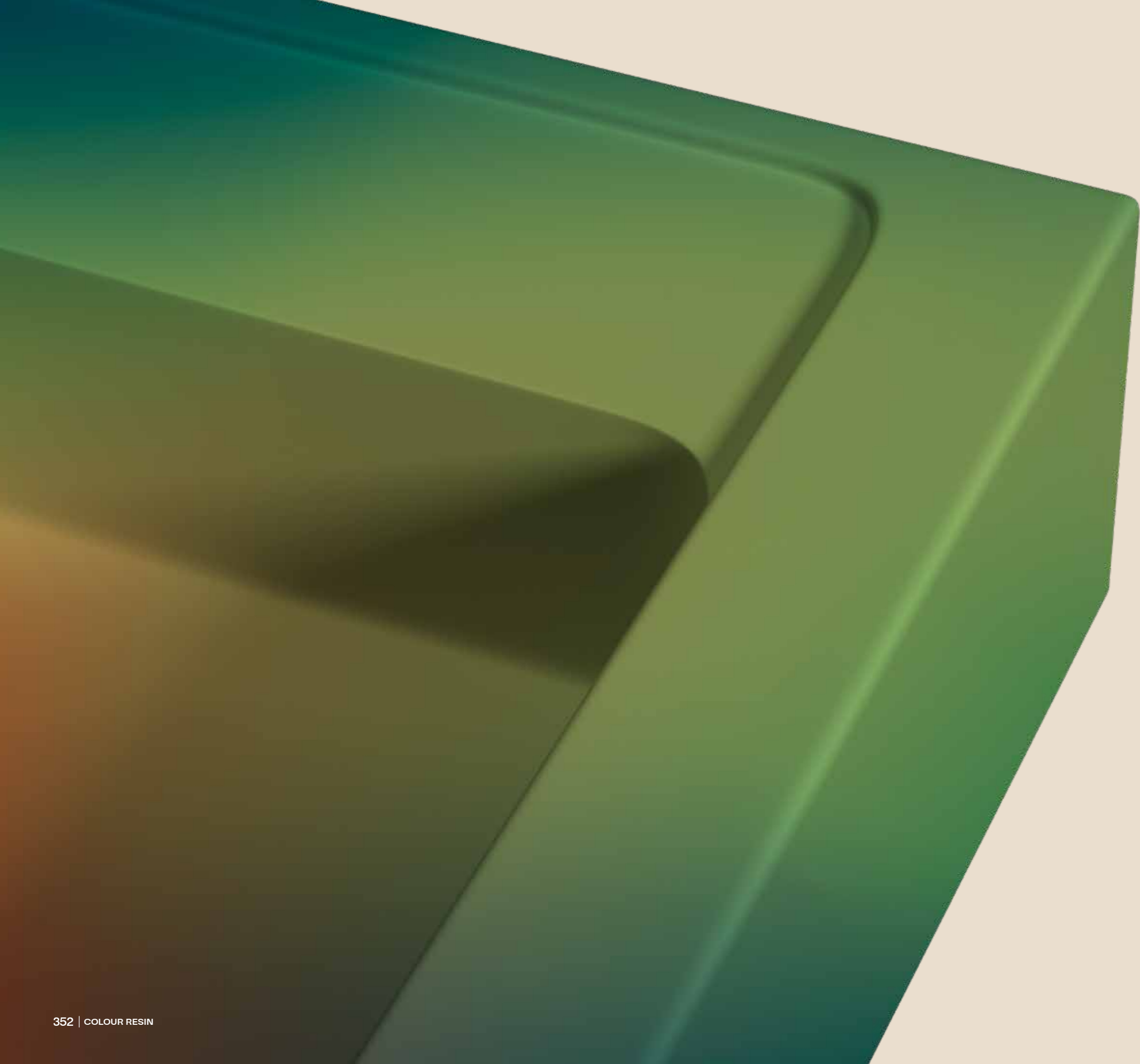

# COLOUR RESIN

Discover new models and configuration options, and add colour to your bathroom with an exclusive selection of finishes inspired by nature.

Made of resin and mineral filler, **KROMTEK** technology products feature a matte acrylic coating, high durability, antibacterial treatment, and easy cleaning.

Entdecken Sie neue Modelle und Konfigurationsmöglichkeiten und verleihen Sie Ihrem Badezimmer mit einer exklusiven Auswahl an von der Natur inspirierten Oberflächen Farbe.

Die Produkte mit **KROMTEK**-Technologie bestehen aus Harz und Mineralfüllstoffen und verfügen über eine matte Acrylbeschichtung, hohe Haltbarkeit, antibakterielle Behandlung und einfache Reinigung.

Scopri nuovi modelli e opzioni di configurazione e dai colore al tuo bagno con un'esclusiva selezione di finiture ispirate alla natura.

Realizzati in resina e cariche minerali, i prodotti con tecnologia **KROMTEK** presentano un rivestimento acrilico opaco, elevata durabilità, trattamento antibatterico e facile pulizia.





**KROMTEK** is the coating technology developed by **Coycama** for our resin washbasins and ceramic washbasins. Originating from cutting-edge industries like the automotive sector, this technology has been expertly adapted by specialist technicians and has successfully passed all tests conducted by the **AIDIMME** Institute of Technology.

**KROMTEK** ist die von **Coycama** entwickelte Beschichtungstechnologie für unsere Harz- und Keramikwaschbecken. Diese Technologie stammt aus fortschrittlichen Branchen wie der Automobilindustrie und wurde von Spezialisten angepasst. Sie hat erfolgreich alle Tests des technologischen Instituts **AIDIMME** bestanden.

**KROMTEK** è la tecnologia di rivestimento sviluppata da **Coycama** per i nostri lavabi in resina e ceramica. Questa tecnologia proviene da settori avanzati come l'industria automobilistica ed è stata adattata da tecnici specializzati, superando con successo tutti i test condotti dall'istituto tecnologico **AIDIMME**.



RESISTANT TO  
ABRASION



RESISTANT TO  
SCRATCHES



RESISTANT TO  
TEMPERATURE CHANGES



HYGIENIC AND EASY  
TO CLEAN



RESISTANT TO  
CHEMICALS AND STAINS



HIGH  
DURABILITY

Technology certified by an independent laboratory.



“**Colour** is a power that directly influences the soul.”

– Wassily Kandinsky

Mara washbasin, f46, 2 sinks, 121 (60+60) cm, Matte Island.



WASHBASIN / WASCHBECKEN / LAVABO  
**MARA**

Mara Washbasin, f46, 1 sink, 101 (30+70), Matte Leaf.



PLINTHED WASHBASIN / WASCHBECKEN / LAVABO  
**MARA**

Mara plinthed washbasin 10 cm, F46, 1 sink with towel rail. **80 cm**, Metallized Gold.



Mara plinthed washbasin 10 cm, f46, 2 sinks with towel rail. **140 (70+70) cm**, Matte Anthracite.





Mara plinthed washbasin 12 cm, f46, 3 sinks "M" (custom-made). 200 cm, Matte Mink.

CUSTOM-MADE / MASSGESCHNEIDERT / SU MISURA  
**MARA**

Mara plinthed washbasin 12 cm, f40, 2 sinks "XS" with overflow (custom-made). 160 cm, Matte Leaf.



WALL MOUNTED WASHBASIN /  
 WASCHTISCHPLATTEBECKEN / LAVABO A MURO  
**MARA**

Wall-Mounted washbasin Mara, 1 sink. 101 cm, Matte Island.



Plinthead Wall-Mounted washbasin, 1 sink. 100 cm, Matte Soil.

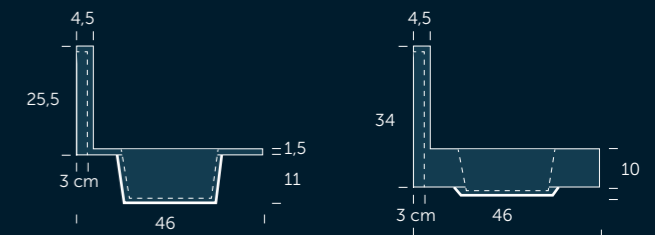

COUNTERTOPS / ABDECKUNG / PIANO  
PLINTHED COUNTERTOPS / WASCHTISCHPLATTE / PIANO CON GONNA  
**MARA**

Plinthed Mara countertop 10 cm, f46 cm, **140 cm**, Matte Anthracite.  
Orbit Countertop basin, Matte Sunset.



Mara countertop, Slate texture, f46 cm, **141 cm**, Matte Garden.  
Orbit Countertop basin, Matte Garden.



Darya washbasin, 1 sink. 100 cm, Matte Flower.

WASHBASIN / WASCHBECKEN / LAVABO |  
**DARYA**



Darya washbasin, 60 cm, Matte Blue Space.





Iris plinthed washbasin 10 cm, f46, 2 sinks (custom-made), 120 cm, Matte Beige.

WASHBASIN / WASCHBECKEN / LAVABO  
**IRIS**

Iris washbasin, f46, 1 sink. 101 cm, Matte Leaf.

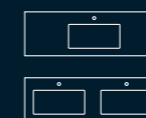

CUSTOM-MADE / NACH MAß / SU MISURA  
**IRIS**

Iris washbasin, f46, 1 sink (custom-made), 121 cm, Matte Sunset.

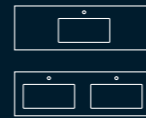



Iris pinthed washbasin, 12 cm, f50, 2 sinks (custom-made), 180 cm, Matte Mist.



## COUNTERTOP / ABDECKUNG / PIANO MYTHO

Countertops made of resin and mineral filler with coating.  
Abdeckung aus Harz und Mineralfüllstoff mit Beschichtung.  
Piani di lavoro in resina e filler minerale con rivestimento.



-  Carrara
-  Marquina Storm
-  Pure Cement

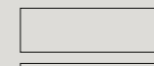

COUNTERTOP BASIN / AUFSATZWASCHBECKEN / LAVABO DA APPOGGIO  
**RESIN COLOR / RESIN DECO**

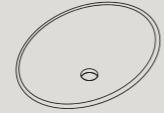

**ORBIT**  
57 x 41 x 11

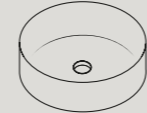

15 finishes / Oberflächen / finiture



**ARUBA**  
Ø37 x 11

15 finishes / Oberflächen / finiture



-  Carrara
-  Marquina Storm
-  Pure Cement

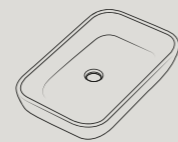

**MASAI /  
MASAI DUO**  
51 x 33 x 11

15 finishes / Oberflächen / finiture



15 finishes / White



**BARBADOS**  
37 x 37 x 12

15 finishes / Oberflächen / finiture



-  Carrara
-  Marquina Storm
-  Pure Cement

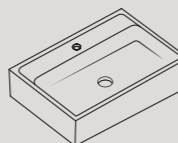

**SAONA**  
51 x 35 x 10

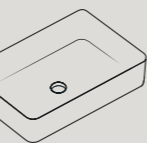

15 finishes / Oberflächen / finiture



**CURAZAO**  
51 x 34 x 11

15 finishes / Oberflächen / finiture



-  Carrara
-  Marquina Storm
-  Pure Cement

# MARA DEPTH 46 cm.

# COLOUR RESIN

It comes with tap drilling. Option without drilling, faucet available on request. Add (G) to the reference.  
Es wird mit Bohrung für den Wasserhahn geliefert. Option ohne Bohrung, Wasserhahn auf Anfrage. Fügen Sie (G) zur Referenz hinzu.  
Viene fornito con foratura per il rubinetto. Opzione senza foratura, rubinetto su richiesta. Aggiungere (G) alla referenza.

● BLACK IN STOCK  
● WHITE AND BLACK IN STOCK (rest available upon request).

It comes undrilled. Es wird unvorbereitet geliefert. Viene non forato.

It comes undrilled. Es wird unvorbereitet geliefert. Viene non forato.

## WASHBASIN

Height: 15 cm



### 1 SINK CENTRED

cm	Reference
61	540 XX 060
71	540 XX 070
81	540 XX 080
101	540 XX 100
121	540 XX 120



### 1 SINK LEFT

cm	Reference
81 (60+20)	540 XX 081
91 (70+20)	540 XX 092
101 (70+30)	540 XX 101
111 (80+30)	540 XX 111
121 (60+60)	540 XX 121
141 (70+70)	540 XX 141



### 1 SINK RIGHT

cm	Reference
81 (20+60)	540 XX 083
91 (20+70)	540 XX 094
101 (30+70)	540 XX 103
111 (30+80)	540 XX 113
121 (60+60)	540 XX 123
141 (70+70)	540 XX 143



### 2 SINKS

cm	Reference
121 (60+60)	540 XX 122
141 (70+70)	540 XX 142
161 (80+80)	540 XX 162

CUSTOM-MADE

### MOVABLE SINKS

<b>1 SINK</b>	632 XX 001
cm	from 61 to 201
<b>2 SINKS</b>	632 XX 002
cm	from 121 to 201



For custom-made washbasins, it is essential to provide a plan detailing the drain positions. A minimum margin of 6.5 cm must be maintained between the side and the sink or between the sinks of the washbasin.

Für maßgefertigte Waschtische ist es erforderlich, einen Plan mit den Positionen der Abflüsse bereitzustellen. Ein Mindestabstand von 6,5 cm muss zwischen der Seite und dem Waschbecken oder zwischen den Becken des Waschtisches eingehalten werden.

Per i lavabi su misura, è essenziale fornire un piano che dettagli le posizioni dei drenaggi. Deve essere mantenuto un margine minimo di 6,5 cm tra il lato e il lavabo o tra i lavabi del lavabo.



Minimum margin: 6.5 cm  
Mindestabstand: 6,5 cm  
Margine minimo: 6,5 cm

### SINK MEASUREMENT

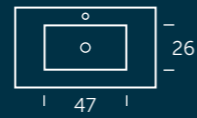

Sink depth: 10 cm  
Tiefen des Waschbeckens: 10 cm  
Profondità del lavabo: 10 cm

## COUNTERTOP

Height: 12 cm  
Reinforcement Bar required



cm	Reference
61	542 XX 060
71	542 XX 070
81	542 XX 080
101	542 XX 100
121	542 XX 120
141	542 XX 140
161	542 XX 160
181	542 XX 180
201	542 XX 200

CUSTOM-MADE

### OPTION TEXTURE

Upon request  
Add the reference: (P) Slate

Ref	642 XX 000
cm	to 201

## WALL-MOUNTED

Height: 25,5 cm



### 1 SINK | 2 SINKS

cm	Reference
61	544 XX 060
71	544 XX 070
81	544 XX 080
101	544 XX 100
121 1s centred	544 XX 120
121 2s (60+60)	544 XX 122
141 1s centred	544 XX 140
141 2s (70+70)	544 XX 142



Wall-Mounted connection kit  
/ Wandmontage-Anschlusskit  
/ Kit di collegamento da parete  
60 cm hoses + connection elbows.  
60 cm Schläuche + Verbindungsecken.  
Tubi da 60 cm + gomiti di connessione.

Reference
412 00 060



## DRILLING SERVICE

Plan required  
Ref: 435 00 050

Countertops, plinthed countertops and wall-mounted washbasins are supplied without drilling. Easily drillable with a woodworker's crown drill bit. Abdeckung, plinthe Abdeckung und wandmontierte Waschbecken werden ohne Bohrungen geliefert. Einfach mit einem Holzbohrerkrone-Bohrer zu bohren. Piano, piano con gonnella e lavabi a parete sono forniti senza fori. Facile da forare con una punta a corona da falegname.

## INTEGRATED TOWEL RAIL

Extension 10 cm with cut. / Erweiterung 10 cm mit Schnitt. / Estensione 10 cm con taglio.



## REINFORCEMENT BAR FOR COUNTERTOP

To avoid deformation of the countertops, it is necessary to install the reinforcement bar in the module where the washbasin will be supported. Um Verformungen der Abdeckung zu vermeiden, ist es notwendig, die Verstärkungsstange im Modul zu installieren, in dem das Waschbecken unterstützt wird. Per evitare deformazioni del top, è necessario installare la barra di rinforzo nel modulo in cui sarà supportato il lavabo.

cm	Reference
60	425 14 060
70	425 14 070
80	425 14 080
90	425 14 090
100	425 14 100
120	425 14 120

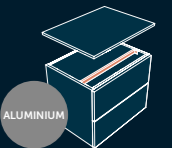

## PLINTHED WASHBASIN

Plinth height: 10 cm | For plinths from 11 to 20 cm, see page 383



### 1 SINK CENTRED

cm	Reference
60	541 XX 060
70	541 XX 070
80	541 XX 080
100	541 XX 100
120	541 XX 120



### 1 SINK LEFT

cm	Reference
80 (60+20)	541 XX 081
90 (70+20)	541 XX 092
100 (70+30)	541 XX 101
110 (80+30)	541 XX 111
120 (60+60)	541 XX 121
140 (70+70)	541 XX 141



### 1 SINK RIGHT

cm	Reference
80 (20+60)	541 XX 083
90 (20+70)	541 XX 094
100 (30+70)	541 XX 103
110 (30+80)	541 XX 113
120 (60+60)	541 XX 123
140 (70+70)	541 XX 143



### 2 SINKS

cm	Reference
120 (60+60)	541 XX 122
140 (70+70)	541 XX 142
160 (80+80)	541 XX 162

CUSTOM-MADE

### MOVABLE SINKS

<b>1 SINK</b>	633 XX 001
cm	from 60 to 200
<b>2 SINKS</b>	633 XX 002
cm	from 120 to 200



For custom-made washbasins, it is essential to provide a plan detailing the drain positions. A minimum margin of 6.5 cm must be maintained between the side and the sink or between the sinks of the washbasin.

Für maßgefertigte Waschtische ist es erforderlich, einen Plan mit den Positionen der Abflüsse bereitzustellen. Ein Mindestabstand von 6,5 cm muss zwischen der Seite und dem Waschbecken oder zwischen den Becken des Waschtisches eingehalten werden.

Per i lavabi su misura, è essenziale fornire un piano che dettagli le posizioni dei drenaggi. Deve essere mantenuto un margine minimo di 6,5 cm tra il lato e il lavabo o tra i lavabi del lavabo.



Minimum margin: 6.5 cm  
Mindestabstand: 6,5 cm  
Margine minimo: 6,5 cm

### SINK MEASUREMENT

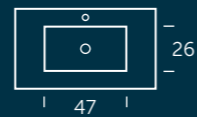

Sink depth: 10 cm  
Tiefen des Waschbeckens: 10 cm  
Profondità del lavabo: 10 cm

## PLINTHED COUNTERTOP

Plinth height: 10 cm  
For plinths from 11 to 20 cm, see page 383



cm	Reference
60	543 XX 060
70	543 XX 070
80	543 XX 080
100	543 XX 100
120	543 XX 120
140	543 XX 140
160	543 XX 160
180	543 XX 180
200	543 XX 200

CUSTOM-MADE

Plinth	10 cm
Ref	643 XX 000
cm	from 50 to 200

## PLINTHED WALL-MOUNTED

Total height: 34 cm - Plinth height: 10 cm



### 1 SINK | 2 SINKS

cm	Reference
60	545 XX 060
70	545 XX 070
80	545 XX 080
100	545 XX 100
120 1s centred	545 XX 120
120 2s (60+60)	545 XX 122
140 1s centred	545 XX 140
140 2s (70+70)	545 XX 142



Wall-Mounted connection kit  
/ Wandmontage-Anschlusskit  
/ Kit di collegamento da parete  
60 cm hoses + connection elbows.  
60 cm Schläuche + Verbindungsecken.  
Tubi da 60 cm + gomiti di connessione.

Reference
412 00 060

## TOWEL RAIL PLINTH

Centred placement in the sink. Provide a plan if a different position is desired. Not available for the ZEN model. Zentrierte Platzierung im Waschbecken. Ein Plan muss bereitgestellt werden, wenn eine andere Position gewünscht wird. Nicht verfügbar für das ZEN-Modell. Posizionamento centrato nel lavabo. Fornire un piano se si desidera una posizione diversa. Non disponibile per il modello ZEN.



Reference	416 01 002
Double towel rail	416 01 003

## INVISIBLE BRACKETS

Support systems with leveling adjustments and screws included for wall-mounted basins, countertops, and plinthed countertops. Two sets are included for sizes equal to or greater than 140 cm. Unterstützungssysteme mit Höhenverstellung und Schrauben für wandhängende Waschbecken, Waschtische und plinthe Waschtische. Zwei Sets sind bei Größen von 140 cm oder mehr enthalten.

Sistemi di supporto con regolazioni di livello e viti inclusi per lavabi sospesi, piani lavabo e lavabi plintati. Due set sono inclusi per dimensioni pari o superiori a 140 cm.

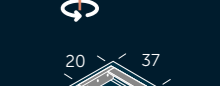
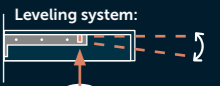

For overflow, ornament, and more customization options. Für Überlauf, Ornament und weitere Anpassungsoptionen. Per sovrapposizione, ornamento e altre opzioni di personalizzazione. see page 383.

## 15 FINISHES / OBERFLÄCHEN / FINITURE

Replace XX with the chosen colour code  
Ersetzen Sie XX durch den gewählten Farbcode  
Sostituire XX con il codice colore scelto

White 06	Mist 22	Anthraxite 03	Black 02	Beige 05	Mink 19	Soil 20
----------	---------	---------------	----------	----------	---------	---------

Sunset 08	Flower 26	Leaf 25	Garden 73	Island 23	Blue Space 10	Met. Gold 16	Met. Lead 17
-----------	-----------	---------	-----------	-----------	---------------	--------------	--------------

RAL COLOURS  
Upon request  
Auf Anfrage  
Su richiesta

# MARA | CUSTOM-MADE

## DEPTHS from 40 to 60 cm.

COLOUR RESIN

### AMBAR SINKS

#### SINKS MEASUREMENTS

**XS**

Sink depth: 8.5 cm  
Waschbecken-Tiefe: 8.5 cm  
Profondità del lavabo: 8.5 cm

**Washbasin depth: from 40 to 45 cm**  
Optional for depths up to 60 cm.  
Optional für Tiefen bis zu 60 cm.  
Opzionale per profondità fino a 60 cm.

**M**

Sink depth: 10 cm  
Waschbecken-Tiefe: 10 cm  
Profondità del lavabo: 10 cm

**Washbasin depth: from 46 to 49 cm**  
Optional for depths from 50 to 60 cm.  
Optional für Tiefen von 50 bis 60 cm.  
Opzionale per profondità da 50 a 60 cm.

**XL**

Sink depth: 10 cm  
Waschbecken-Tiefe: 10 cm  
Profondità del lavabo: 10 cm

**Washbasin depth: from 50 to 60 cm**  
Waschbecken-Tiefe: von 50 bis 60 cm  
Profondità del lavabo: da 50 a 60 cm

Minimum margin: 6.5 cm  
Mindestabstand: 6.5 cm  
Margine minimo: 6.5 cm

For custom-made washbasins, plinthed washbasins it is essential to provide a plan detailing the drain positions. A minimum margin of 6.5 cm must be maintained between the side and the sink or between the sinks of the washbasin.

Für maßgefertigte Waschbecken und Waschbecken mit plinthe ist es unerlässlich, einen Plan mit den Positionen der Abflüsse bereitzustellen. Ein Mindestabstand von 6,5 cm muss zwischen der Seite und dem Waschbecken oder zwischen den Waschbecken des Möbels eingehalten werden.

Per lavabi su misura e lavabi con gonna, è essenziale fornire un piano che dettagli le posizioni dei drenaggi. Deve essere mantenuto un margine minimo di 6,5 cm tra il lato e il lavabo o tra i lavabi del mobile.

### WASHBASIN

It comes with tap drilling. Option without drilling, faucet available on request. Add (G) to the reference.  
Es wird mit Bohrung für den Wasserhahn geliefert. Option ohne Bohrung, Wasserhahn auf Anfrage. Fügen Sie (G) zur Referenz hinzu. Viene fornito con foratura per il rubinetto. Opzione senza foratura, rubinetto su richiesta. Aggiungere (G) alla referenza.

Height: 1.5 cm

#### 1 SINK MOVABLE

60 to 201 cm

Depth	40 cm	to 50 cm	to 60 cm
ref	630 XX 001	634 XX 001	636 XX 001

\*Measure 60: Available only for depths up to 49 cm.  
\*\*Measure 60 to 71: For depths from 50 cm, the minimum width is 65 cm.

\*Maß 60: Nur für Tiefen bis 49 cm verfügbar.  
\*\*Maß 60 bis 71: Für Tiefen ab 50 cm beträgt die Mindestbreite 65 cm.

#### 2 SINKS MOVABLE

121 to 201 cm

Depth	40 cm	to 50 cm	to 60 cm
ref	630 XX 002	634 XX 002	636 XX 002

\*Misura 60: Disponibile solo per profondità fino a 49 cm.  
\*\*Misura 60 a 71: Per profondità superiori a 50 cm, la larghezza minima è di 65 cm.

#### 1 SINK (XS) 51 X 41 CM

measurement 630 XX 051 51x41

### PLINTHED WASHBASINS

Plinth height: 10 cm | For plinths from 11 to 20 cm, see page 383

#### 1 SINK MOVABLE

60 to 200 cm

Depth	40 cm	to 50 cm	to 60 cm
ref	631 XX 001	635 XX 001	637 XX 001

\*Measure 60: Available only for depths up to 49 cm.  
\*\*Measure 60 to 70: For depths from 50 cm, the minimum width is 65 cm.

\*Maß 60: Nur für Tiefen bis 49 cm verfügbar.  
\*\*Maß 60 bis 70: Für Tiefen ab 50 cm beträgt die Mindestbreite 65 cm.

#### 2 SINKS MOVABLE

120 to 200 cm

Depth	40 cm	to 50 cm	to 60 cm
ref	631 XX 002	635 XX 002	637 XX 002

\*Misura 60: Disponibile solo per profondità fino a 49 cm.  
\*\*Misura 60 a 70: Per profondità superiori a 50 cm, la larghezza minima è di 65 cm.

### COUNTERTOP

It comes undrilled. Es wird unvorbereitet geliefert. Viene non forato.

Height: 1.2 cm

Reinforcement Bar required / Verstärkungsstab erforderlich / Barra di rinforzo necessaria

51 to 201 cm

Depth	40 cm	to 50 cm	to 60 cm
ref	640 XX 000	644 XX 000	646 XX 000

\*Measure 51: Depth 41 cm  
\*Maß 51: Tiefe 41 cm  
\*Misura 51: Profondità 41 cm

**SLATE TEXTURE OPTION** On request  
Add to the reference: (P)

### PLINTHED COUNTERTOP

It comes undrilled. Es wird unvorbereitet geliefert. Viene non forato.

Plinth height: 10 cm | For plinths from 11 to 20 cm, see page 383

50 to 200 cm

Depth	40 cm	to 50 cm	to 60 cm
ref	641 XX 000	645 XX 000	647 XX 000

\*Measure 50: Depth 41 cm  
\*Maß 50: Tiefe 41 cm  
\*Misura 50: Profondità 41 cm

### DRILLING SERVICE

Plan required  
Ref: 435 00 050

Countertops, plinthed countertops and wall-mounted washbasins are supplied without drilling. Easily drillable with a woodworker's crown drill bit. Abdeckung, plinthe Abdeckung und wandmontierte Waschbecken werden ohne Bohrungen geliefert. Einfach mit einem Holzbohrerkrone-Bohrer zu bohren. Piano, piano con gonna e lavabi a parete sono forniti senza fori. Facile da forare con una punta a corona da falegname.

### INTEGRATED TOWEL RAIL

Extension 10 cm with cut. / Erweiterung 10 cm mit Schnitt. / Estensione 10 cm con taglio.

### REINFORCEMENT BAR FOR COUNTERTOP

To avoid deformation of the countertops, it is necessary to install the reinforcement bar in the module where the washbasin will be supported. Um Verformungen der Abdeckung zu vermeiden, ist es notwendig, die Verstärkungsstange im Modul zu installieren, in dem das Waschbecken unterstützt wird. Per evitare deformazioni del top, è necessario installare la barra di rinforzo nel modulo in cui sarà supportato il lavabo.

cm	Reference
60	425 14 060
70	425 14 070
80	425 14 080
90	425 14 090
100	425 14 100
120	425 14 120

ALUMINIUM

### TOWEL RAIL PLINTH

Centred placement in the sink. Provide a plan if a different position is desired. Not available for the ZEN model. Zentrierte Platzierung im Waschbecken. Ein Plan muss bereitgestellt werden, wenn eine andere Position gewünscht wird. Nicht verfügbar für das ZEN-Modell. Posizionamento centrato nel lavabo. Fornire un piano se si desidera una posizione diversa. Non disponibile per il modello ZEN.

Reference	Double towel rail
416 01 002	416 01 003

### INVISIBLE BRACKETS

Support systems with leveling adjustments and screws included for wall-mounted basins, countertops, and plinthed countertops. Two sets are included for sizes equal to or greater than 140 cm. Unterstützungssysteme mit Höhenverstellung und Schrauben für wandhängende Waschbecken, Waschtische und plinthed Waschtische. Zwei Sets sind bei Größen von 140 cm oder mehr enthalten. Sistemi di supporto con regolazioni di livello e viti inclusi per lavabi sospesi, piani lavabo e lavabi plintati. Due set sono inclusi per dimensioni pari o superiori a 140 cm.

For overflow, ornament, and more customization options. Für Überlauf, Ornament und weitere Anpassungsoptionen. Per sovrappressione, ornamento e altre opzioni di personalizzazione. see page 383.

## 15 FINISHES / OBERFLÄCHEN / FINITURE

- White 06
- Mist 22
- Anthracite 03
- Black 02
- Beige 05
- Mink 19
- Soil 20

- Sunset 08
- Flower 26
- Leaf 25
- Garden 73
- Island 23
- Blue Space 10
- Met. Gold 16
- Met. Lead 17

RAL COLOURS  
Upon request  
Auf Anfrage  
Su richiesta

# IRIS

DEPTH **46** cm.

• **BLACK IN STOCK**  
(rest available upon request).



## WASHBASIN

Height: 1.5 cm



### 1 SINK CENTRED

cm	Reference
61	536 XX 060
81	536 XX 080
101	536 XX 100
121	536 XX 120

### 2 SINKS

cm	Reference
121 (60+60)	536 XX 122

### 1 SINK MOVABLE

1 SINK	cm	Reference
	650 XX 001	from 61 to 201

### 2 SINK MOVABLE

2 SINKS	cm	Reference
	650 XX 002	from 121 to 201

Overflow option not available.  
/ Überlaufoption nicht verfügbar.  
/ Opzione di troppopieno non disponibile.

# IRIS CUSTOM - MADE

DEPTHS from **47** to **60** cm.



## WASHBASIN

Height: 1.5 cm

### 1 SINK MOVABLE



Depth	47 - 50 cm	to 60 cm
ref	652 XX 001	654 XX 001

### 2 SINKS MOVABLE



Depth	47 - 50 cm	to 60 cm
ref	652 XX 002	654 XX 002

Overflow option not available.  
/ Überlaufoption nicht verfügbar.  
/ Opzione di troppopieno non disponibile.

CUSTOM-MADE

## PLINTHED WASHBASINS

Plinth height: 10 cm | For plinths from 11 to 20 cm, see page 383



### 1 SINK CENTRED

cm	Reference
60	537 XX 060
80	537 XX 080
100	537 XX 100
120	537 XX 120

### 2 SINKS

cm	Reference
120 (60+60)	537 XX 122

### 1 SINK MOVABLE

1 SINK	cm	Reference
	651 XX 001	from 60 to 200

### 2 SINKS MOVABLE

2 SINKS	cm	Reference
	651 XX 002	from 120 to 200

Towel rail or overflow option not available.  
/ Option Handtuchstange oder Überlauf nicht verfügbar.  
/ Opzione porta asciugamani o troppopieno non disponibile.



## PLINTHED WASHBASINS

Plinth height: 10 cm | For plinths from 11 to 20 cm, see page 383

### 1 SINK MOVABLE



Depth	47 - 50 cm	to 60 cm
ref	653 XX 001	655 XX 001

### 2 SINKS MOVABLE



Depth	47 - 50 cm	to 60 cm
ref	653 XX 002	655 XX 002

Towel rail or overflow option not available.  
/ Option Handtuchstange oder Überlauf nicht verfügbar.  
/ Opzione porta asciugamani o troppopieno non disponibile.

CUSTOM-MADE

## IRIS SINK

### SINK MEASUREMENT

Depth: 9 cm / Tiefe: 9 cm / Profondità: 9 cm

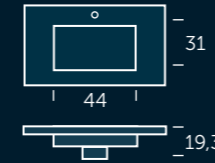

Minimum margin: 8 cm  
Mindestabstand: 8 cm  
Margine minimo: 8 cm



For custom-made washbasins, plinthed washbasins it is essential to provide a plan detailing the drain positions. A minimum margin of 8 cm must be maintained between the side and the sink or between the sinks of the washbasin.

Für maßgefertigte Waschbecken und Waschbecken mit Plinthe ist es unerlässlich, einen Plan mit den Positionen der Abflüsse bereitzustellen. Ein Mindestabstand von 8 cm muss zwischen der Seite und dem Waschbecken oder zwischen den Waschbecken des Möbels eingehalten werden.

Per lavabi su misura e lavabi con gonna, è essenziale fornire un piano che dettagli le posizioni dei drenaggi. Deve essere mantenuto un margine minimo di 8 cm tra il lato e il lavabo o tra i lavabi del mobile.

### INVISIBLE BRACKETS

Support systems with leveling adjustments and screws included for wall-mounted basins. Two sets are included for sizes equal to or greater than 140 cm.

Unterstützungssysteme mit Höhenverstellung und Schrauben für wandhängende Waschbecken. Zwei Sets sind bei Größen von 140 cm oder mehr enthalten.

Sistemi di supporto con regolazioni di livello e viti inclusi per lavabi sospesi. Due set sono inclusi per dimensioni pari o superiori a 140 cm.

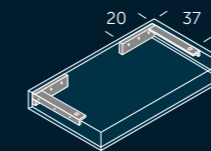

### Leveling system:



For ornament, and more customization options. Für Ornament und weitere Anpassungsoptionen. Per ornamento e altre opzioni di personalizzazione. see page 383.

# DARYA

# COLOUR RESIN

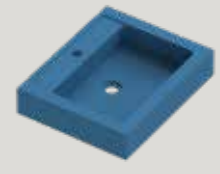

Depth: 46 cm | Height: 10 cm

### Wall-Mounted

cm	Reference
60	548 XX 060
80	548 XX 080
100 1 Tap	548 XX 100
100 2 Taps	548 XX 102
120 1 Tap	548 XX 120
120 2 Taps	548 XX 122

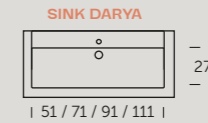

Depth: 41 cm | Height: 10 cm

### Wall-Mounted or Countertop basin

cm	Reference
50	548 XX 050

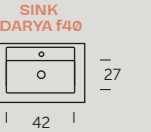

They are supplied with a tap hole. Option without drilling, add (G) to the reference. Overflow option available. Sie werden mit einem Hahnloch geliefert. Option ohne Bohrung: Fügen Sie (G) zur Referenz hinzu. Überlaufoption verfügbar. Sono forniti con foro per il rubinetto. Opzione senza foratura: aggiungere (G) alla referenza. Opzione con troppo pieno disponibile.

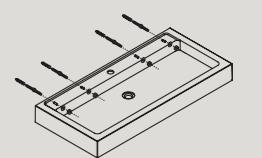

INSTALLATION SYSTEM INCLUDED.

## COUNTERTOP BASINS

• **BLACK, MINK, BLUE SPACE, LEAF and MIST, IN STOCK** (rest available upon request).



### ORBIT

cm	Reference
57x41x11	518 XX 057



### ARUBA

cm	Reference
ø37x11	581 XX 037



### MASAI

cm	Reference
51x33x11	518 XX 051



### CURAZAO

cm	Reference
51x34x11	585 XX 034

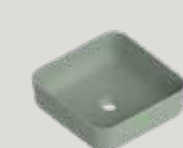

### BARBADOS

cm	Reference
37x37x12	583 XX 037



### MASAI DUO

cm	Reference
51x33x11	523 XX 051

White interior / Colour exterior.

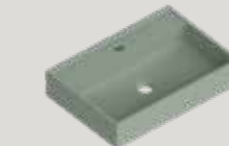

### SAONA

cm	Reference
51x35x10	586 XX 049

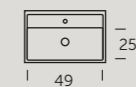

### 15 FINISHES / 15 OBERFLÄCHEN / 15 FINITURE

White 06	Mist 22	Anthracite 03	Black 02	Beige 05
Mink 19	Soil 20	Sunset 08	Flower 26	Leaf 25
Garden 73	Island 23	Blue Space 10	Met. Or 16	Met. Lead 17



RAL COLOURS  
Upon request  
Auf Anfrage  
Su richiesta

Replace the XX with the chosen colour code. Ersetzen Sie das XX durch den gewählten Farbcode. Sostituire XX con il codice colore scelto.

It comes with tap drilling. Option without drilling, faucet available on request. Add (G) to the reference. Es wird mit Bohrung für den Wasserhahn geliefert. Option ohne Bohrung, Wasserhahn auf Anfrage. Fügen Sie (G) zur Referenz hinzu. Viene fornito con foratura per il rubinetto. Opzione senza foratura, rubinetto su richiesta. Aggiungere (G) alla referenza.

## DECO RESIN

### COUNTERTOP MYTHO

Depth: 46 cm | Height: 1.2 cm

• **IN STOCK** (rest available upon request).



#### CARRARA

cm Reference

- 61 532 76 060
- 81 532 76 080
- 101 532 76 100
- 121 532 76 120
- 141 532 76 140

cm/lin 532 76 999

Made-to-measure manufacturing upon request up to 200 cm.

Maßanfertigung auf Anfrage bis zu 200 cm.

Produzione su misura su richiesta fino a 200 cm.

#### MARQUINA STORM

cm Reference

- 61 532 77 060
- 81 532 77 080
- 101 532 77 100
- 121 532 77 120
- 141 532 77 140

cm/lin 532 77 999

Made-to-measure manufacturing upon request up to 200 cm.

Maßanfertigung auf Anfrage bis zu 200 cm.

Produzione su misura su richiesta fino a 200 cm.

#### PURE CEMENT

cm Reference

- 61 532 95 060
- 81 532 95 080
- 101 532 95 100
- 121 532 95 120
- 141 532 95 140

cm/lin 532 95 999

Made-to-measure manufacturing upon request up to 200 cm.

Maßanfertigung auf Anfrage bis zu 200 cm.

Produzione su misura su richiesta fino a 200 cm.

### 3 FINISHES / 3 OBERFLÄCHEN / 3 FINITURE

Carrara 76

Marquina Storm 77

Pure Cement 95



#### DRILLING SERVICE

Plan required. Ref: 435 00 050

The countertops are supplied undrilled. They can be easily drilled with a wood carpenter's hole saw.

Die Abdeckung werden ungebort geliefert. Sie können leicht mit einer Holz-Kreissäge gebohrt werden.

I piani sono forniti senza fori. Possono essere facilmente forati con una sega a tazza per legno.

### COUNTERTOP BASINS



#### BARBADOS

37x37x12cm

cm Referencia

- Carrara 583 76 037
- Marquina Storm 583 77 037
- Pure Cement 583 95 037

#### ARUBA

ø37x11 cm

cm Referencia

- Carrara 581 76 037
- Marquina Storm 581 77 037
- Pure Cement 581 95 037

#### CURAZAO

51x34x11cm

cm Referencia

- Carrara 585 76 034
- Marquina Storm 585 77 034
- Pure Cement 585 95 034

### CUSTOM MANUFACTURING / MASSGESCHNEIDERTE FERTIGUNG / PRODUZIONE SU MISURA PLAN INDICATIONS / PLANANGABEN / INDICAZIONI DEL PIANO

For custom-made washbasins, plinthed washbasins, taps, and plinth countertops, it is essential to attach a plan detailing the following minimum information.  
Für maßgefertigte Waschtische, Waschtische mit Sockel, Waschtische und Waschtische mit Sockel muss ein Plan beigefügt werden, der die folgenden Mindestinformationen enthält.  
Per lavabi, lavabi con gonna, rubinetti e top con plinto su misura, è indispensabile allegare un piano che dettagli le seguenti informazioni minime.

- 1 Total width, depth, and height of the desired plinth.  
Gesamte Breite, Tiefe und Höhe des gewünschten Sockels.  
Larghezza totale, profondità e altezza del plinto desiderato.
- 2 Distance between the side and the center of the washbasins.  
Abstand zwischen der Seite und dem Mittelpunkt der Waschtische.  
Distanza tra il lato e il centro dei lavabi.
- 3 Position of the drain and the tap in the case of countertops and plinth countertops.  
Position des Abflusses und des Wasserhahns im Fall von Waschtischen und Waschtischen mit Sockel.  
Posizione dello scarico e del rubinetto nel caso di top e top con gonna.
- 4 Special cuts.  
Sonderanfertigungen.  
Tagli speciali.
- 5 Indicate the location of the towel rail.  
Standort des Handtuchhalters angeben.  
Indicare la posizione del portasciugamani.

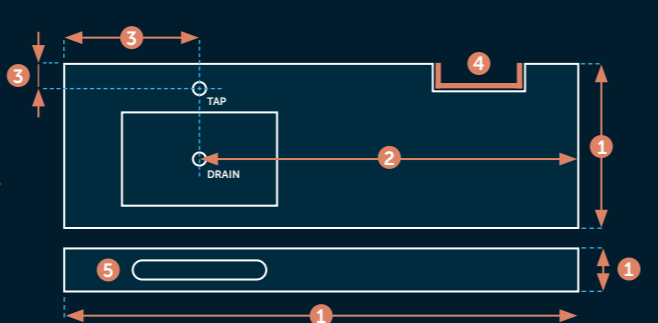

## COLOUR RESIN / SOLID SURFACE CUSTOM OPTIONS

Add a plinthed towel rail, overflow, ornament, or the absence of tap drilling. Also, include custom cuts, angled or off-square, and adapt the washbasin or plinthed countertop to your space.

Fügen Sie einen überstehenden Handtuchhalter, einen Überlauf, ein Ornament oder das Fehlen eines Wasserhahnlöchers hinzu. Ebenso können individuelle Zuschnitte, Winkel- oder schräg zugeschnittene Varianten sowie die Anpassung des Waschtischs oder des plinthed Waschtischs an Ihren Raum berücksichtigt werden.

Aggiungi un portarotolo rialzato, un troppopieno, un ornamento, o l'assenza di foro per rubinetto. Includi anche tagli su misura, angoli o tagli obliqui, e adatta il lavabo o il piano vasque su misura al tuo spazio.

### OPTION EXTRA SINK

You can add an extra sink to your washbasins. (Remember to consider the minimum margins). Sie können Ihrem Waschbecken ein zusätzliches Becken hinzufügen. (Denken Sie daran, die Mindestabstände zu berücksichtigen). Puoi aggiungere una vasca extra ai tuoi lavabi. (Ricordati di considerare i margini minimi).

### EXTRA MEASUREMENT

Inquire about washbasins, countertops, and plinthed countertops up to 250 cm. Erkundigen Sie sich nach Waschbecken, Arbeitsplatten und erhöhten Arbeitsplatten bis zu 250 cm. Informati su lavabi, piani d'appoggio e piani d'appoggio sopraelevati fino a 250 cm.

### OPTION ORNAMENT

Reinforce the sealing between the washbasin and the wall with the installation of the ornament. Verstärken Sie die Abdichtung zwischen dem Waschtisch und der Wand durch die Installation des Zierelements. Rinforzare la sigillatura tra il lavabo e la parete con l'installazione dell'ornamento.

	46 to 200 cm		
Height	10 cm	to 20 cm	to 39 cm
SOLID SURFACE	618 01 010	618 01 020	618 01 039
COLOUR RESIN	648 XX 010	648 XX 020	648 XX 039

### SPECIAL CUTS

For cuts that are out of square, angled, etc., it is necessary to provide a plan. Für nicht rechtwinklige, schräge usw. Schnitte ist ein Plan erforderlich. Per tagli fuori squadra, angolati, ecc., è necessario fornire un piano.

### OPTION WITHOUT DRILLING TAP

For wall-mounted taps, you have the option to request the washbasin without drilling. Für wandmontierte Armaturen können Sie den Waschtisch ohne Bohrung anfordern. Per i rubinetti a parete, è possibile richiedere il lavabo senza fori.

Add a "G" at the end of the reference. Fügen Sie ein "G" am Ende der Referenz hinzu. Aggiungere una "G" alla fine del riferimento.

In stock, Ambar model sizes: 60, 70, 80, 100, 120 1s centred, and 120 2s.

Lagergrößen des Ambar-Modells: 60, 70, 80, 100, 120 1B zentriert und 120 2B.

Misure del modello Ambar disponibili in stock: 60, 70, 80, 100, 120 1V centrato e 120 2V.

### INCREMENT PLINTH HEIGHT

Increase the height of the plinth in plinthed washbasins and plinthed countertops from 11 to 20 cm. Erhöhen Sie die Höhe des Sockels bei erhöhten Waschtischen und erhöhten Arbeitsplatten von 11 auf 20 cm. Aumenta l'altezza del basamento nei lavabi con basamento e nei piani lavabo con basamento da 11 a 20 cm.

### OPTION PLINTHED TOWEL RAIL

You can incorporate one or two towel rails in the front plinth. The towel rail position will always be centred with the washbasin. With two washbasins and one towel rail, the location will be centred in the washbasin. For other placements, please send a plan. Not available for the Zen, Iris, Darya, and Zafiro models. Sie können ein oder zwei Handtuchhalter in den vorderen Sockel integrieren. Die Position des Handtuchhalters wird immer mittig zum Waschtisch ausgerichtet. Bei zwei Waschtischen und einem Handtuchhalter wird dieser mittig am Waschtisch platziert. Für andere Positionen senden Sie bitte eine Skizze. Nicht verfügbar für die Modelle Zen, Iris, Darya und Zafiro. È possibile integrare uno o due porta asciugamani nel basamento anteriore. La posizione del porta asciugamani sarà sempre centrata rispetto al lavabo. Con due lavabi e un solo porta asciugamani, questo sarà centrato sul lavabo. Per altre posizioni, si prega di inviare un disegno. Non disponibile per i modelli Zen, Iris, Darya e Zafiro.

Reference 416 01 002

Double towel rail 416 01 003

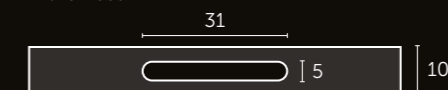

### OPTION OVERFLOW

Add an integrated resin overflow in the Ambar, Mara, Zafiro, and Darya models. Fügen Sie einen integrierten Harz-Überlauf in die Modelle Ambar, Mara, Zafiro und Darya ein. Aggiungere un troppopieno integrato in resina nei modelli Ambar, Mara, Zafiro e Darya.



# ÉPSILON

60 | 80 | 100 | 120

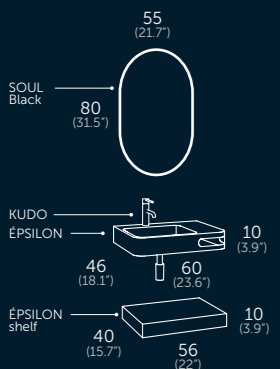

## ÉPSILON 60

- 594 16 060 E Épsilon 60 Metallic Gold / Metallisiert / Metallizzato  
with corner towel rail / Mit Eckhandtuchhalter  
/ con porta asciugamani angolare
- 410 02 101 Black Siphon / Siphon / Sifone
- 594 03 061 Épsilon Shelf 60 Anthracite / Regal / Scaffale
- 239 02 080 Soul Black
- 412 02 810 Kudo Black



Matte lacquered finish. Matt lackiert.  
Laccato opaco.

15 FINISHES



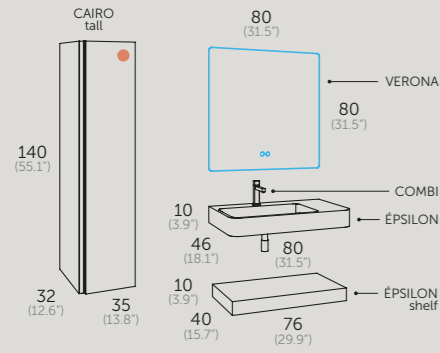

## ÉPSILON 80

- 594 73 080 L Épsilon 80 Garden  
with side towel rail / Mit seitlichem Handtuchhalter  
/ con porta asciugamani laterale
- 410 00 101 Chrome Siphon / Siphon / Sifone
- 594 73 081 Épsilon Shelf 80 Garden / Regal / Scaffale
- 246 00 080 Verona
- 194 37 335 Cairo Tall Grey Pine / Hoch / Alto
- 412 73 800 Combi Chrome - Garden



Soft close.  
Soft-close-System.  
Chiusura ammortizzata.



Matte lacquered finish.  
Matt lackiert.  
Laccato opaco.



Anti fog system.  
Anti-Beschlag-System.  
Sistema antiappannamento.



Ambient light.  
Umgebungslicht.  
Luce ambiente.



Intensity control.  
Intensitätsregler.  
Regolatore di intensità.



Dual sensor On/Off-anti fog.  
Doppelter Sensorschalter. On/Off.  
Doppio sensore touch. On/Off.  
Antiappannante.

15 FINISHES

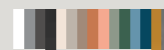



Matte lacquered finish.  
Matt lackiert.  
Laccato opaco.



Anti fog system.  
Anti-Beschlag-System.  
Sistema antiappannamento.



Ambient light.  
Umgebungslicht.  
Luce ambiente.



Dual sensor On/Off-anti fog.  
Doppelter Sensorschalter, On/Off.  
Doppio sensore touch, On/Off.  
Antiappannante.



Digital clock.  
Digitaluhr.  
Orologio digitale.



Bluetooth music player.  
2 speakers of 3W each.  
Musik Player integriert, Bluetooth  
Anschluss, 2 Lautsprecher je mit 3W.  
Lettore musicale integrato, connessione  
a Bluetooth, 2 altoparlanti 3W ciascuno.

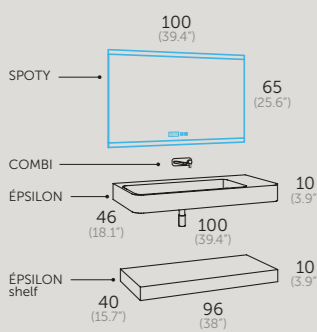

## ÉPSILON 100

- 594 23 100 G Épsilon 100 Island  
without drilled tap hole / ohne armaturenloch  
/ senza foro per rubinetto  
overflow option / Überlauf Optional  
/ opzione di troppopieno
- 410 00 101 Siphon Chrome / Siphon / Sifone  
594 23 101 Épsilon Shelf Island 100 / Regal / Scaffale  
267 00 100 Spoty  
412 00 808 Combi Wall-Mounted Chrome



Anti fog system.  
Anti-Beschlag-System.  
Sistema antiappannamento.



Ambient light.  
Umgebungslicht.  
Luce ambiente.



Intensity control.  
Intensitätsregler.  
Regolatore di intensità.



Dual sensor On/Off-anti fog.  
Doppelter Sensorschalter, On/Off.  
Doppio sensore touch, On/Off.  
Antiappannante.

## ÉPSILON 100

- 594 06 100 L Épsilon 100 White  
with side towel rail / Mit seitlichem Handtuchhalter  
/ con porta asciugamani laterale
- 410 00 101 Siphon Chrome / Siphon / Sifone  
138 24 101 Flow 100 f40 Natural Oak  
246 00 100 Verona  
412 06 800 Combi Chrome - White

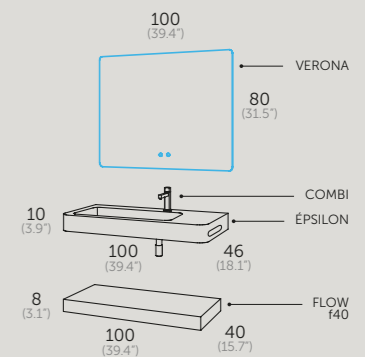

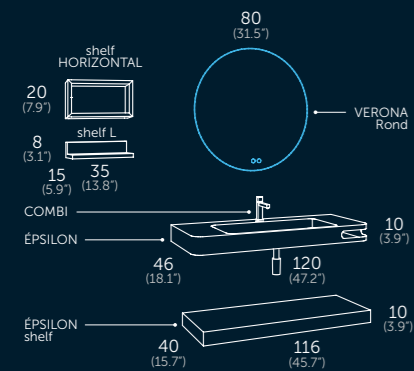

## ÉPSILON 120

- 594 03 120 E Épsilon 120 Anthracite  
with corner towel rail / Mit Eckhandtuchhalter  
/ con porta asciugamani angolare
- 410 03 101 Siphon Brushed Gold / Siphon / Sifone  
594 25 121 Épsilon Shelf Leaf 120 / Regal / Scaffale  
247 00 080 Verona Rond
- 112 47 505 Shelf Horizontal Leaf / Horizontales Regal /  
Scaffale Orizzontale
- 112 47 520 Shelf L Leaf / Regal L / Scaffale L  
412 00 802 Gold Combi



Matte lacquered finish. Matt lackiert.  
Laccato opaco.



Anti fog system. Anti-Beschlag-System.  
Sistema antiappannamento.



Ambient light. Umgebungslicht.  
Luce ambiente.



Intensity control. Intensitätsregler.  
Regolatore di intensità.



Dual sensor On/Off-anti fog. Doppelter  
Sensorschalter. On/Off. Doppio sensore  
di con tatto. On/Off. Antiappannante.

15 FINISHES



## ÉPSILON 60 (23.62")

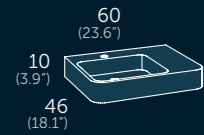

Finishes	Reference*
● White	594 06 060
● Mist	594 22 060
● Anthracite	594 03 060
● Black	594 02 060
● Beige	594 05 060
● Mink	594 19 060
● Soil	594 20 060
● Flower	594 26 060
● Sunset	594 08 060
● Leaf	594 25 060
● Garden	594 73 060
● Island	594 23 060
● Blue Space	594 10 060
● Metallic Gold	594 16 060
● Metallic Lead	594 17 060

## ÉPSILON 80 (31.49")

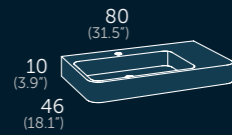

Finishes	Reference*
● White	594 06 080
● Mist	594 22 080
● Anthracite	594 03 080
● Black	594 02 080
● Beige	594 05 080
● Mink	594 19 080
● Soil	594 20 080
● Flower	594 26 080
● Sunset	594 08 080
● Leaf	594 25 080
● Garden	594 73 080
● Island	594 23 080
● Blue Space	594 10 080
● Metallic Gold	594 16 080
● Metallic Lead	594 17 080

## ÉPSILON 100 (39.37")

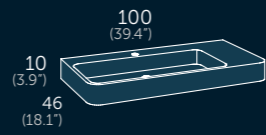

Finishes	Reference*
● White	594 06 100
● Mist	594 22 100
● Anthracite	594 03 100
● Black	594 02 100
● Beige	594 05 100
● Mink	594 19 100
● Soil	594 20 100
● Flower	594 26 100
● Sunset	594 08 100
● Leaf	594 25 100
● Garden	594 73 100
● Island	594 23 100
● Blue Space	594 10 100
● Metallic Gold	594 16 100
● Metallic Lead	594 17 100

## ÉPSILON 120 (47.24")

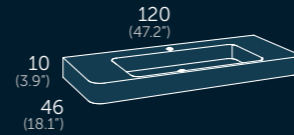

Finishes	Reference*
● White	594 06 120
● Mist	594 22 120
● Anthracite	594 03 120
● Black	594 02 120
● Beige	594 05 120
● Mink	594 19 120
● Soil	594 20 120
● Flower	594 26 120
● Sunset	594 08 120
● Leaf	594 25 120
● Garden	594 73 120
● Island	594 23 120
● Blue Space	594 10 120
● Metallic Gold	594 16 120
● Metallic Lead	594 17 120

## SHELF 60 (23.62")

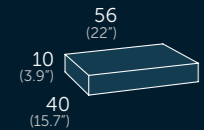

Finishes	Reference
● White	594 06 061
● Mist	594 22 061
● Anthracite	594 03 061
● Black	594 02 061
● Beige	594 05 061
● Mink	594 19 061
● Soil	594 20 061
● Flower	594 26 061
● Sunset	594 08 061
● Leaf	594 25 061
● Garden	594 73 061
● Island	594 23 061
● Blue Space	594 10 061
● Metallic Gold	594 16 061
● Metallic Lead	594 17 061

## SHELF 80 (31.49")

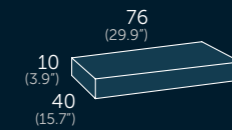

Finishes	Reference
● White	594 06 081
● Mist	594 22 081
● Anthracite	594 03 081
● Black	594 02 081
● Beige	594 05 081
● Mink	594 19 081
● Soil	594 20 081
● Flower	594 26 081
● Sunset	594 08 081
● Leaf	594 25 081
● Garden	594 73 081
● Island	594 23 081
● Blue Space	594 10 081
● Metallic Gold	594 16 081
● Metallic Lead	594 17 081

## SHELF 100 (39.37")



Finishes	Reference
● White	594 06 101
● Mist	594 22 101
● Anthracite	594 03 101
● Black	594 02 101
● Beige	594 05 101
● Mink	594 19 101
● Soil	594 20 101
● Flower	594 26 101
● Sunset	594 08 101
● Leaf	594 25 101
● Garden	594 73 101
● Island	594 23 101
● Blue Space	594 10 101
● Metallic Gold	594 16 101
● Metallic Lead	594 17 101

## SHELF 120 (47.24")



Finishes	Reference*
● White	594 06 121
● Mist	594 22 121
● Anthracite	594 03 121
● Black	594 02 121
● Beige	594 05 121
● Mink	594 19 121
● Soil	594 20 121
● Flower	594 26 121
● Sunset	594 08 121
● Leaf	594 25 121
● Garden	594 73 121
● Island	594 23 121
● Blue Space	594 10 121
● Metallic Gold	594 16 121
● Metallic Lead	594 17 121

### \*options / Optionen / opzioni:

#### ● TOWEL RAIL / Handtuchhalter / Portasciugamani:

The towel rail can be positioned on the right-hand side or in the right-hand corner. With the measurement of 120, it can fit in both positions. Add to the reference: Side towel rail (L), corner towel rail (E), double towel rail (D).

The towel rail can be positioned on the right-hand side or in the right-hand corner. With the measurement of 120, it can fit in both positions. Zur Referenz hinzufügen: Seitlicher Handtuchhalter (L), Eck-Handtuchhalter (E), doppelter Handtuchhalter (D).

Il portasciugamani può essere posizionato sul lato destro o nell'angolo destro. Nella misura di 120 cm, può essere installato in entrambi gli angoli. Aggiungere alla referenza: Portasciugamani laterale (L), portasciugamani angolare (E), doppio portasciugamani (D).

#### ● WITHOUT TAP HOLE / Ohne Hahnloch / Senza foro per rubinetto:

Add to the reference: No tap hole (G). Zur Referenz hinzufügen: Ohne Hahnloch (G). Aggiungere alla referenza: Senza foro per rubinetto (G).

#### ● OVERFLOW OPTION / Überlaufoption / Opzione di troppopieno



Washbasins and shelves | Waschbecken and Regale | Lavabi e scaffali:  
White and Black in stock.  
Weiß und Schwarz auf Lager.  
Bianco e Nero disponibili a magazzino.

Washbasins with towel rail | Waschbecken mit Handtuchhalter  
s| Lavabi con portasciugamani:  
White and Black with corner towel rail in stock.  
Weiß und Schwarz mit Eck-Handtuchhalter auf Lager.  
Bianco e Nero con portasciugamani angolare disponibili a magazzino.

Made of acrylic mineral filler with polyurethane coating. The shelf is made of MDF lacquer. Invisible supports are included.  
Hergestellt aus mineralischem Acrylfüllstoff mit Polyurethan-Beschichtung. Das Regal ist aus lackiertem MDF gefertigt. Unsichtbare Halterungen sind enthalten.  
Realizzato in riempitivo minerale acrilico con rivestimento in poliuretano. La mensola è realizzata in MDF laccato. Supporti invisibili inclusi.

## 60 cm (23.62")

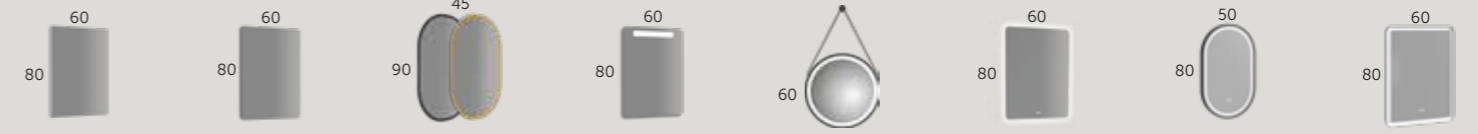

SUN	NITRO	SOUL	RAIN LED	AURA STRAP LED	VERONA LED	JAZZ LED	ORION / OSIRIS LED
Reference 204 00 060	Reference 241 00 060	Reference ● BLACK 239 02 090 ● GOLD 239 72 090	Reference 269 00 060	Reference 251 02 060	Reference 246 00 060	Reference 271 02 050	Reference ● Solid Surface 210 01 060 ● Resin Colour 211 XX 060

## 80 cm (31.49")

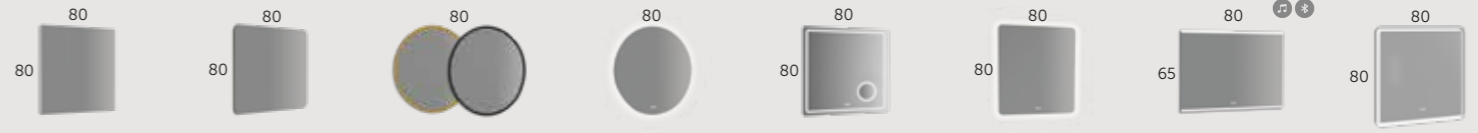

SUN	NITRO	ROND	VERONA ROND LED	COSMOS LED	VERONA LED	SPOTY LED	ORION / OSIRIS LED
Reference 204 00 080	Reference 241 00 080	Reference ● BLACK 244 02 080 ● GOLD 244 72 080	Reference 247 00 080	Reference 270 00 080	Reference 246 00 080	Reference 267 00 080	Reference ● Solid Surface 210 01 080 ● Resin Colour 211 XX 080

## 100 cm (39.37")



SUN	NITRO	ROND	VERONA ROND LED	COSMOS LED	VERONA LED	SPOTY LED	ORION / OSIRIS LED
Reference 204 00 100	Reference 241 00 100	Reference ● BLACK 244 02 100 ● GOLD 244 72 100	Reference 247 00 100	Reference 270 00 100	Reference 246 00 100	Reference 267 00 100	Reference ● Solid Surface 210 01 100 ● Resin Colour 211 XX 100

## 120 cm (47.24")



SUN	NITRO	SOUL	RAIN LED	COSMOS LED	VERONA LED	SPOTY LED	SKYLINE 120 cabinet
Reference 204 00 120	Reference 241 00 120	Reference ● BLACK 239 02 080 ● GOLD 239 72 080	Reference 269 00 120	Reference 270 00 120	Reference 246 00 120	Reference 267 00 120	Reference ● Matte White 341 35 120 More colours on page: 422 3 Doors

### accessories / Zubehör / complementi



COMBI tap	KUDO tap	WALL-MOUNTED tap	SIPHON black	DRAIN clic clac	DRAIN clic clac	ESTHER BLACK 45	AINHOA 74
Reference ● Chrome 412 00 800 ● Black 412 00 801 ● Gold 412 00 802 ● Full Color 412 XX 803	Reference ● Brushed Steel 412 04 810 ● Black 412 02 810 ● Brushed Gold 412 03 810 ● Full Color 412 XX 811	Reference ● Chrome 412 00 808 ● Black 412 02 808 ● Gold 412 03 808	Reference ● Chrome 410 00 101 ● Black 410 02 101 ● Brushed Gold 410 03 101	Reference ● Black 410 02 203 ● White 410 01 203 ● Brushed Gold 410 03 203	Reference ● Colour 409 XX 203	Reference 400 02 191	Reference 400 00 152

## MARA FINISHES (15 COLOURS)

Replace the XX by the chosen colour code.  
Ersetzen Sie XX durch den Code der ausgewählten Farbe.  
Sostituire l'XX con il codice colore scelto.

White 06	Mist 22	Anthracite 03	Black 02	Beige 05
Beige Gris 19	Soil 20	Sunset 08	Flower 26	Leaf 25
Garden 73	Island 23	Blue Space 10	Metallic Gold 16	Metallic Lead 17



## COMPACT NATURAL STONE

# STONE.COMPACT

### Closer to nature.

The new Stone Compact range of basins and plinths countertops is made from **natural compact stone**, which provides a level of strength and durability superior to other materials. The external coating protects it from all kinds of external agents and ensures that the texture, colour and feel of the stone is kept intact. It also prevents stains and makes cleaning easier, allowing the use of any cleaning products, however aggressive they are. Nevertheless, it is always recommended to use neutral products and non-scratch sponges.

### Die Natur näher bei dir.

Die neue Stone Compact-Reihe von Waschbecken und Arbeitsplatten besteht aus **natürlichem Kompaktstein**, der eine höhere Festigkeit und Haltbarkeit als andere Materialien bietet. Die äußere Beschichtung schützt vor äußeren Einflüssen und bewahrt die Textur, Farbe und Haptik des Steins. Sie verhindert zudem Flecken und erleichtert die Reinigung, sodass auch aggressive Reinigungsmittel verwendet werden können. Es wird jedoch immer empfohlen, neutrale Produkte und nicht scheuernde Schwämme zu verwenden.

### La natura più vicina a te.

La nuova gamma Stone Compact di lavabi e piani di lavoro è realizzata in **pietra compatta naturale**, offrendo una resistenza e una durata superiori rispetto ad altri materiali. Il rivestimento esterno protegge da agenti esterni e mantiene intatti la texture, il colore e il tocco della pietra. Inoltre, previene le macchie e facilita la pulizia, consentendo l'uso di prodotti di pulizia anche aggressivi. Tuttavia, è sempre consigliato utilizzare prodotti neutri e spugne non abrasive.

### FINISHES / OBERFLÄCHEN / FINITURE

50

Calacatta

52

Polar Grey

55

Marquina Black

56

Statuary White

57

White

61

Black



On request / auf Anfrage / su richiesta

Printed colours are approximate and may vary from originals.  
Die wiedergegebenen Farben sind ungefähr und können von den Originalen abweichen.  
I colori riprodotti sono approssimativi e potrebbero differire dagli originali.

# STONEPLUS

## WASHBASIN

### 560 XX 000

Width	Sinks
from 61 to 65	1 sink
from 66 to 75	1 sink
from 76 to 85	1 sink
from 86 to 95	1 sink
from 96 to 105	1 sink
from 106 to 115	1 sink
from 116 to 125	1 sink
from 116 to 125	2 sinks
from 126 to 135	1 sink
from 126 to 135	2 sinks
from 136 to 145	1 sink
from 136 to 145	2 sinks

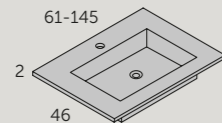

## PLINTHED WASHBASIN

### 561 XX 000

Width	Sinks
from 61 to 65	1 sink
from 66 to 75	1 sink
from 76 to 85	1 sink
from 86 to 95	1 sink
from 96 to 105	1 sink
from 106 to 115	1 sink
from 116 to 125	1 sink
from 116 to 125	2 sinks
from 126 to 135	1 sink
from 126 to 135	2 sinks
from 136 to 145	1 sink
from 136 to 145	2 sinks
from 146 to 155	1 sink
from 146 to 155	2 sinks

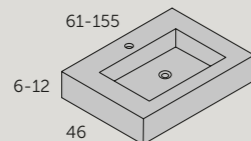

## INVISIBLE BRACKETS

Measure	Reference
21x30	560 00 043

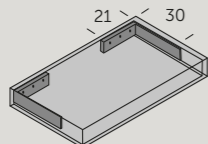

From 140 cm onwards, the use of 2 sets of brackets is required.

Ab 140 cm ist die Verwendung von 2 Verdeckte Befestigung erforderlich.

Da 140 cm in poi, è necessario l'uso di 2 set di staffe.

Calacatta 50	White 57	Polar Grey 52
Black 61	Marquina Black 55	

## STONEPLUS 120

561 50 000	Stoneplus Plinthed 1s Calacatta / Wandbecken / Lavabo con gonna
560 00 043	Invisible brackets / Verdeckte Befestigung / Squadre invisibili
410 00 101	Siphon Chrome / Siphon / Sifone
112 24 210	Landes Countertop 100 Natural Oak / Waschtischplatte / Piano
112 24 104 LC	Landes Mod. 1D 100 Natural Oak / Modul 1 Schublade / Modulo 1 Cassetto
262 00 120	Tower
112 24 435	Landes Medium Natural Oak / Mittel / Medio
412 00 800	Combi Chrome

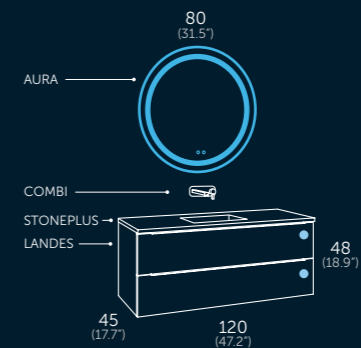
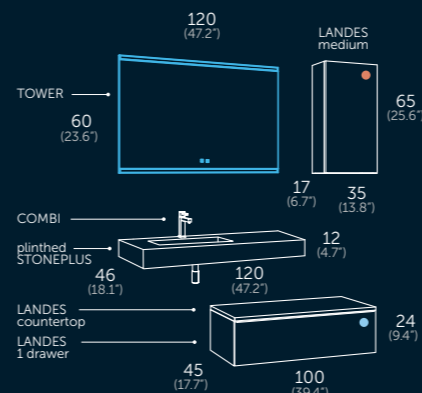

## STONEPLUS 120

561 55 000	Stoneplus 1s Marquina Black
112 35 121 LN	Landes Mod. 2D 1 sink White / Modul 2 Schublade 1s
250 02 080	Aura
412 02 808	Combi Wall-Mounted Black



# ÁTIKA

## PLINTHED WASHBASIN 1 SINK

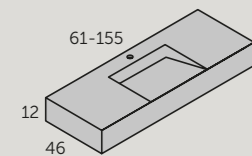

**WITHOUT TOWEL RAIL**  
563 XX 000

Width  
from 61 to 65  
from 66 to 75  
from 76 to 85  
from 86 to 95  
from 96 to 105  
from 106 to 115  
from 116 to 125  
from 126 to 135  
from 136 to 145  
from 146 to 155

Brackets NOT included. Halterungen NICHT inbegriffen. Staffe NON incluse.

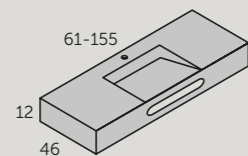

**WITH TOWEL RAIL**  
563 XX 000

Width  
from 61 to 65  
from 66 to 75  
from 76 to 85  
from 86 to 95  
from 96 to 105  
from 106 to 115  
from 116 to 125  
from 126 to 135  
from 136 to 145  
from 146 to 155

## PLINTHED WASHBASIN 2 SINKS

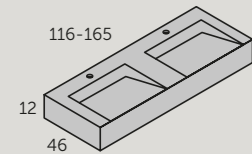

**WITHOUT TOWEL RAIL**  
563 XX 000

Width  
from 116 to 125  
from 126 to 135  
from 136 to 145  
from 146 to 155  
from 156 to 165

Brackets NOT included. Halterungen NICHT inbegriffen. Staffe NON incluse.

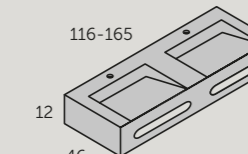

**WITH TOWEL RAIL**  
563 XX 000

Width  
from 116 to 125  
from 126 to 135  
from 136 to 145  
from 146 to 155  
from 156 to 165

## INVISIBLE BRACKETS

Measure Reference  
21x30 560 00 043

From 140 cm onwards, the use of 2 sets of brackets is required.

Ab 140 cm ist die Verwendung von 2 Verdeckte Befestigung erforderlich.

Da 140 cm in poi, è necessario l'uso di 2 set di staffe.

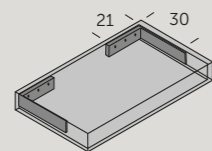

Calacatta 50	White 57	Polar Grey 52
Black 61	Marquina Black 55	Statuary White 56

To complete the order, replace the XX with the code of the selected colour. It is necessary to provide a drawing indicating the location of the drilling for the tap and the drain. All these products are available on request.

Um den Bestellung zu vervollständigen, ersetzen Sie XX durch den Code der ausgewählten Farbe. Es ist erforderlich, eine Zeichnung bereitzustellen, die die Position der Bohrung für den Wasserhahn und den Abfluss angibt. Alle diese Produkte sind auf Anfrage erhältlich.

Per completare l'ordine, sostituire XX con il codice del colore selezionato. È necessario fornire un disegno che indichi la posizione della foratura per il rubinetto e lo scarico. Tutti questi prodotti sono disponibili su richiesta.

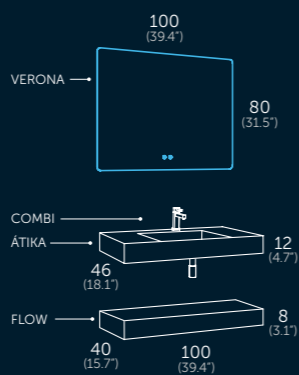

## ÁTIKA 100

563 57 000 Átika 1 sink White 100 / Wandbecken / Lavabo con gonna

560 00 043 Invisible Brackets / Verdeckte Befestigung / Squadre invisibili

138 24 101 Flow f40 Natural Oak

246 00 100 Verona

410 00 101 Chrome Siphon / Siphon / Sifone

412 00 800 Combi Chrome

## ÁTIKA 160

563 56 000

560 00 043

112 45 216

112 45 084 LG

246 00 060

410 03 101

412 00 802

Átika 2 sinks Statuary White 160 with towel rail / Handtuchhalter / Portasciugamani

Invisible brackets / Verdeckte Befestigung / Squadre invisibili

Landes Countertop Anthracite 160 / Waschtischplatte / Piano

Verona Mod. 1D Anthracite 80 / Modul 1 Schublade 80 / Modulo 1 Cassetto 80

Verona

Siphon Brushed Gold / Siphon / Sifone

Combi Gold

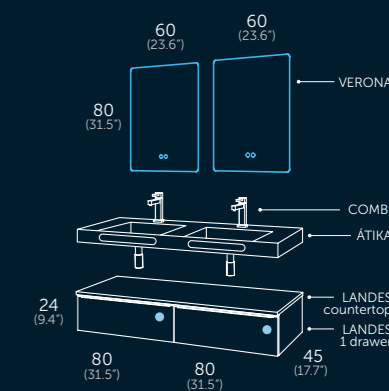

# UMMA

## COUNTERTOPS

### 570 XX 000

Width	Sinks
from 40 to 65	1 sink
from 66 to 75	1 sink
from 76 to 85	1 sink
from 86 to 95	1 sink
from 96 to 105	1 sink
from 106 to 115	1 sink
from 116 to 125	1 sink
from 116 to 125	2 sinks
from 126 to 135	1 sink
from 126 to 135	2 sinks
from 136 to 145	1 sink
from 136 to 145	2 sinks
from 146 to 155	1 sink
from 146 to 155	2 sinks

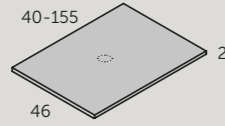

## PLINTH COUNTERTOP

### 571 XX 000

Width	Sinks
from 40 to 65	1 sink
from 66 to 75	1 sink
from 76 to 85	1 sink
from 86 to 95	1 sink
from 96 to 105	1 sink
from 106 to 115	1 sink
from 116 to 125	1 sink
from 116 to 125	2 sinks
from 126 to 135	1 sink
from 126 to 135	2 sinks
from 136 to 145	1 sink
from 136 to 145	2 sinks
from 146 to 155	1 sink
from 146 to 155	2 sinks

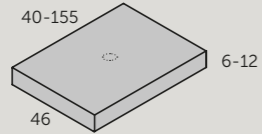

## INVISIBLE BRACKETS

Measure	Reference
21x30	560 00 043

From 140 cm onwards, the use of 2 sets of brackets is required.

Ab 140 cm ist die Verwendung von 2 Verdeckte Befestigung erforderlich.

Da 140 cm in poi, è necessario l'uso di 2 set di staffe.

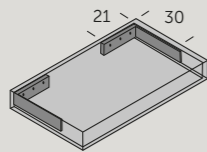

Calacatta 50	White 57	Polar Grey 52
Black 61	Marquina Black 55	Statuary White 56

To complete the order, replace the XX with the code of the selected colour. It is necessary to provide a drawing indicating the location of the drilling for the tap and the drain. All these products are available on request.

Um den Bestellung zu vervollständigen, ersetzen Sie XX durch den Code der ausgewählten Farbe. Es ist erforderlich, eine Zeichnung bereitzustellen, die die Position der Bohrung für den Wasserhahn und den Abfluss angibt. Alle diese Produkte sind auf Anfrage erhältlich.

Per completare l'ordine, sostituire XX con il codice del colore selezionato. È necessario fornire un disegno che indichi la posizione della foratura per il rubinetto e lo scarico. Tutti questi prodotti sono disponibili su richiesta.

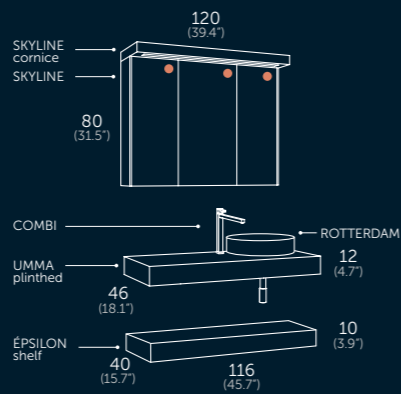

## UMMA 120

571 56 000	Plinth Umma Statuary White 120 / Wandbecken / Lavabo con gonnia
560 00 043	Invisible Brackets / Verdeckte Befestigung / Squadre invisibili
410 00 101	Siphon Chrome / Siphon / Sifone
594 10 121	Épsilon Shelf Blue Space / Regal / Scaffale
341 35 120	Skyline White
341 35 121	Cornice LED White
507 01 004	Rotterdam
412 00 805	Combi Tall Chrome / Hoch / Alto

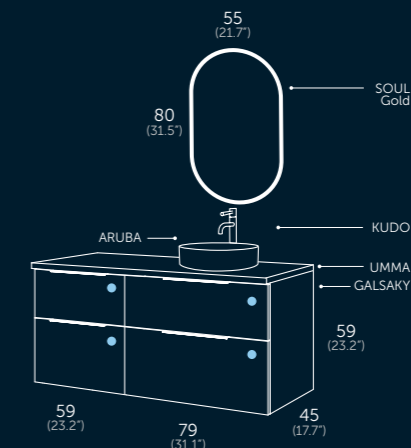

## UMMA 140

570 52 000	Umma Polar Grey
151 47 080 G	Galsaky Leaf 80
151 47 060 G	Galsaky Leaf 60
581 25 037	Aruba Leaf
239 72 080	Soul Gold
412 03 815	Kudo Tall Brushed Gold / Hoch Gebürstet / Alto Spazzolato



# PETRA

## WASHBASIN DEPTH 35 CM

567 XX 000

Width  
 from 35 to 45  
 from 46 to 55  
 from 56 to 65  
 from 66 to 75  
 from 76 to 85  
 from 86 to 95  
 from 96 to 105  
 from 106 to 115  
 from 116 to 125

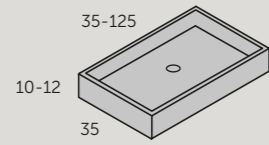

## WASHBASIN DEPTH 45 CM

568 XX 000

Width  
 from 35 to 45  
 from 46 to 55  
 from 56 to 65  
 from 66 to 75  
 from 76 to 85  
 from 86 to 95  
 from 96 to 105  
 from 106 to 115  
 from 116 to 125

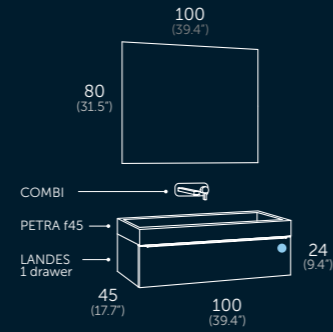
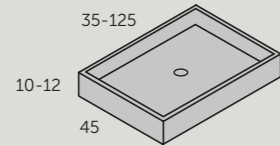

## PETRA f45

568 52 000 Petra f45 Polar Grey 100  
 112 45 103 LN Landes Module 1 Drawer Anthracite / Modul 1 Schublade / Modulo 1 Cassetto  
 204 00 100 Sun  
 412 02 808 Combi Wall-Mounted Black

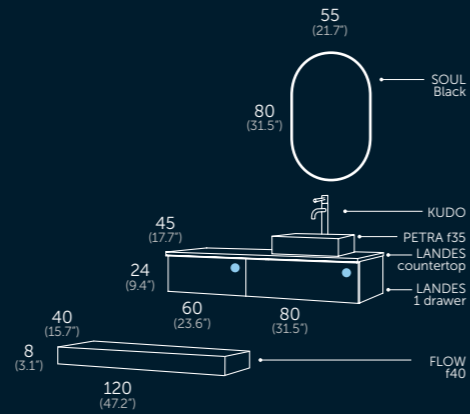

## PETRA f35

567 55 000 Petra F35 Marquina Black 40  
 112 24 214 Landes Countertop Natural Oak 140 / Waschtischplatte / Piano  
 425 14 080 Reinforcement Bar 80 / Waschtischplatten-Stabilisierung / Barra di rinforzo  
 112 24 083 LN Landes Module 1 Drawer with drain trap Natural Oak 80 / Modul 1 Schublade / Modulo 1 Cassetto  
 112 24 064 LN Landes Module 1 Drawer without drain trap Natural Oak 60 / Modul 1 Schublade / Modulo 1 Cassetto  
 138 24 120 Flow f40 Natural Oak 120  
 239 02 080 Soul Black  
 412 02 815 Kudo Tall Black / Hoch / Alto



Calacatta 50	White 57	Polar Grey 52
Black 61	Marquina Black 55	

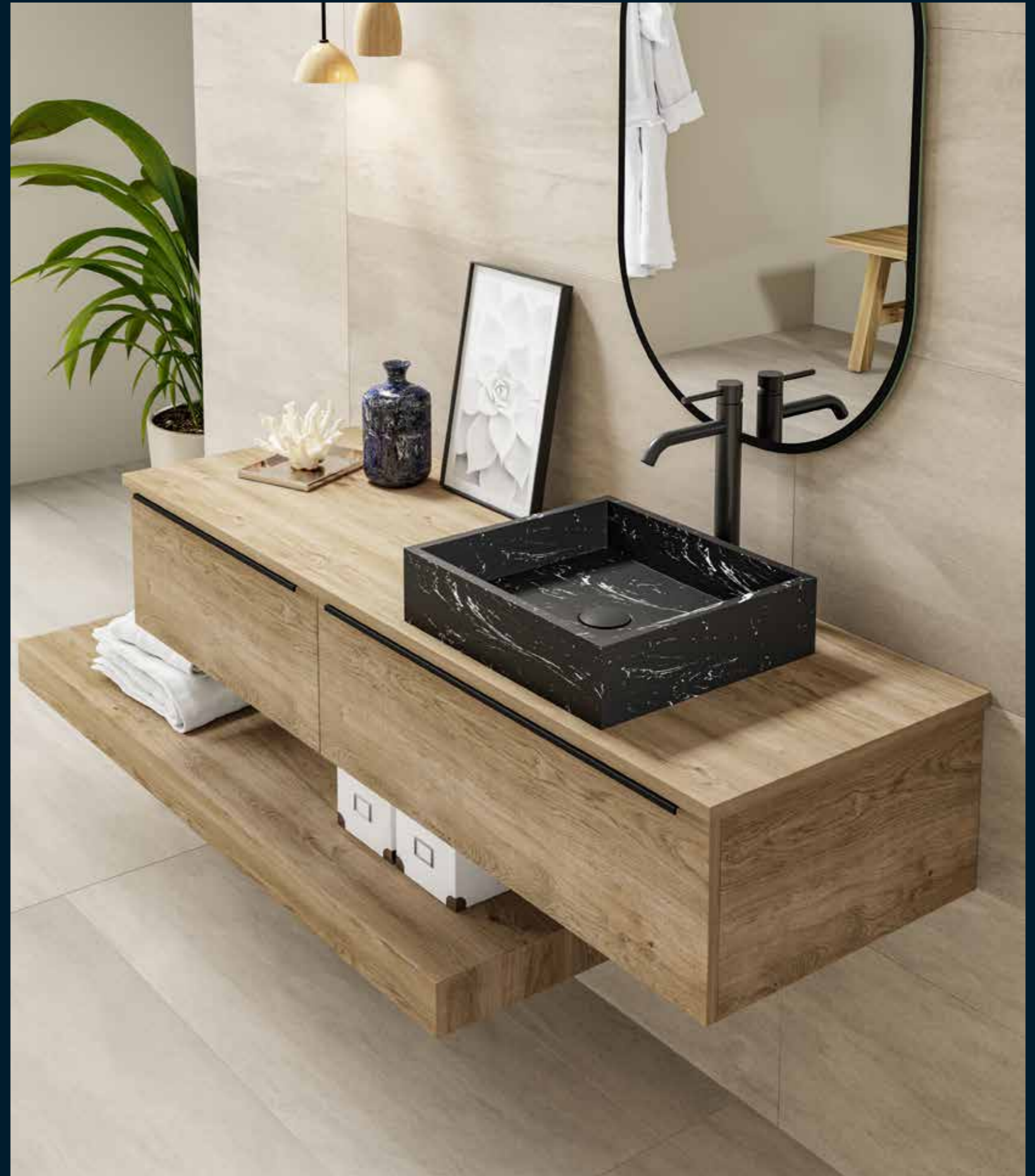

To complete the order, replace the XX with the code of the selected colour. It is necessary to provide a drawing indicating the location of the drilling for the tap and the drain. All these products are available on request.

Um den Bestellung zu vervollständigen, ersetzen Sie XX durch den Code der ausgewählten Farbe. Es ist erforderlich, eine Zeichnung bereitzustellen, die die Position der Bohrung für den Wasserhahn und den Abfluss angibt. Alle diese Produkte sind auf Anfrage erhältlich.

Per completare l'ordine, sostituire XX con il codice del colore selezionato. È necessario fornire un disegno che indichi la posizione della foratura per il rubinetto e lo scarico. Tutti questi prodotti sono disponibili su richiesta.

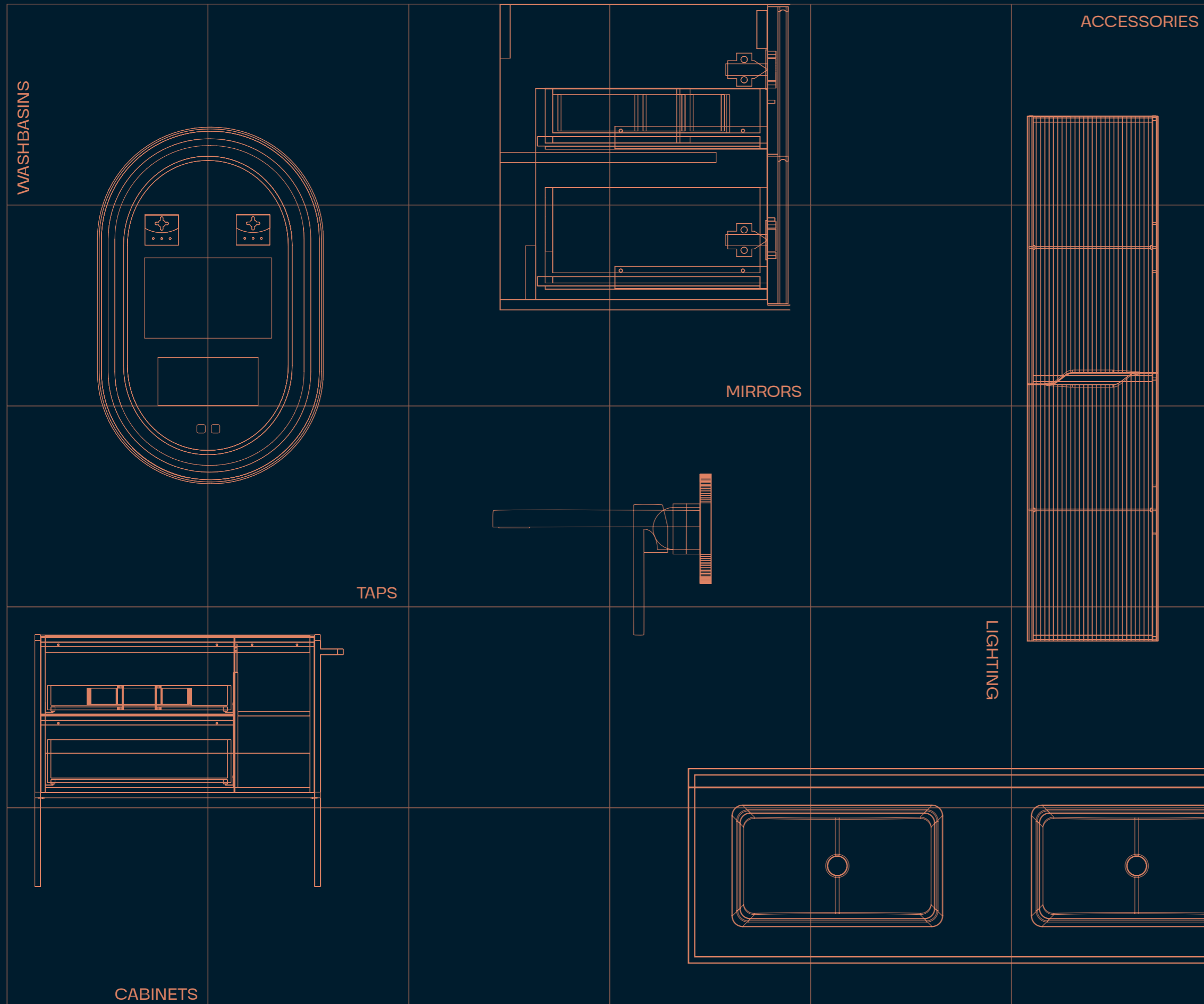

## TECHNICAL SPECIFICATIONS

TECHNISCHE SPEZIFIKATIONEN  
SPECIFICHE TECNICHE

<b>CERAMIC WASHBASINS</b> / Keramikbecken / Lavabi Ceramica	XXX
<b>TAPS</b> / Armaturen / Rubinetti	XXX
<b>MIRRORS</b> / Spiegel / Specchi	XXX
<b>SIDE CABINETS</b> / Schränke / Armadietti	XXX
<b>LIGHTING</b> / Beleuchtung / Illuminazione	XXX
<b>ACCESSORIES</b> / Zubehör / Complementi	XXX
<b>AUXILIARIES</b> / Beistellmöbel / Mobili Ausiliari	XXX
<b>WASHBASIN ACCESSORIES</b> / Waschtisch-Zubehör / Complementi per lavabo	XXX
<b>TECHNICAL SPECIFICATIONS</b> / Technische Spezifikationen / Specifiche tecniche	XXX
<b>FINISHES</b> / Oberflächen / Finiture	XXX

Visit our webside:

[WWW.COYCAMA.COM](http://WWW.COYCAMA.COM)

Access technical data sheets, 3D files, instructions, and all updated information.  
Greifen Sie auf technische Datenblätter, 3D-Dateien, Anleitungen und alle aktuellen Informationen zu.  
Accedi alle schede tecniche, file 3D, istruzioni e tutte le informazioni aggiornate.



 YouTube

**Installation and adjustment.**  
Step-by-step assembly instructions.

# CERAMIC WASHBASINS

KERAMIKBECKEN / LAVABI CERAMICA

## ONIX NEW / QUATTRO OVERFLOW COVER / ÜBERLAUFDECKEL / COPERTURA DEL TROPPO PIENO

Finish	Reference
CHROME glossy	405 00 000
BLACK matte	405 02 000
WHITE glossy	405 01 000
GOLD matte	405 03 000

Chrome cover included with the washbasin.  
Not compatible with Onix New offset 80 (60+20) and 80 (20+60) cm.



### ONIX NEW CENTRED SINK

cm	Reference
60	550 01 060
70	550 01 070
80	550 01 080
90	550 01 090
100	550 01 100
120	550 01 120

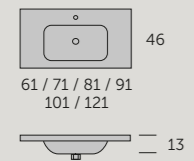

### ONIX NEW TWO SINKS

cm	Reference
120	550 01 122

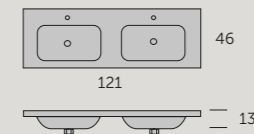

### ONIX NEW OFFSET SINK

cm	Reference
80 (60+20)	550 01 081
90 (70+20)	550 01 091
100 (70+30)	550 01 101
120 (60+60)	550 01 121
80 (20+60)	550 01 083
90 (20+70)	550 01 093
100 (30+70)	550 01 103
120 (60+60)	550 01 123

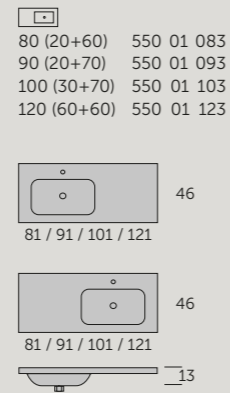

### QUATTRO CERAMIC

cm	Reference
60	522 01 060
80	522 01 080
100	522 01 100

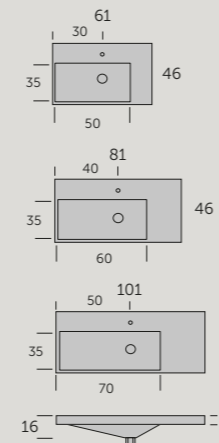

### f40 ONIX NEW REDUCED DEPTH

cm	Reference
60	551 01 060
70	551 01 070
80	551 01 080

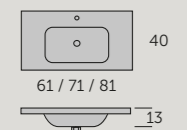

### ALBA 50 REDUCED DEPTH

cm	Reference
50	510 01 050

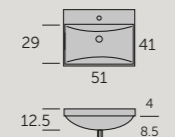

### ELSA 50/60 REDUCED DEPTH

cm	Reference
50	554 01 050
60	554 01 060

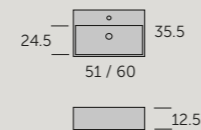

### BALI 45/55 REDUCED DEPTH

cm	Reference
45 x 31	515 01 045
55 x 37	515 01 055

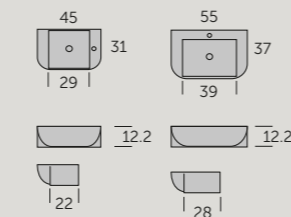

# CERAMIC COUNTERTOP BASIN

AUFSATZWASCHBECKEN / LAVABO DA APPOGGIO

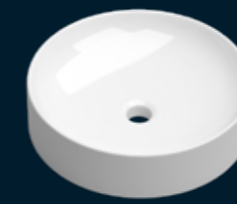

### ROTTERDAM CERAMIC

cm	Reference
43	507 01 004

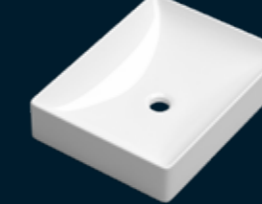

### ESTAMBUL CERAMIC

cm	Reference
50 x 38	507 01 005

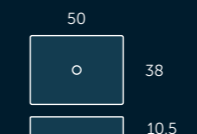

### OTTO CERAMIC

cm	Reference
40	530 01 008

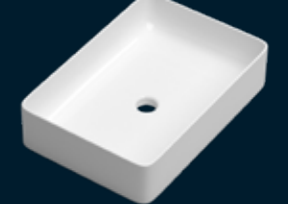

### TRE CERAMIC

cm	Reference
51 x 35	530 01 035
61 x 35	530 01 036

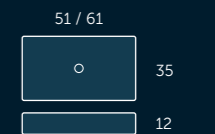

### SEI CERAMIC

cm	Reference
39 x 39	530 01 006

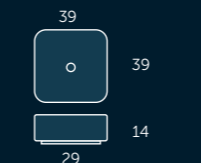

### DUE CERAMIC

cm	Reference
46 x 33	530 01 002

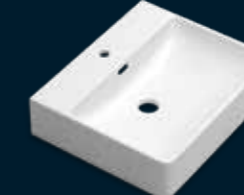
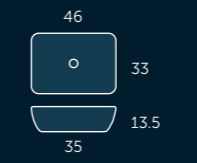

### NOVE CERAMIC

cm	Reference
41 x 42	530 01 094
50 x 42	530 01 095
60 x 42	530 01 096
80 x 42	530 01 097

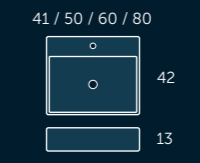



# CERAMIC COLOUR

## 15 FINISHES MARA

- Ceramic sinks with Kromtek acrylic coating. Matte finish and antibacterial treatment. High resistance and easy to clean.
- Keramikwaschbecken mit Kromtek-Acrylbeschichtung. Mattes Finish und antibakterielle Behandlung. Hohe Widerstandsfähigkeit und leichte Reinigung.
- Lavabi in ceramica con rivestimento acrilico Kromtek. Finitura opaca e trattamento antibatterico. Alta resistenza e facile da pulire.

Matte White 06	Mist 22	Anthracite 03	Black 02	Beige 05
Mink 19	Soil 20	Flower 26	Sunset 08	Leaf 25
Garden 73	Island 23	Blue Space 10	Met. Gold 16	Met. Lead 17



White finish (06) and Black (02) in stock. Other finishes available upon request.  
Weiße Oberfläche (06) und Schwarz (02) auf Lager. Andere Oberflächen auf Anfrage erhältlich.  
Finitura bianca (06) e nera (02) disponibili in stock. Altre finiture disponibili su richiesta.



## CERAMIC COLOUR | KERAMIKBECKEN FARBE / CERAMICA COLORE

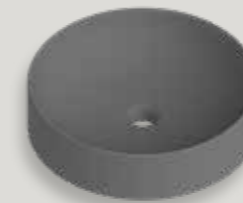

### ROTTERDAM COLOUR

cm Reference  
43 535 XX 004

Replace XX with color code.  
Ersetzen Sie XX durch Farbcodes.  
Sostituire XX con codice colore.

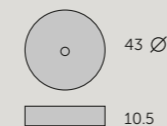

### TRE 50 COLOUR

cm Reference  
51 x 35 535 XX 035

Replace XX with color code.  
Ersetzen Sie XX durch Farbcodes.  
Sostituire XX con codice colore.

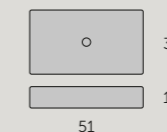

### OTTO COLOUR

cm Reference  
40 535 XX 008

Replace XX with color code.  
Ersetzen Sie XX durch Farbcodes.  
Sostituire XX con codice colore.

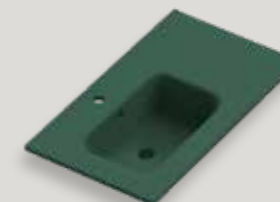
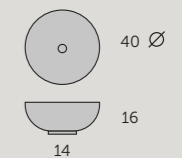

### ONIX NEW COLOUR

cm Reference  
60 552 XX 060  
70 552 XX 070  
80 552 XX 080

80 (60+20) 552 XX 081  
80 (20+60) 552 XX 083

Replace XX with color code.  
Ersetzen Sie XX durch Farbcodes.  
Sostituire XX con codice colore.

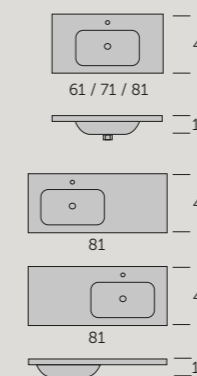

### ONIX NEW f40 COLOUR | REDUCED DEPTH

cm Reference  
60 553 XX 060  
70 553 XX 070  
80 553 XX 080

Replace XX with color code.  
Ersetzen Sie XX durch Farbcodes.  
Sostituire XX con codice colore.

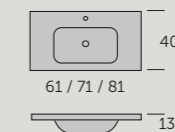

Check the availability of other colour ceramic models.  
Überprüfen Sie die Verfügbarkeit anderer Keramikmodelle in verschiedenen Farben.  
Verifica la disponibilità di altri modelli di ceramica in diverse finiture.

# TAPS

ARMATUREN / RUBINETTI



## Create a tap to your liking.

- Choose from different formats and finishes. Include the single lever or an integral colour coating for the taps.
- Wählen Sie aus verschiedenen Formaten und Ausführungen. Fügen Sie den Einhebelmischer oder eine integrale Farbüberzug für die Armaturen hinzu.
- Scegli tra diversi formati e finiture. Aggiungi il monomando o una rivestimento integrale di colore ai rubinetti.

## 15 MARA FINISHES

Replace XX with colour code.  
Ersetzen Sie XX durch Farbcodes.  
Sostituire XX con codice colore.

White Matte 06	Mist 22	Anthracite 03	Black 02	Beige 05
Mink 19	Soil 20	Flower 26	Sunset 08	Leaf 25
Garden 73	Island 23	Blue Space 10	Met. Gold 16	Met. Lead 17

## COMBI COLOUR HANDLE

- Available for Combi and Combi Tall. Handle-less design. Natural Oak or 15 Mara colours.
- Verfügbar für Combi und Combi Hoch. Hebeldesign ohne Griff. Natur Eiche oder 15 Mara Farben.
- Disponibile per Combi e Combi Alto. Design della mani glia senza pomello. Quercia naturale o 15 colori Mara.



**Colour Handle:** Finish Natural Oak (24) and Black (02) in stock. Other finishes available on request.  
**Farbgriff:** Finish Natur Eiche (24) und Schwarz (02) auf Lager. Andere Ausführungen auf Anfrage.  
**Maniglia colorata:** Finitura Quercia naturale (24) e Nero (02) disponibili in stock. Altri finiture su richiesta.

All taps include installation hoses.

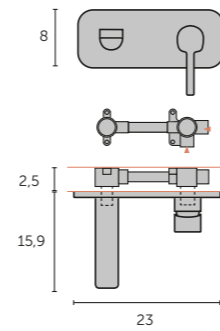
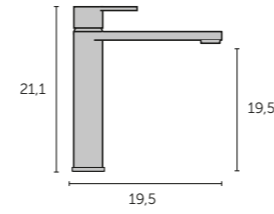
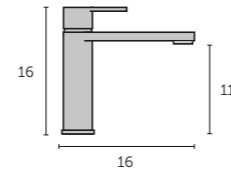

Option for Built-in washbasin connection, see page 434.

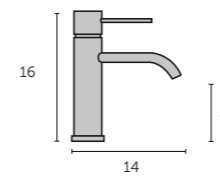

Flexitub hoses | aenor

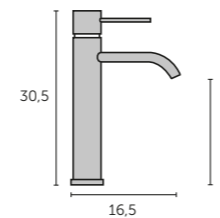

Flexitub hoses | aenor



### COMBI FULL COLOR

Finish Reference  
Colour 412 XX 803



### COMBI TALL FULL COLOR

Finish Reference  
Colour 412 XX 804



## TAPS FULL COLOR 15 FINISHES

Integral acrylic coating.  
Integrierte Acrylbeschichtung.  
Rivestimento acrilico integrale.



### KUDO FULL COLOR

Finish Reference  
Colour 412 XX 811



### KUDO TALL FULL COLOR

Finish Reference  
Colour 412 XX 816



### COMBI CHROME

Mixing-tap Reference  
Chrome 412 00 800  
Natural Oak 412 24 800  
Colour handle 412 XX 800



### COMBI TALL CHROME

Mixing-tap Reference  
Chrome 412 00 805  
Natural Oak 412 24 805  
Colour handle 412 XX 805

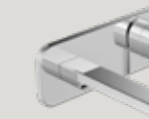

### WALL-MOUNTED COMBI CHROME

Finish Reference  
Chrome 412 00 808



### KUDO STEEL

Finish Reference  
Brushed Steel 412 04 810



### KUDO TALL STEEL

Finish Reference  
Brushed Steel 412 04 815



### COMBI BLACK

Mixing-tap Reference  
Black Matte 412 00 801  
Natural Oak 412 24 801  
Colour handle 412 XX 801



### COMBI TALL BLACK

Mixing-tap Reference  
Black Matte 412 00 806  
Natural Oak 412 24 806  
Colour handle 412 XX 806



### WALL-MOUNTED COMBI BLACK

Finish Reference  
Matte Black 412 02 808



### KUDO BLACK

Finish Reference  
Matte Black 412 02 810



### KUDO TALL BLACK

Finish Reference  
Matte Black 412 02 815



### COMBI GOLD

Mixing-tap Reference  
Gold 412 00 802  
Natural Oak 412 24 802  
Colour handle 412 XX 802



### COMBI TALL GOLD

Mixing-tap Reference  
Gold 412 00 807  
Natural Oak 412 24 807  
Colour handle 412 XX 807

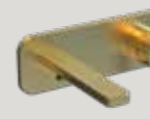

### WALL-MOUNTED COMBI GOLD

Finish Reference  
Gold 412 03 808



### KUDO GOLD

Finish Reference  
Brushed Gold 412 03 810



### KUDO TALL GOLD

Finish Reference  
Brushed Gold 412 03 815

# MIRRORS

SPIEGEL / SPECCHI

At Coycama, mirrors are key elements that elevate your bathroom design. Designed to fit any style, our mirrors combine functionality and aesthetics, seamlessly integrating into any environment and offering a practical and elegant solution to optimize your space.



## ROND

cm	Reference
60	244 00 060
70	244 00 070
80	244 00 080
90	244 00 090
100	244 00 100

60 / 70 / 80 / 90 / 100

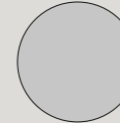

- Glass thickness: 4 mm.
- Glasdicke: 4 mm.
- Spessore del vetro: 4 mm.



## ROND BLACK

cm	Reference
60	244 02 060
70	244 02 070
80	244 02 080
100	244 02 100

60 / 70 / 80 / 100



- Glass thickness: 4 mm.
- Screen-printed edge on the glass.
- Glasdicke: 4 mm.
- Siebdruckkante auf dem Glas.
- Spessore del vetro: 4 mm.
- Bordo serigrafato sul vetro.



## ROND GOLD

cm	Reference
60	244 72 060
70	244 72 070
80	244 72 080
100	244 72 100

60 / 70 / 80 / 100



- Glass thickness: 4 mm.
- Screen-printed edge on the glass.
- Glasdicke: 4 mm.
- Siebdruckkante auf dem Glas.
- Spessore del vetro: 4 mm.
- Bordo serigrafato sul vetro.

**WALL MOUNT BEFESTIGUNG FISSAGGIO**

Mounting system that allows the mirror to be flush with the wall. Rear cutout for placing the connection of the wall light, Ø 20 cm.

Befestigungssystem, das es dem Spiegel ermöglicht, bündig mit der Wand abzuschließen. Hintere Aussparung zur Platzierung der Anschlussdose für die Wandlampe, Ø 20 cm.

Sistema di fissaggio che consente allo specchio di essere a filo con la parete. Taglio posteriore per posizionare la connessione del lampadario, Ø 20 cm.



## SUN WITH WOODEN BACK / MIT HOLZRÜCKEN / CON RETRO IN LEGNO

cm	Reference
50x80	204 00 050
60x80	204 00 060
70x80	204 00 070
80x80	204 00 080
90x80	204 00 090
100x80	204 00 100
120x80	204 00 120

50 / 60 / 70 / 80 / 90 / 100 / 120

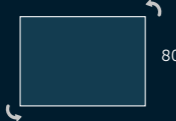

- Glass thickness: 4 mm.
- Hole for connections.
- Invertible.
- Glasdicke: 4 mm.
- Loch für Anschlüsse
- Wendbar
- Spessore del vetro: 4 mm.
- Foro per connessioni
- Reversibile

## MOON

cm	Reference
50x70	200 00 050
60x70	200 00 060
80x70	200 00 080
90x70	200 00 090
100x70	200 00 100

50 / 60 / 80 / 90 / 100



- Glass thickness: 4 mm.
- Invertible
- Glasdicke: 4 mm.
- Wendbar
- Spessore del vetro: 4 mm.
- Reversibile



## SOUL

cm	Reference
45x90	239 00 090
55x80	239 00 080
75x100	239 00 100

45 / 55 / 75



- Glass thickness: 4 mm.
- Invertible
- Glasdicke: 4 mm.
- Wendbar
- Spessore del vetro: 4 mm.
- Reversibile



## SOUL BLACK

cm	Reference
45x90	239 02 090
55x80	239 02 080
75x100	239 02 100

45 / 55 / 75



- Glass thickness: 4 mm.
- Screen-printed edge on the glass.
- Invertible
- Glasdicke: 4 mm.
- Siebdruckkante auf dem Glas.
- Wendbar
- Spessore del vetro: 4 mm.
- Bordo serigrafato sul vetro.
- Reversibile



## SOUL GOLD

cm	Reference
45x90	239 72 090
55x80	239 72 080
75x100	239 72 100

45 / 55 / 75



- Glass thickness: 4 mm.
- Screen-printed edge on the glass.
- Invertible
- Glasdicke: 4 mm.
- Siebdruckkante auf dem Glas.
- Wendbar
- Spessore del vetro: 4 mm.
- Bordo serigrafato sul vetro.
- Reversibile

# MIRRORS

SPIEGEL / SPECCHI



## TOSCANA

cm	Reference
60x80	296 35 060
80x80	296 35 080
100x80	296 35 100
60x80	296 24 060
80x80	296 24 080
100x80	296 24 100
60x80	296 71 060
80x80	296 71 080
100x80	296 71 100
60x80	296 49 060
80x80	296 49 080
100x80	296 49 100

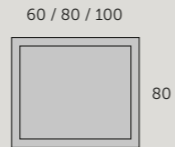

- Glass thickness: 5 mm.
- Invertible
- Glasdicke: 5 mm.
- Wendbar
- Spessore del vetro: 5 mm.
- Reversibile



## NITRO

cm	Reference
50x80	241 00 050
60x80	241 00 060
70x80	241 00 070
80x80	241 00 080
100x80	241 00 100
120x80	241 00 120
140x80	241 00 140

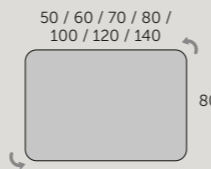

- Glass thickness: 4 mm.
- Invertible
- Glasdicke: 4 mm.
- Wendbar
- Spessore del vetro: 4 mm.
- Reversibile



## VERSA

WITH A WOODEN BACK  
/ MIT HOLZRÜCKEN  
/ CON RETRO IN LEGNO

cm	Reference
45x70	208 00 045
55x70	208 00 055

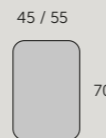

- Glass thickness: 4 mm.
- Hole for connections
- Invertible
- Glasdicke: 4 mm.
- Loch für Anschlüsse
- Wendbar
- Spessore del vetro: 4 mm.
- Foro per connessioni
- Reversibile

# LED MIRRORS

SPIEGEL LED / SPECCHI LED

WITH A RESIN FRAME  
/ MIT EINEM HARZRAHMEN  
/ CON CORNICE IN RESINA



## ORIÓN

FRAME SOLID SURFACE

cm	Solid Surface
60x80	210 01 060
80x80	210 01 080
100x80	210 01 100

## OSIRIS

FRAME RESINA COLOR

cm	Colour Resin
60x80	211 XX 060
80x80	211 XX 080
100x80	211 XX 100

Replace the XX with the color reference  
Ersetzen Sie das XX durch die Farbfref  
Sostituire la XX con il riferimento del colore



On/Off - Anti-fog  
Ein/Aus - Antibeschlag  
On/Off - Antivapore

FINISHES FOR THE RESIN FRAME.

- Solid Surface
- White 06
- Mist 22
- Anthracite 03
- Black 02
- Beige 05
- Mink 19
- Soil 20
- Sunset 08
- Flower 26
- Leaf 25
- Garden 73
- Island 23
- Blue Space 10
- Metallic Gold 16
- Metallic Lead 17

Resin colour available on request.  
Harzfarbe auf Anfrage erhältlich.  
Colore della resina disponibile su richiesta.



## VERONA

cm	Reference	Watts	Lumens
60x80	246 00 060	50	800
70x80	246 00 070	52	800
80x80	246 00 080	54	800
100x80	246 00 100	56	800
120x80	246 00 120	81	800
140x80	246 00 140	100	800

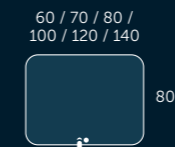

On/Off - Anti-fog  
Ein/Aus - Antibeschlag  
On/Off - Antivapore

## VERONA ROND

cm	Reference	Watts	Lumens
70	247 00 070	36	600
80	247 00 080	40	600
100	247 00 100	58	600

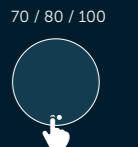

On/Off - Anti-fog  
Ein/Aus - Antibeschlag  
On/Off - Antivapore

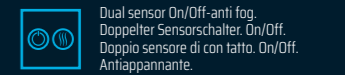
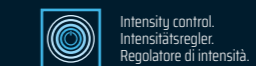
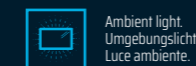
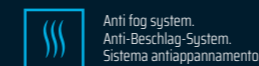

# LED MIRRORS

## SPIEGEL LED / SPECCHI LED



Magnifying zoom in Mirror.  
Lupe 3x Vergrößerung.  
Lente d'ingrandimento 3x.



Ambient light.  
Umgebungslicht.  
Luce ambiente.



Intensity control.  
Intensitätsregler.  
Regolatore di intensità.



Dual sensor On/Off-anti fog.  
Doppelter Sensorschalter. On/Off.  
Doppio sensore di con tatto. On/Off.  
Antiappannante.



Digital clock.  
Digitaluhr.  
Orologio digitale.



Anti fog system.  
Anti-Beschlag-System.  
Sistema antiappannamento.



Bluetooth music player. 2 speakers of 3W each. Musik Player integriert. Bluetooth Anschluss. 2 Lautsprecher je mit 3W. Lettore musicale integrato, connessione a Bluetooth. 2 altoparlanti 3W ciascuno.



Integrated speakers  
Integrierte Lautsprecher  
Altoparlanti integrati  
2 x 3W

### SPOTY

cm	Reference	Watts	Lumens
80x65	267 00 080	15	756
100x65	267 00 100	15	972
120x65	267 00 120	20	1188

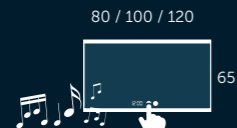

On/Off - Anti-fog  
Ein/Aus - Antibeschlag  
On/Off - Antivapore

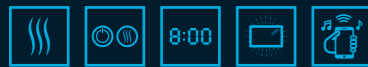

### JAZZ

cm	Reference	Watts	Lumens
50x80	271 02 050	20	1936

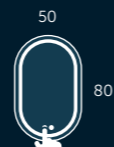

On/Off - Anti-fog  
Ein/Aus - Antibeschlag  
On/Off - Antivapore



### TOWER

cm	Reference	Watts	Lumens
120x60	262 00 120	15	1242
140x60	262 00 140	15	1458

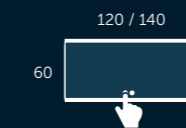

On/Off - Anti-fog  
Ein/Aus - Antibeschlag  
On/Off - Antivapore



### COSMOS

cm	Reference	Watts	Lumens
80x80	270 00 080	20	1917
100x80	270 00 100	20	2133
120x80	270 00 120	20	2322



On/Off - Anti-fog  
Ein/Aus - Antibeschlag  
On/Off - Antivapore



### AURA

cm	Reference	Watts	Lumens
70	250 02 070	20	972
80	250 02 080	20	1134
100	250 02 100	20	1485



On/Off - Anti-fog  
Ein/Aus - Antibeschlag  
On/Off - Antivapore



### AURA STRAP

cm	Reference	Watts	Lumens
60	251 02 060	20	830
70	251 02 070	20	972



On/Off - Anti-fog  
Ein/Aus - Antibeschlag  
On/Off - Antivapore



### RAIN

cm	Reference	Watts	Lumens
60x80	269 00 060	6	360
70x80	269 00 070	7	420
80x80	269 00 080	8	480
100x80	269 00 100	12	720
120x80	269 00 120	15	900

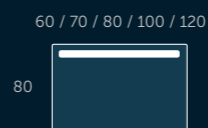

- Direct line connection, operated with the wall switch.
- Direktverbindung zur Leitung, betätigt mit dem Wandschalter.
- Connessione diretta alla linea, azionata con l'interruttore a muro.



### STONE

cm	Reference	Watts	Lumens
80x80	261 00 080	15	513

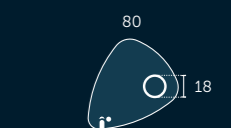

On/Off - Anti-fog  
Ein/Aus - Antibeschlag  
On/Off - Antivapore



**FLASH**  
CABINET / SCHRÄNKE / ARMADIETTI



- **GLASS THICKNESS: 3 mm.**  
Glasstärke: 3 mm / Spessore del vetro: 3 mm.
- **MOUNTED ON A 12 mm DOOR.**  
Montiert auf einer 12-mm-Tür / Montato su una porta da 12 mm.
- **GLASS SHELVES.**  
Glasregale / Mensole in vetro
- **ALUMINIUM FINISHED SIDES.**  
Aluminium-finish Seiten. / Lati con finitura in alluminio.



**FLASH 45** (17.7")

cm Reference  
45x68 340 11 045  
(1 door)  
Invertible opening | Umkehrbare  
Öffnung | Apertura reversibile

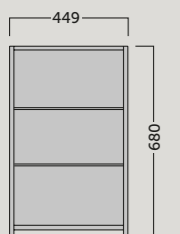
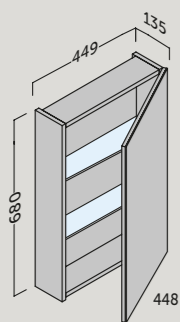

**FLASH 55** (21.6")

cm Reference  
55x68 340 11 055  
(1 door)  
Invertible opening | Umkehrbare  
Öffnung | Apertura reversibile

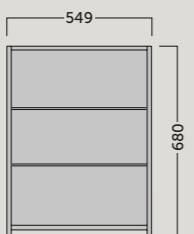
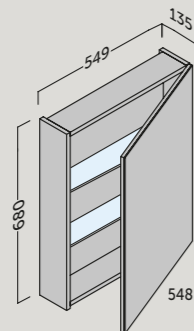

**FLASH 60** (23.6")

cm Reference  
60x68 340 11 060  
(1 door)  
Invertible opening | Umkehrbare  
Öffnung | Apertura reversibile

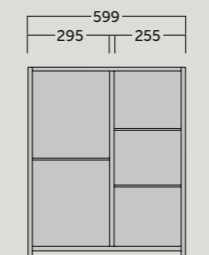
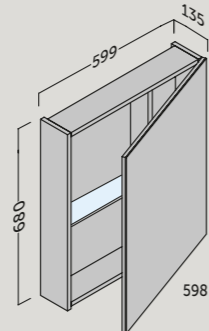

**FLASH 70** (27.5")

cm Reference  
70x68 340 11 070  
(2 doors)  
Invertible opening | Umkehrbare  
Öffnung | Apertura reversibile

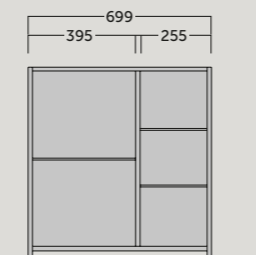
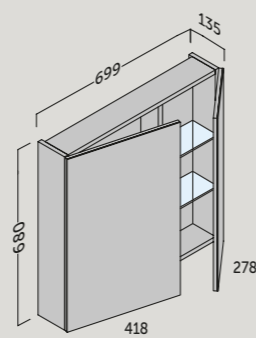

**FLASH 80** (31.5")

cm Reference  
80x68 340 11 080  
(2 doors)  
Invertible opening | Umkehrbare  
Öffnung | Apertura reversibile

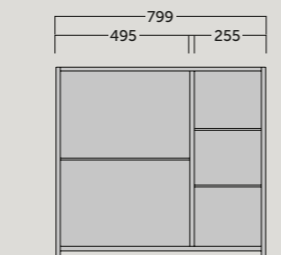
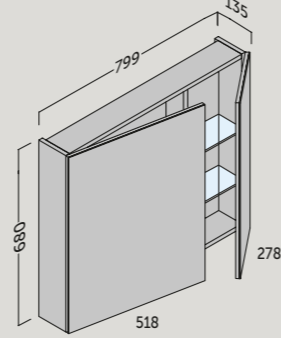

**SKYLINE**  
CABINET / SCHRÄNKE / ARMADIETTI



- Glass shelves
- Glasablagen
- Ripiani in vetro

- Socket / On-Off switch
- Schalter und Steckdose
- Interruttore e presa

- Double-faced mirrored door
- Doppelseitige Spiegeltüren
- Ante a specchio bifacciali

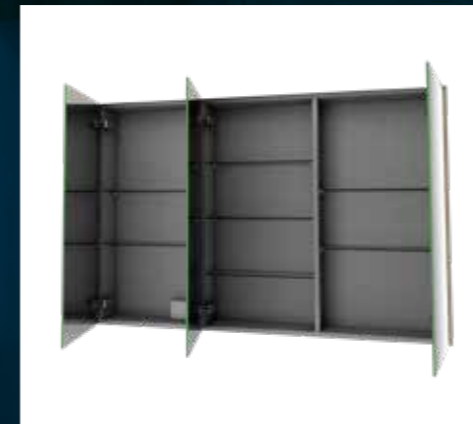

# SKYLINE

CABINET / SCHRÄNKE / ARMADIETTI



**SKYLINE 60** (23.6")

Side finish	Reference
● Glossy White	341 01 060
● Matte White	341 35 060
● Natural Oak	341 24 060
● Matte Mist	341 75 060
● Matte Mink	341 46 060
● Matte Blue Space	341 21 060

(1 door)



**SKYLINE 80** (31.5")

Side finish	Reference
● Glossy White	341 01 080
● Matte White	341 35 080
● Natural Oak	341 24 080
● Matte Mist	341 75 080
● Matte Mink	341 46 080
● Matte Blue Space	341 21 080

(2 doors)

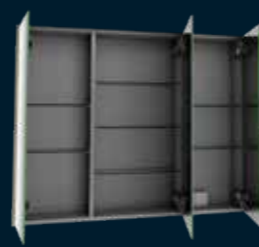

**SKYLINE 100** (39.4")

Side finish	Reference
● Glossy White	341 01 100
● Matte White	341 35 100
● Natural Oak	341 24 100
● Matte Mist	341 75 100
● Matte Mink	341 46 100
● Matte Blue Space	341 21 100

(3 doors)

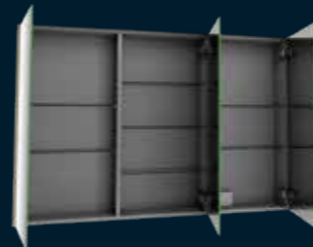

**SKYLINE 120** (47.2")

Side finish	Reference
● Glossy White	341 01 120
● Matte White	341 35 120
● Natural Oak	341 24 120
● Matte Mist	341 75 120
● Matte Mink	341 46 120
● Matte Blue Space	341 21 120

(3 doors)

FINISHES FOR SIDES / OBERFLÄCHEN FÜR SEITEN / FINITURE PER I LATI

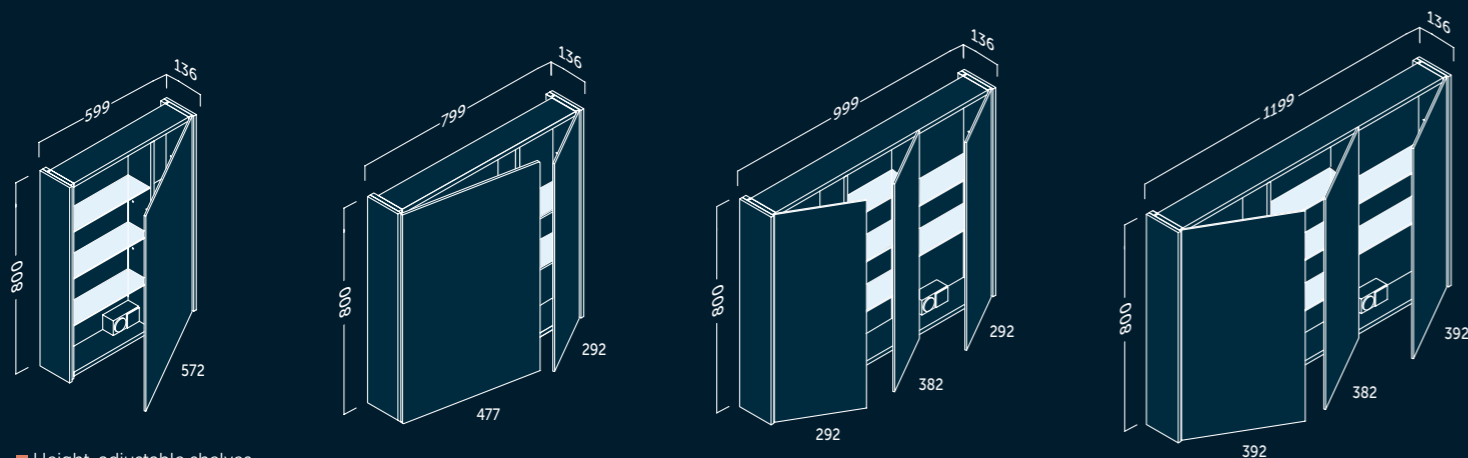

- Height-adjustable shelves.
- Höhenverstellbare Regale.
- Ripiani regolabili in altezza.

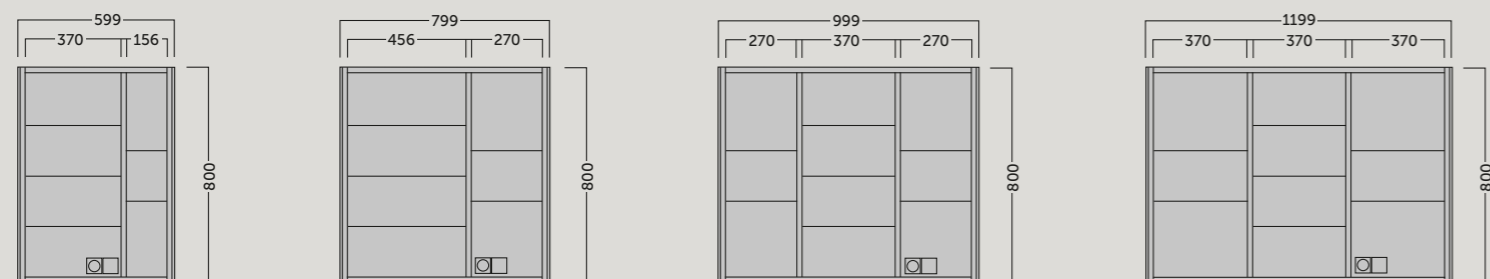

# OPTION SKYLINE

## LIGHTING / BELEUCHTUNG / ILLUMINAZIONE



### CORNICE LED

**60 cm** (23.6")

Finish	Reference
○ Glossy White	341 01 061
○ Matte White	341 35 061
● Matte Mist	341 75 061
● Matte Mink	341 46 061
● Matte Blue Space	341 21 061

**80 cm** (31.5")

Finish	Reference
○ Glossy White	341 01 081
○ Matte White	341 35 081
● Matte Mist	341 75 081
● Matte Mink	341 46 081
● Matte Blue Space	341 21 081

**100 cm** (39.4")

Finish	Reference
○ Glossy White	341 01 101
○ Matte White	341 35 101
● Matte Mist	341 75 101
● Matte Mink	341 46 101
● Matte Blue Space	341 21 101

**120 cm** (47.2")

Finish	Reference
○ Glossy White	341 01 121
○ Matte White	341 35 121
● Matte Mist	341 75 121
● Matte Mink	341 46 121
● Matte Blue Space	341 21 121



### BAR LED + BLUETOOTH

6000 K

cm	Reference	Watts	Lumens
60	400 00 511	10	500
80	400 00 521	12,5	620
100	400 00 531	15,5	770
120	400 00 541	17	850

- Bluetooth speakers connection.
- Bluetooth-Lautsprecher-Verbindung.
- Connessione altoparlanti Bluetooth.



### SPOTLIGHTS LED

Check the other models on the next page.  
Überprüfen Sie die anderen Modelle auf der nächsten Seite.  
Consulta gli altri modelli nella pagina successiva.

#### ESTHER 30

Finish	Reference
Chrome	400 00 121



#### SOFÍA 60

Finish	Reference
Chrome	400 00 141



**SPOTLIGHTS LED**  
LIGHTING / LED BELEUCHTUNG / LAMPADE DA MURO



**NEREA 30**  
4,8 W | 300 lumens

Kelvin Reference  
Neutral light / Neutrales Licht / Luce neutra  
4000 400 14 141



**ESTHER 30**  
5,5 W | 525 lumens

Kelvin Reference  
Neutral light / Neutrales Licht / Luce neutra  
4000 400 00 121

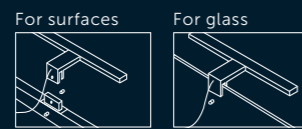

**ESTHER BLACK 30**  
5,5 W | 525 lumens

Kelvin Reference  
Neutral light / Neutrales Licht / Luce neutra  
4000 400 02 141

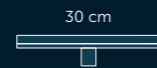

**EVA**  
6W

Kelvin Reference  
Neutral light / Neutrales Licht / Luce neutra  
4000 400 00 011

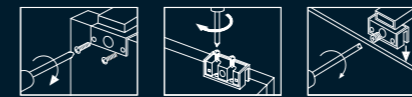

**ESTHER BLACK 45**  
5W | 550 lumens

Kelvin Reference  
Neutral light / Neutrales Licht / Luce neutra  
4000 400 02 191

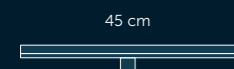

**SOFÍA 60**  
7,5W | 1100 lumens

Kelvin Reference  
Neutral light / Neutrales Licht / Luce neutra  
4000 400 00 141



**AINHOA 74**  
13W | 1760 lumens

Kelvin Reference  
Neutral light / Neutrales Licht / Luce neutra  
4000 400 00 152



# TOWEL RAIL / HANDTUCHHALTER / PORTASCIUGAMANI

ACCESSORIES / ZUBEHÖR / COMPLEMENTI



## LUX 38 cm

Finish	Reference
● Chrome	417 00 038
○ Black	417 02 038
● White	417 27 038

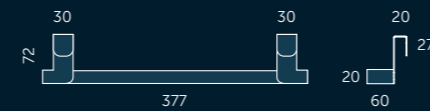

## LUX 30 cm

Compatible with models with reduced depth.  
Kompatibel mit Modellen mit reduziertem Tiefenmaß.  
Compatibile con modelli a fondo ridotto.

Finish	Reference
● Chrome	417 00 032
○ Black	417 02 032

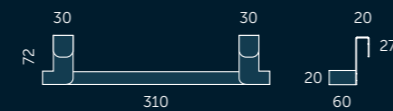

Not compatible / Nicht kompatibel / Non compatibile:  
Lambda, Avant, Kirk, Spok, Flow and Rustik.



## LATERAL 30/38 cm

Width	Finish	Reference
38 cm	● Chrome	416 00 001
	○ Black	416 02 001
	● White	416 27 001
30 cm	● Chrome	416 00 039
	○ Black	416 02 039

Compatible with models with reduced depth.  
Kompatibel mit Modellen mit reduziertem Tiefenmaß.  
Compatibile con modelli a fondo ridotto.

Not compatible / Nicht kompatibel / Non compatibile:  
Lambda, Avant, Kirk, Spok, Flow and Rustik.

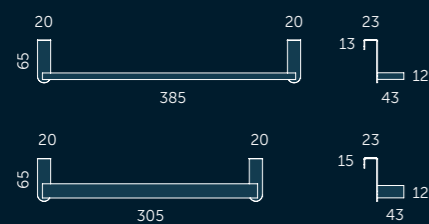

## ADHESIVE 3M

Width	Finish	Reference
37 cm	● Chrome	416 00 037
	○ Black	416 02 037

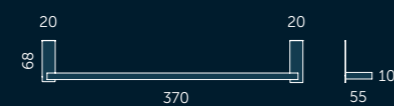

## LIP

Width	Finish	Reference
40 cm	● Chrome	416 00 003
60 cm	● Chrome	416 00 002



# HOLDER / HALTER / SUPPORTO

ACCESSORIES / ZUBEHÖR / COMPLEMENTI



## HAIR DRYER

Finish	Reference
● Chrome	419 00 001
● Black	419 02 001

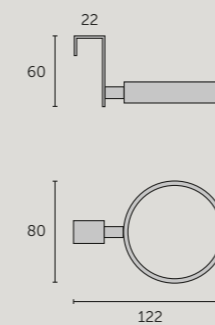

## HAIR STRAIGHTENER

Finish	Reference
● Chrome	419 00 002
● Black	419 02 002

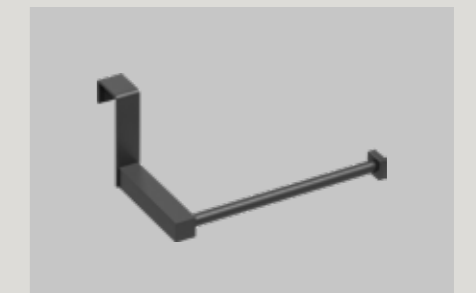
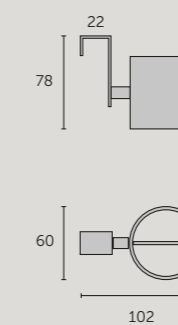

## TOILET ROLL

Finish	Reference
● Chrome	419 00 003
● Black	419 02 003

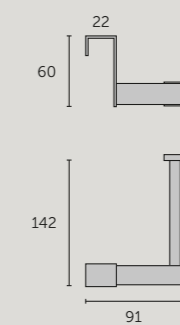

## LEGS / METALLFÜßE / GAMBE

ACCESSORIES / ZUBEHÖR / COMPLEMENTI

### INDUSTRIAL

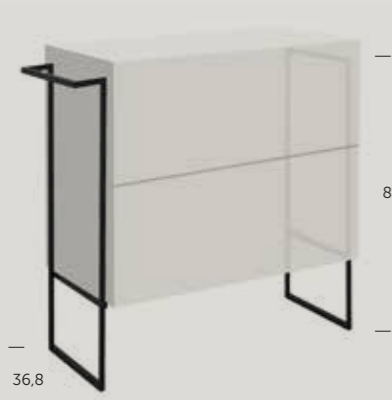

- Iron structure painted with electrostatically applied powder coating.
- Eisenstruktur beschichtet mit elektrostatisch aufgetragener Pulverlackierung.
- Struttura in ferro verniciata con vernice a polvere applicata elettrostaticamente.

**MATTE BLACK**

Compatible with models with reduced depth.  
Kompatibel mit Modellen mit reduziertem Tiefenmaß.  
Compatibile con modelli a fondo ridotto.

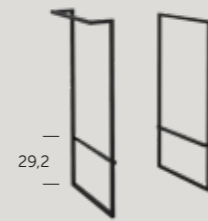

**FOR FURNITURE**  
**HEIGHT 59 cm**

(1 unit)

**WITH TOWEL RAIL**  
Reference  
412 02 752

**WITHOUT TOWEL RAIL**  
Reference  
412 02 750

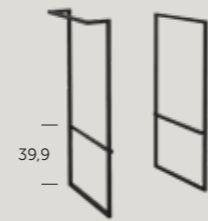

**FOR FURNITURE**  
**HEIGHT 48 cm**

(1 unit)

**WITH TOWEL RAIL**  
Reference  
412 02 756

**WITHOUT TOWEL RAIL**  
Reference  
412 02 754

### KUADRO



**FOR FURNITURE**  
**HEIGHT 59 cm**

(2 units)

Finish Reference  
● Black 412 02 720  
● Aluminium 412 00 720

Compatible with models with reduced depth.  
Kompatibel mit Modellen mit reduziertem Tiefenmaß.  
Compatibile con modelli a fondo ridotto.



**FOR FURNITURE**  
**HEIGHT 55 cm**

(2 units)

Finish Reference  
● Black 412 02 727  
● Aluminium 412 00 727



**FOR FURNITURE**  
**HEIGHT 48 cm**

(2 units)

Finish Reference  
● Black 412 02 725  
● Aluminium 412 00 725

### AERO



**Height 14 cm**  
(4 units)

Finish Reference  
● Matte Chrome 412 00 121  
● Black 412 02 121

### ALBUFERA



**Height 6,3 cm**  
(4 units)

Finish Reference  
● Matte Chrome 412 00 050

### P235/P275



**Height 23,5 / 27,5 cm**  
(4 units)

Finish Reference  
Height 23,5 cm  
● Chrome 412 00 235  
Height 27,5 cm  
● Chrome 412 00 227

## DRAWERS / SCHUBLADEN / CASSETTI

ACCESSORIES / ZUBEHÖR / COMPLEMENTI

### SPECIAL DRAWER / SPEZIELLER SCHUBLADE / CASSETTO SPECIALE

#### OFFSET SIPHON SAVER

- Move the space-saver siphon according to the needs of your composition.
- Bewegen Sie den Raumsparersiphon je nach Bedarf Ihrer Zusammenstellung.
- Sposta il sifone salvaspazio in base alle esigenze della tua composizione.

Attach a drawing with the distance from the side to the drainage.  
Fügen Sie eine Zeichnung mit dem Abstand von der Seite zum Abfluss bei.  
Allega un disegno con la distanza dal lato allo scarico.

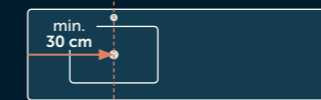

Minimum distance of **30 cm** from the side.  
Mindestabstand von **30 cm** zur Seite.  
Distanza minima di **30 cm** dal lato.



#### DRAWER WITHOUT SIPHON SAVER

- Remove the siphon in the 2-drawer cabinets when the space for the drain is not needed.
- Entfernen Sie den Siphonausschnitt in Möbeln mit zwei Schubladen, wenn er nicht notwendig ist.
- Elimina il salvasifone nei mobili a due cassetti quando non è necessario.

Made to order. Check the customization options in the price list for the available models.

Auf Bestellung gefertigt. Überprüfen Sie die Anpassungsoptionen in der Preisliste für die verfügbaren Modelle.

Realizzato su ordinazione. Verifica le opzioni di personalizzazione nel listino prezzi per i modelli disponibili.



### HANDLES / GRIFFE / MANIGLIE

#### LINE (LANDES)

(1 unit)

cm	Matte Chrome	Matte Black	Matte White	Matte Gold
20	422 00 020	422 02 020	422 27 020	422 03 020
30	422 00 030	422 02 030	422 27 030	422 03 030
35	422 00 035	422 02 035	422 27 035	422 03 035
40	422 00 040	422 02 040	422 27 040	422 03 040
60	422 00 060	422 02 060	422 27 060	422 03 060
70	422 00 070	422 02 070	422 27 070	422 03 070
80	422 00 080	422 02 080	422 27 080	422 03 080
100	422 00 100	422 02 100	422 27 100	422 03 100
120	422 00 120	422 02 120	422 27 120	422 03 120

#### BEND (LANDES)

(1 unit)

cm	Matte Chrome	Matte Black
20	420 00 020	420 02 020
30	420 00 030	420 02 030
35	420 00 035	420 02 035
40	420 00 040	420 02 040
60	420 00 060	420 02 060
70	420 00 070	420 02 070
80	420 00 080	420 02 080
100	420 00 100	420 02 100
120	420 00 120	420 02 120

#### GALSAKY

module	Matte Chrome	Matte Black	Matte Gold	
door	412 00 731	412 02 731	412 03 731	1 u.
drawers	412 00 730	412 02 730	412 03 730	2 u.

### REINFORCEMENT BAR FOR TOPS

WASCHTISCHPLATTEN-STABILISIERUNG FÜR ABDECKUNG /  
BARRA DI RINFORZO PER PIANI DI LAVORO

To prevent the lids from warping due to the weight of the washbasin.  
Um zu verhindern, dass die Deckel sich aufgrund des Gewichts des Waschbeckens verformen.  
Per evitare che i coperchi si deformino a causa del peso del lavabo.

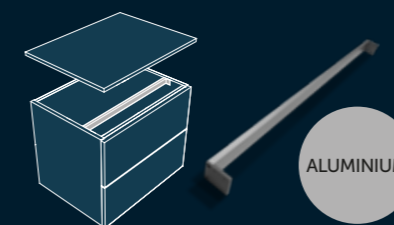

cm	Reference
60	425 14 060
70	425 14 070
80	425 14 080
90	425 14 090
100	425 14 100
120	425 14 120

ALUMINIUM

### DRILLING SERVICE

BOHRSERVICE / SERVIZIO DI FORATURA

We offer drilling for countertops and plinthed countertops.  
Wir bieten Bohrungen für Arbeitsplatten und erhöhte Arbeitsplatten an.  
Offriamo forature per piani e piani rialzati.

**LANDES, FLOW, KIRK, RUSTIK**  
Reference  
435 00 050

**LAMBDA**  
Reference  
435 00 164



It is necessary to provide a plan with the dimensions of the perforations.  
Es ist erforderlich, einen Plan mit den Maßen der Bohrungen bereitzustellen.  
È necessario fornire un disegno con le dimensioni delle forature.

# SIDE CABINETS

## HÄNGESCHRÄNKE / ARMADI

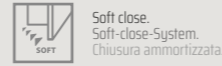

Soft close.  
Soft-close-System.  
Chiusura ammortizzata.



Push to open.  
Push-to-open-System.  
Sistema Push.



Reversible rotating column.  
Umkehrbar durch Drehen der Säule.  
Reversibile ruotando la colonna.



Reversible by rotating door.  
Umkehrbar durch Drehen der Tür.  
Reversibile ruotando la porta.



Glass shelf.  
Glasregal.  
Mensola di vetro.



## LANDES

TALL / HOCH / ALTO

Finish	Ref. Right	Ref. Left
○ Matte White	112 35 336 (XX)	112 35 337 (XX)
● Natural Oak	112 24 336 (XX)	112 24 337 (XX)
● Grey Pine	112 37 336 (XX)	112 37 337 (XX)
● Walnut Vera	112 84 336 (XX)	112 84 337 (XX)
● Matte Anthracite	112 45 336 (XX)	112 45 337 (XX)

Replace the XX with the reference of the model and finish of the handle:  
Ersetzen Sie XX durch die Referenz des Modells und der Oberfläche des Griffs:  
Sostituire XX con il riferimento del modello e della finitura della maniglia:

Bend Handle     Line Handle

- Matte Chrome (BC)     White (LB)     Matte Chrome (LC)
- Black (BN)     Black (LN)     Gold (LG)

## LAMBDA

TALL / HOCH / ALTO

Front Finish	Reference
● Natural Oak	164 24 335
● Mara Finishes	164 XX 335

Front texture **Dune**

Front Finish	Reference
● Mara Finishes	164 XX 336

See reference XX and Mara finishes on page XX.  
Siehe Referenz XX und Mara-Oberflächen auf Seite XX.  
Vedi il riferimento XX e le finiture Mara a pagina XX.

Sides in Natural Oak.  
Seiten in Natur-Eiche.  
Fianchi in Rovere Naturale.

## CENIT

TALL / HOCH / ALTO

Finish	Reference
○ Matte White	163 27 340
● Matte Mink	163 46 340
● Matte Mist	163 75 340
● Blue Space	163 21 340

## SÁHARA

TALL / HOCH / ALTO

Sides Finish	S	F
● Natural Oak	120 24 XX 335	
● Mara Finishes	120 XX XX 335	

Replace the XX with the colour reference.  
Ersetzen Sie XX durch die Farbreferenz.  
Sostituire XX con il riferimento del colore.

Combinable with: Sáhara, Nubia.  
Kombinierbar mit: Sáhara, Nubia.  
Combinabile con: Sáhara, Nubia.

S: Sides | F: Fronts

## OSLO

TALL / HOCH / ALTO

Finish	Reference
○ Matte White	142 27 335
● Natural Oak	142 24 335
● Walnut Vera	142 84 335
● Matte Mink	142 46 335
● Matte Mist	142 75 335

Combinable with: Berlin, Oslo.  
Kombinierbar mit: Berlin, Oslo.  
Combinabile con: Berlin, Oslo.

## BAMBOO

TALL / HOCH / ALTO

Finish	Reference
○ Matte White	113 27 335
● Natural Oak	113 24 335
● Matte Mink	113 46 335
● Matte Leaf	113 25 335

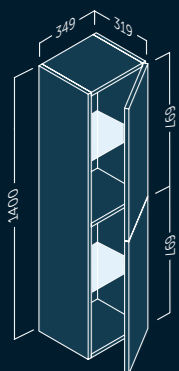

2 doors

The glass shelf can adjust its position by +/- 64 mm.  
Das Glasregal ist um +/- 64 mm verstellbar.  
La mensola in vetro può regolare la sua posizione di +/- 64 mm.



Top door



1 door

The glass shelf can adjust its position by +/- 64 mm.  
Das Glasregal ist um +/- 64 mm verstellbar.  
La mensola in vetro può regolare la sua posizione di +/- 64 mm.



1 door

The glass shelf can adjust its position by +/- 64 mm.  
Das Glasregal ist um +/- 64 mm verstellbar.  
La mensola in vetro può regolare la sua posizione di +/- 64 mm.



1 door

The glass shelf can adjust its position by +/- 64 mm.  
Das Glasregal ist um +/- 64 mm verstellbar.  
La mensola in vetro può regolare la sua posizione di +/- 64 mm.



1 door

The glass shelf can adjust its position by +/- 64 mm.  
Das Glasregal ist um +/- 64 mm verstellbar.  
La mensola in vetro può regolare la sua posizione di +/- 64 mm.

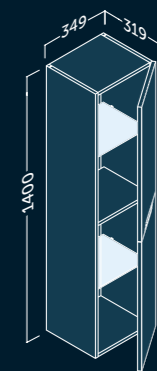

2 doors

The glass shelf can adjust its position by +/- 64 mm.  
Das Glasregal ist um +/- 64 mm verstellbar.  
La mensola in vetro può regolare la sua posizione di +/- 64 mm.



# SIDE CABINETS AND SHELVES

## HÄNGESCHRÄNKE UND REGALE / ARMADI E SCAFFALI

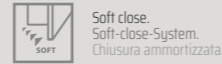

Soft close.  
Soft-close-System.  
Chiusura ammortizzata.



Push to open.  
Push-to-open-System.  
Sistema Push.



Reversible rotating column.  
Umkehrbar durch Drehen der Säule.  
Reversibile ruotando la colonna.



Reversible by rotating door.  
Umkehrbar durch Drehen der Tür.  
Reversibile ruotando la porta.



Glass shelf.  
Glasregal.  
Mensola di vetro.



### TOSCANA

TALL / HOCH / ALTO

Finish	Reference
Matte White	197 35 335 (X)
Natural Oak	197 24 335 (X)
Matte Mist	197 71 335 (X)
Matte Island	197 49 335 (X)

Replace the X with the reference of the handle:  
Ersetzen Sie X durch die Referenz des Griffs:  
Sostituire X con il riferimento della maniglia:

● Chrome (C) ● Black (N) ● Gold (G)



### CAIRO

TALL / HOCH / ALTO

Finish	Reference
Glossy White	194 01 335
Natural Oak	194 24 335
Grey Pine	194 37 335
Matte Mink	194 46 335

Combinable with: Praga, Hole, Cervino.  
Kombinierbar mit: Praga, Hole, Cervino.  
Combinabile con: Praga, Hole, Cervino.



### POKER

TALL / HOCH / ALTO

Finish	Reference
Glossy White	167 01 335 (X)
Natural Oak	167 24 335 (X)
Grey Pine	167 37 335 (X)
Matte Mist	167 71 335 (X)
Matte Mink	167 74 335 (X)
Matte Leaf	167 47 335 (X)
Matte Sunset	167 48 335 (X)
Matte Island	167 49 335 (X)

Replace the X with the colour reference:  
Ersetzen Sie X durch die Farbreferenz:  
Sostituire X con il riferimento del colore:

● Chrome (C) ● Black (N) ● Gold (G)



### LANDES

MEDIUM / MITTEL / MEDIO

Finish	Reference
Matte White	112 35 435
Natural Oak	112 24 435
Grey Pine	112 37 435
Walnut Vera	112 84 435
Matte Anthracite	112 45 435



### JOKER

MEDIUM / MITTEL / MEDIO

Finish	Reference
Glossy White	137 01 435
Natural Oak	137 24 435
Grey Pine	137 37 435
Matte Mist	137 71 435
Matte Mink	137 74 435
Matte Leaf	137 47 435
Matte Sunset	137 48 435
Matte Island	137 49 435



### JOKER

SMALL / KLEIN / PICCOLO

Finish	Reference
Glossy White	137 01 445
Natural Oak	137 24 445
Grey Pine	137 37 445
Matte Mist	137 71 445
Matte Mink	137 74 445
Matte Leaf	137 47 445
Matte Sunset	137 48 445
Matte Island	137 49 445



### JOKER

SHELF / REGAL / SCAFFALE

Finish	Reference
Glossy White	137 01 455
Natural Oak	137 24 455
Grey Pine	137 37 455
Matte Mist	137 71 455
Matte Mink	137 74 455
Matte Leaf	137 47 455
Matte Sunset	137 48 455
Matte Island	137 49 455

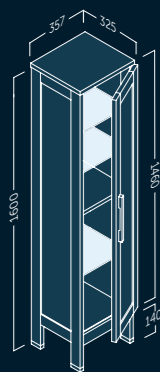

1 door

The glass shelf can adjust its position by +/- 64 mm.  
Das Glasregal ist um +/- 64 mm verstellbar.  
La mensola in vetro può regolare la sua posizione di +/- 64 mm.



1 door

The glass shelf can adjust its position by +/- 64 mm.  
Das Glasregal ist um +/- 64 mm verstellbar.  
La mensola in vetro può regolare la sua posizione di +/- 64 mm.



1 door

The glass shelf can adjust its position by +/- 64 mm.  
Das Glasregal ist um +/- 64 mm verstellbar.  
La mensola in vetro può regolare la sua posizione di +/- 64 mm.

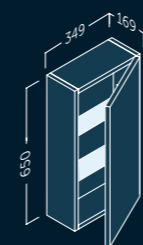

The glass shelf can adjust its position by +/- 32 mm.  
Das Glasregal ist um +/- 32 mm verstellbar.  
La mensola in vetro può regolare la sua posizione di +/- 32 mm.

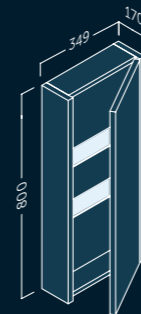

The glass shelf can adjust its position by +/- 32 mm.  
Das Glasregal ist um +/- 32 mm verstellbar.  
La mensola in vetro può regolare la sua posizione di +/- 32 mm.

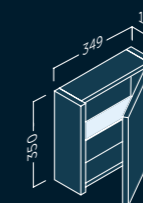

The glass shelf can adjust its position by +/- 32 mm.  
Das Glasregal ist um +/- 32 mm verstellbar.  
La mensola in vetro può regolare la sua posizione di +/- 32 mm.



## WASHBASIN ACCESSORIES

WASCHTISCH-ZUBEHÖR / COMPLEMENTI PER LAVABO

### DRAIN VALVE CLICK CLACK UNIVERSALABLASS / SCARICO

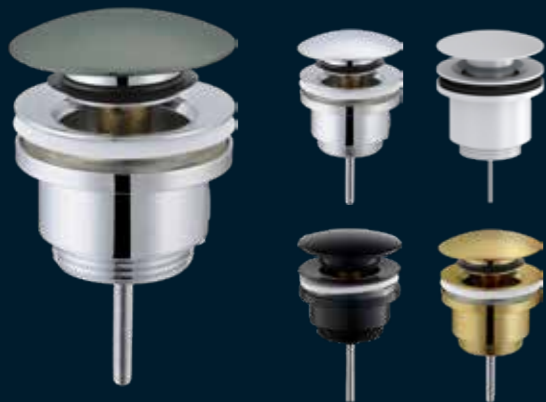

Finishes	Reference
Mara Colours	409 XX 203
Chrome	410 00 203
White	410 01 203
Black	410 02 203
Brushed Gold	410 03 203

Replace XX with the colour code.  
Ersetzen Sie XX durch den Farbcode.  
Sostituire XX con il codice colore.

AVAILABLE IN  
15 MARA COLOURS

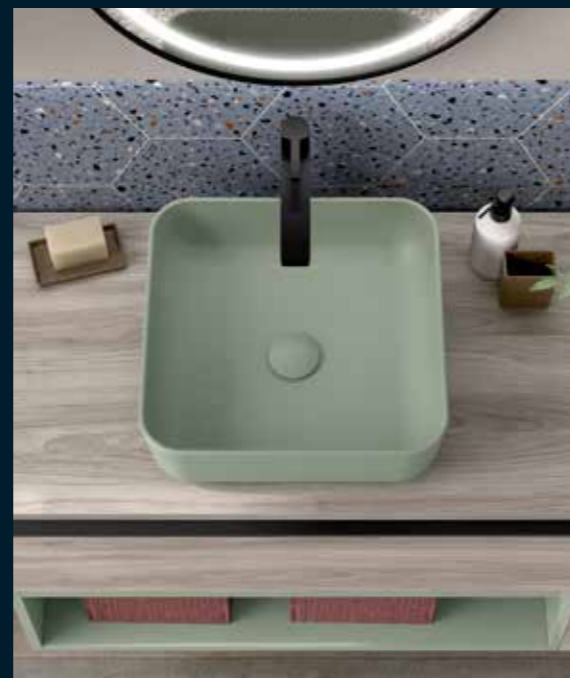

KROMTEK  
COATING TECHNOLOGY

White 06
Mist 22
Anthracite 03
Black 02
Beige 05
Mink 19
Soll 20
Sunset 08
Flower 26
Leaf 25
Garden 73
Island 23
Blue Space 10
Met. Gold 16
Met. Lead 17



### METALLIC SIPHON METALL-SIPHON / SIFONE METALLICO

Finishes	Reference
Chrome	410 00 101
Black	410 02 101
Brushed Gold	410 03 101

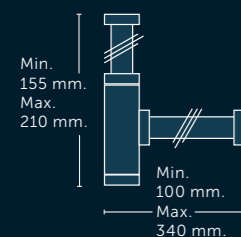

### EXTENSION VERLÄNGERUNG / ESTENSIONE

Finishes	Reference
Chrome	410 00 030
Black	410 02 030

30 cm metal tube.  
Metallrohr 30 cm.  
Tubo metallico da 30 cm.



### SPACE SAVING PLATZSPAREND / SALVASPAZIO

Reference
410 01 000

1" 1/4-32 mm siphon + cover + 32/40 mm reducer gasket.  
1" 1/4-32 mm Siphon + Abdeckung + 32/40 mm Reduzierdichtung.  
Sifone 1" 1/4-32 mm + copertura + guarnizione riduttore 32/40 mm.



### CONNECTION KIT ANSCHLUSSKIT / KIT DI CONNESSIONE

Reference
410 00 060

60 cm hose kit + connection elbow for wall-mounted tap.  
60 cm Schlauchkit + Anschlussbogen für Wandarmatur.  
Kit tubo 60 cm + gomito di collegamento per rubinetto da parete.

## TECHNICAL SPECIFICATION

TECHNISCHE SPEZIFIKATIONEN / SPECIFICHE TECNICHE

### GRASS SLIDES

GRASS SCHIENEN / GUIDE GRASS

In our constant effort to offer the highest quality, our furniture with metal rail incorporates GRASS guides, a global leading brand synonymous with quality and innovation.

- Lower rail / Untere Leiste / Guida inferiore
- Adjustable front / Verstellbare Front / Fronte regolabile
- Full extension / Vollauszug / Estensione totale.
- Robust design / Robustes Design / Design robusto.
- Invisible Guides / Unsichtbare Führungen / Guide invisibili.
- Soft-close / Sanftschließmechanismus / Chiusura ammortizzata.
- Silent / Leise / Silenziosa.

### NOVA PRO SCALA

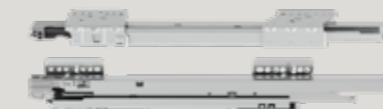

G\*GRASS

### SUPPORTS AND HANGERS STÜTZEN UND HÄNGER / SUPPORTI E ATTACCHI

The maximum weight load applies to only the strength of the wall hangers used for mounting, not the overall weight the furniture itself can support.  
Die maximalen Traglastwerte beziehen sich ausschließlich auf die Widerstandsfähigkeit der Wandhalterungen und nicht auf das Gewicht, das das Möbelstück tragen kann.  
I valori di carico massimo si riferiscono esclusivamente alla resistenza degli attacchi a muro e non al peso che il mobile può supportare.



Supports adjustable in height and depth. Anti-tilt system.  
Maximum load 240 kg (2 units).



Supports adjustable in height and depth. Anti-tilt system.  
Maximum load 100 kg (2 units).



Adjustable supports for auxiliaries and modules. Maximum load 100 kg (2 units).



Adjustable supports for auxiliaries. Anti-tip system. Maximum load 150 kg (2 units).

### DOOR HINGES



Our doors are equipped with adjustable, silent hinges and soft-closing hinges.

### DRAWERS INTERIOR



Our furniture is equipped with an organizer in the top drawer, which not only adds practicality but also enhances the structure's robustness. The base features an attractive textured finish.

### WATER RESISTANT



Models identified with this icon are made with water-resistant board to provide high resistance to water penetration. Some internal parts of the structure may not have this property.

### SANITARY SIPHON

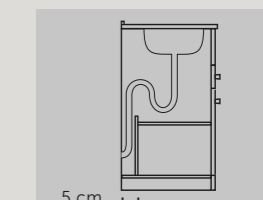

All our furniture has spaced for the siphon at the back.

# LANDES MODULAR

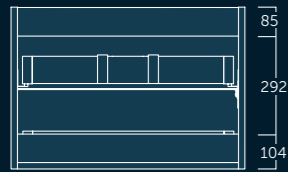

Front 19 mm / Side 19 mm.

■ Height and depth-adjustable support with anti-tip system. Höhen und tiefenverstellbare Halterung mit Kippschutzsystem. Supporto regolabile in altezza e profondità con sistema antiribaltamento.

**LANDES 60** (23.6")

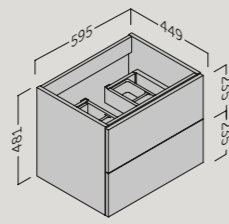

**LANDES 70** (27.5")

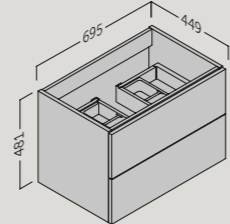

**LANDES 80** (31.5")

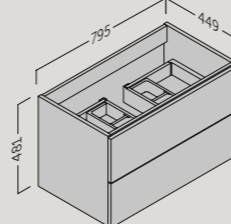

**LANDES 100** (39.4")

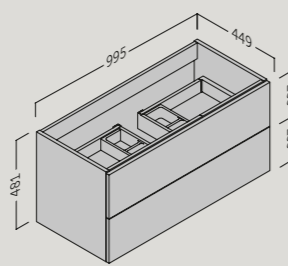

**LANDES 120** (47.2")  
1 SINK

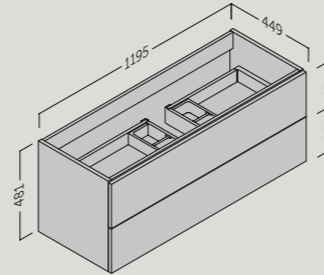

**LANDES 120** (47.2")  
2 SINKS

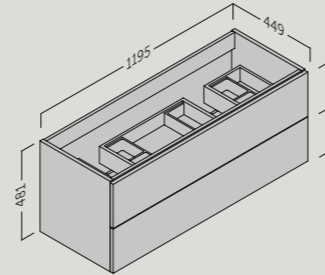

**X3 VERTICAL SHELF**

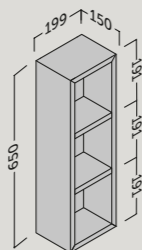

**L SHELF**

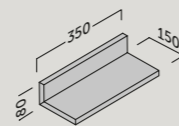

**VERTICAL SHELF**

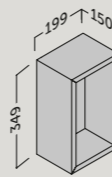

**HORIZONTAL SHELF**

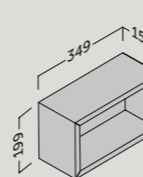

**LANDES TALL**

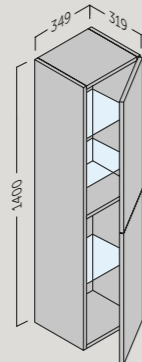

**LANDES MEDIUM**

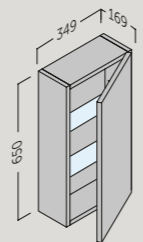

**LANDES COUNTERTOP**

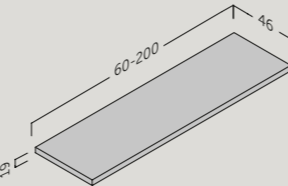

**REINFORCEMENT BAR ALUMINIUM**

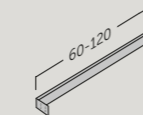

**MODULE 1 DRAWER**  
WITH SIPHON SAVER  
AND ORGANIZER

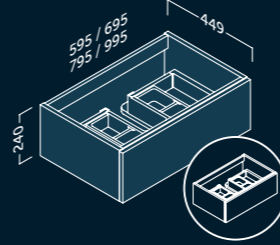

**MODULE 1 DRAWER**  
WITHOUT SIPHON SAVER  
OR ORGANIZER

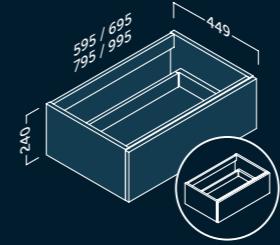

**MODULE HOLLOW**

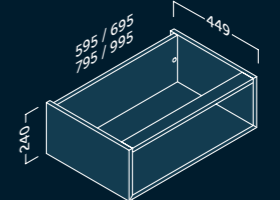

**MODULE DRAWER 30**

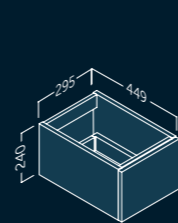

**MODULE DOOR**  
REVERSIBLE

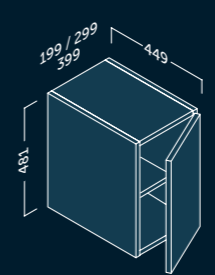

**MODULE OPEN SHELVES**  
REVERSIBLE

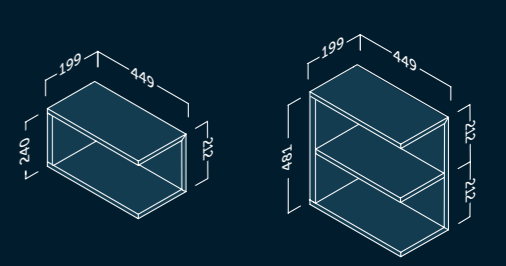

**MODULE CLOSED SHELVES**

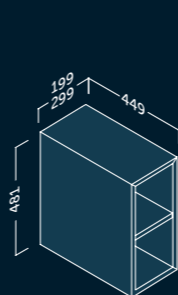

**MODULE DOUBLE DRAWER**

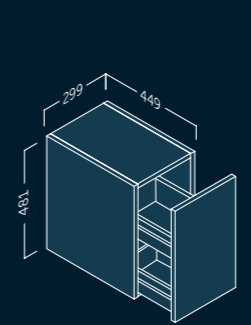

**MODULE LAUNDRY BASKET**

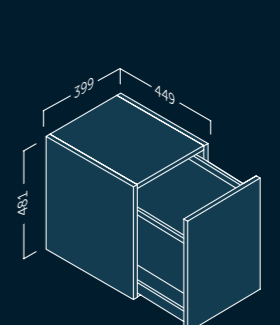

Custom fabrication possible 20-35 cm.  
Anfertigung 20-35 cm.  
Fabbricazione su misura possibile 20-35 cm.

**MODULE DOOR**  
REVERSIBLE | DEPTH 24

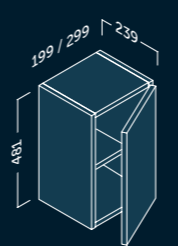

**MODULE CHAMFER**  
REVERSIBLE | DEPTH 45 TO 24

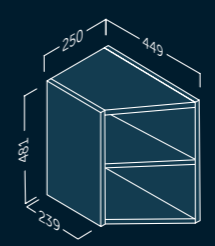

**MODULE CLOSED SHELVES**

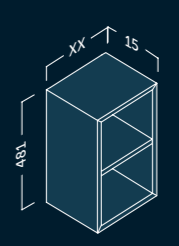

Custom fabrication possible 20-35 cm.  
Anfertigung 20-35 cm.  
Fabbricazione su misura possibile 20-35 cm.

**STRIP**

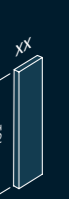

Custom fabrication possible 6-20 cm.  
Anfertigung möglich 6-20 cm.  
Fabbricazione su misura possibile 6-20 cm.

## HOLE

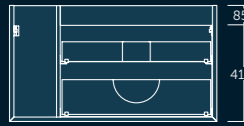

- Height and depth-adjustable support with anti-tip system. Höhen und tiefenverstellbare Halterung mit Kippschutzsystem. Supporto regolabile in altezza e profondità con sistema antiribaltamento.
- 2 adjustable drawers with soft-close mechanism plus two open spaces. Integrated handles. 2 verstellbare Schubladen mit Dämpfmechanismus plus zwei offene Fächer. Integrierte Griffe. 2 cassetti regolabili con chiusura ammortizzata più due vani aperti. Maniglie integrate antiribaltamento.
- Front MDF 22 mm / Cabinet body MDF 19 mm. Fronte MDF 22 mm / Korpus MDF 19 mm. Frontale MDF 22 mm / Struttura MDF 19 mm.

### HOLE 80 (31.5")

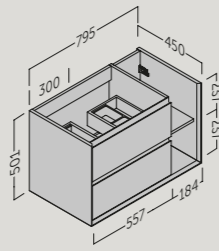

Compatible with 60+20 left sink.  
Kompatibel mit Waschbecken 60+20 links.  
Compatibile con lavabo 60+20 sinistro.

### HOLE 90 (35.4")

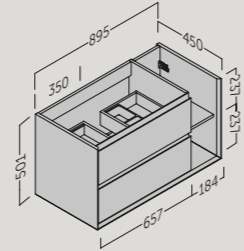

Compatible with 70+20 left sink.  
Kompatibel mit Waschbecken 70+20 links.  
Compatibile con lavabo 70+20 sinistro.

### HOLE 100 (39.4")

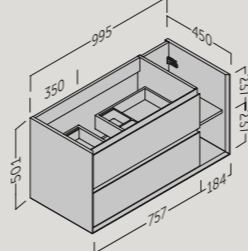

Compatible with 70+30 left sink.  
Kompatibel mit Waschbecken 70+30 links.  
Compatibile con lavabo 70+30 sinistro.

## TOSCANA

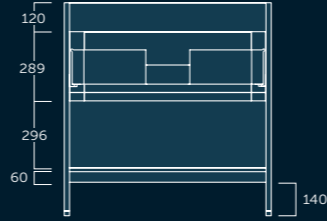

- Laser-edged laminate finish. Laserkantenecklaminiert Oberfläche. Finitura laminata bordata a laser.
- 2 adjustable metal-rail drawers with full extension and soft-close mechanism. Metal handles. 2 verstellbare Schubladen mit Metallzargen, Vollauszug und Dämpfmechanismus. Metallgriffe. 2 cassetti regolabili con guide metalliche, estrazione totale e chiusura ammortizzata. Maniglie in metallo.
- Front 19 mm / Sides 19 mm. Fronte 19 mm / Seiten 19 mm. Frontale 19 mm / Lati 19 mm.

### TOSCANA 60 (23.6")

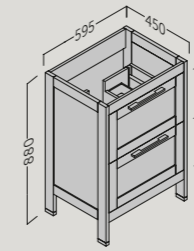

### TOSCANA 80 (31.5")

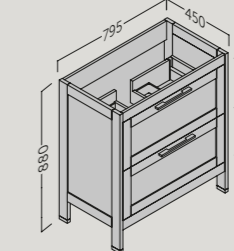

### TOSCANA 100 (39.4")

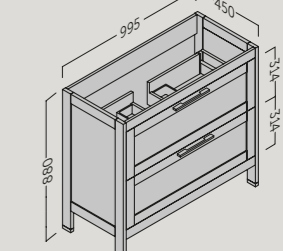

## CENIT

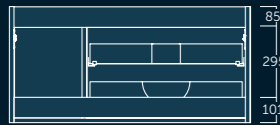

- Height and depth-adjustable support with anti-tip system. Höhen und tiefenverstellbare Halterung mit Kippschutzsystem. Supporto regolabile in altezza e profondità con sistema antiribaltamento.
- 2 adjustable drawers and door with soft-close mechanism. Integrated handles. 2 adjustable drawers and door with soft-close mechanism. Integrierte Griffe. 2 cassetti e porta regolabili con chiusura ammortizzata. Maniglie integrate.
- Front MDF 19 mm / Side MDF 19 mm. Fronte MDF 19 mm / Seite MDF 19 mm. Frontale MDF 19 mm / Lato MDF 19 mm.

### CENIT 80 (31.5")

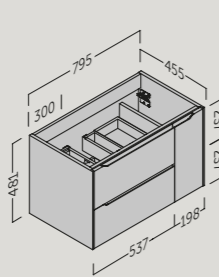

Compatible with 60+20 left sink.  
Kompatibel mit Waschbecken 60+20 links.  
Compatibile con lavabo 60+20 sinistro.

### CENIT 100 (39.4")

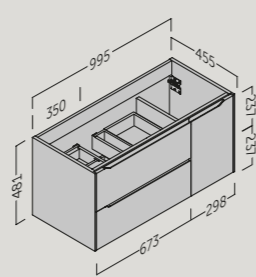

Compatible with 70+30 left sink.  
Kompatibel mit Waschbecken 70+30 links.  
Compatibile con lavabo 70+30 sinistro.

### CENIT 120 (47.2")

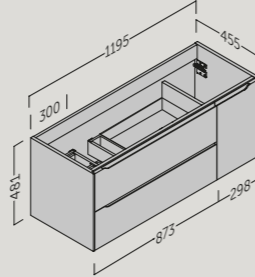

Compatible with 60+60 left sink.  
Kompatibel mit Waschbecken 60+60 links.  
Compatibile con lavabo 60+60 sinistro.

### CENIT 120 (47.2")

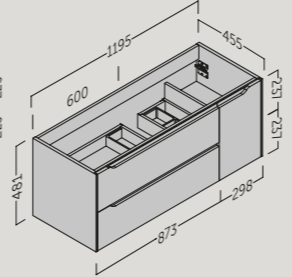

Compatible with centered basin.  
Kompatibel mit zentralem Waschbecken.  
Compatibile con lavabo centrato.

## PRAGA



- Height and depth-adjustable support with anti-tip system. Höhen und tiefenverstellbare Halterung mit Kippschutzsystem. Supporto regolabile in altezza e profondità con sistema antiribaltamento.
- 2 adjustable drawers with soft-close mechanism. Integrated handles. 2 verstellbare Schubladen mit Dämpfmechanismus. Integrierte Griffe. 2 cassetti regolabili con chiusura ammortizzata. Maniglie integrate.
- Front MDF 22 mm. White finish front 19 mm. Side MDF 16 mm. Fronte MDF 22 mm. Front mit weißer Oberfläche 19 mm. Seite MDF 16 mm. Frontale MDF 22 mm. Frontale con finitura bianca 19 mm. Lato MDF 16 mm.

### PRAGA 60 (23.6")

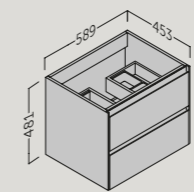

### PRAGA 70 (27.5")

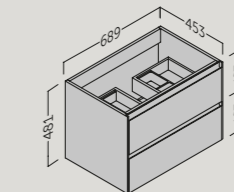

### PRAGA 80 (31.5")

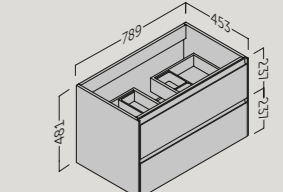

### PRAGA 100 (39.4")

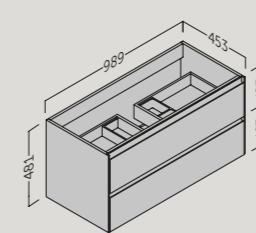

### PRAGA 120 (47.2")

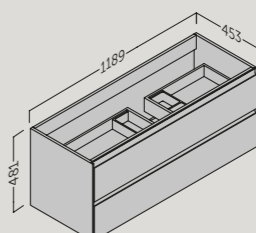

### PRAGA 120 (47.2")

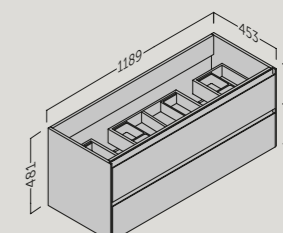

## LAMBDA



- Height and depth-adjustable support with anti-tip system. Höhen und tiefenverstellbare Halterung mit Kippschutzsystem. Supporto regolabile in altezza e profondità con sistema antiribaltamento.
- 1 large adjustable metal-rail drawer with full extension and soft-close mechanism. 1 großer verstellbarer Schublade mit Metallzargen, Vollauszug und Dämpfmechanismus. 1 cassetto grande egolabile con guide metalliche, estrazione totale e chiusura ammortizzata.
- Front MDF 19 mm / Cabinet body MDF 19 mm. Fronte MDF 19 mm / Korpus MDF 19 mm. Frontale MDF 19 mm / Struttura MDF 19 mm.

### LAMBDA 80 (31.5")

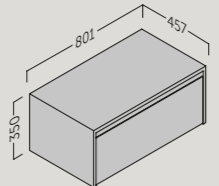

### LAMBDA 100 (39.4")

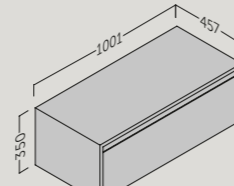

### LAMBDA 120 (47.2")

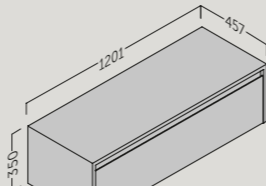

## NUBIA

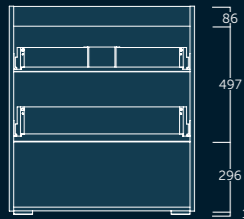

- 3 adjustable metal-rail drawers with full extension and soft-close mechanism. 3 verstellbare Schubladen mit Metallzargen, Vollauszug und Dämpfmechanismus. 3 cassetti regolabili con guide metalliche, estrazione totale e chiusura ammortizzata.
- Front MDF 19 mm / Sides MDF 19 mm. Fronte MDF 19 mm / Seiten MDF 19 mm. Frontale MDF 19 mm / Lati MDF 19 mm.

### NUBIA 60 (23.6")

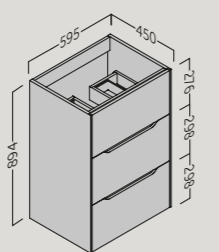

### NUBIA 80 (31.5")

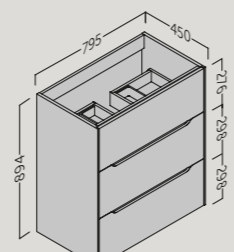

### NUBIA 100 (39.4")

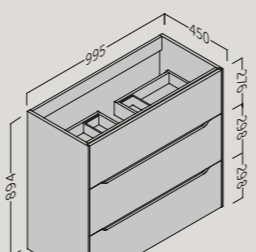

## AVANT

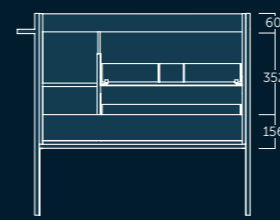

- Metal structure with integrated towel rack. Metallstruktur mit integriertem Handtuchhalter. Struttura metallica con asciugamano integrato.
- 2 drawers and door with adjustable soft-close mechanism. Integrated handles. 2 Schubladen und Tür mit verstellbarem Dämpfmechanismus. Integrierte Griffe. 2 cassetti e porta regolabili con chiusura ammortizzata. Maniglie integrate.
- Front MDF 19 mm / Side MDF 16 mm. Fronte MDF 19 mm / Seite MDF 16 mm. Frontale MDF 19 mm / Lato MDF 16 mm.

### AVANT 80 (31.5")

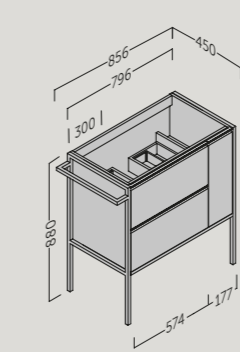

Compatible with 60+20 left sink.  
Kompatibel mit Waschbecken 60+20 links.  
Compatibile con lavabo 60+20 sinistro.

### AVANT 100 (39.4")

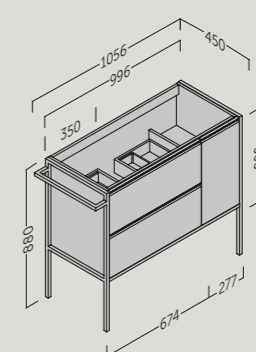

Compatible with 70+30 left sink.  
Kompatibel mit Waschbecken 70+30 links.  
Compatibile con lavabo 70+30 sinistro.

## OSLO

Centred drain in all sizes  
/ Zentrierter Abfluss in allen Größen  
/ Scarico centrato in tutte le dimensioni

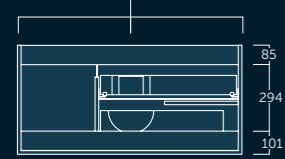

- Height and depth-adjustable support. Höhen und tiefenverstellbare Halterung. Supporto regolabile in altezza e profondità.
- 2 adjustable drawers and door with soft-close mechanism. Integrierte handles. 2 verstellbare Schubladen und Tür mit Dämpfmechanismus. Integrierte Griffe. 2 cassetti e porta regolabili con chiusura ammortizzata. Maniglie integrate.
- Front MDF 16 mm / Cabinet body MDF 16 mm. Front MDF 16 mm / Korpus MDF 16 mm. Frontale MDF 16 mm / Struttura MDF 16 mm.

**OSLO 70** (27.5")

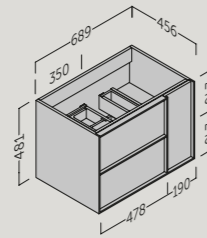

**OSLO 80** (31.5")

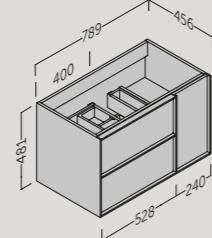

**OSLO 100** (39.4")

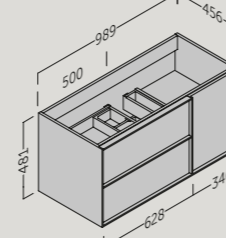

**OSLO 120** (47.2")

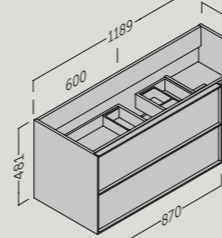

## SÁHARA

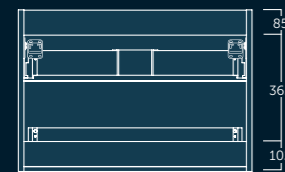

- Height and depth-adjustable fastening with anti-tip system. Höhen und tiefenverstellbare Befestigung mit Kippschutzsystem. Fissaggio regolabile in altezza e profondità con sistema antiribaltamento.
- 2 adjustable metal-rail drawers with full extension and soft-close mechanism. 2 verstellbare Schubladen mit Metallzargen, Vollauszug und Dämpfmechanismus. 2 cassetti regolabili con guide metalliche, estrazione totale e chiusura ammortizzata.
- Front MDF 19 mm / Sides MDF 19 mm. Front MDF 19 mm / Seiten MDF 19 mm. Frontale MDF 19 mm / Lati MDF 19 mm.

**SÁHARA 60** (23.6")

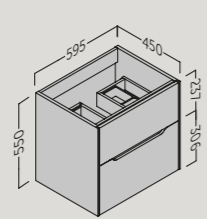

**SÁHARA 80** (31.5")

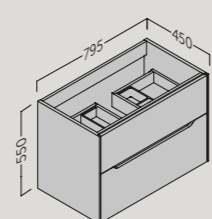

**SÁHARA 100** (39.4")

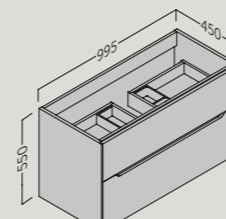

**SÁHARA 120** (47.2")

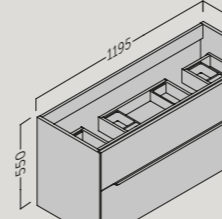

## BAMBOO

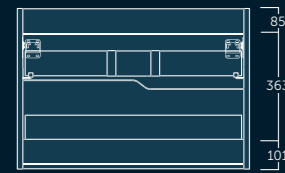

- Height and depth-adjustable support with anti-tip system. Höhen und tiefenverstellbare Halterung mit Kippschutzsystem. Supporto regolabile in altezza e profondità con sistema antiribaltamento.
- 2 adjustable drawers with soft-close mechanism. 2 verstellbare Schubladen mit Dämpfmechanismus. 2 cassetti regolabili con chiusura ammortizzata.
- Front and sides MDF 19 mm. Front und Seiten MDF 19 mm. Frontale e lati MDF 19 mm.

**BAMBOO 60** (23.6")

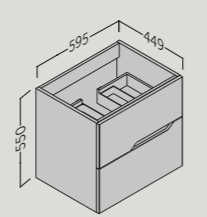

**BAMBOO 70** (27.5")

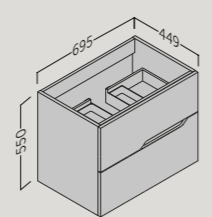

**BAMBOO 80** (31.5")

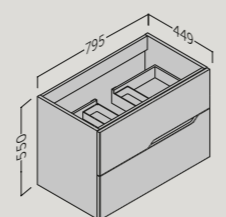

**BAMBOO 100** (39.4")

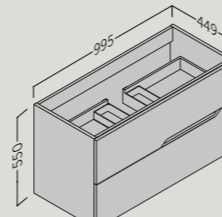

## GALSAKY

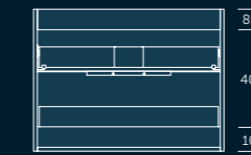

- Height and depth-adjustable support with anti-tip system. Höhen und tiefenverstellbare Halterung mit Kippschutzsystem. Supporto regolabile in altezza e profondità con sistema antiribaltamento.
- 2 drawers with adjustable metal sides, and soft-close mechanism. Integrated handle. 2 Schubladen mit verstellbaren Metallschienen, Integrierter Griff. 2 cassetti con costole metalliche regolabili, chiusura ammortizzata. Maniglia Integrata.
- Front MDF 19 mm / Cabinet body MDF 16 mm. Front MDF 19 mm / Korpus MDF 16 mm. Frontale MDF 19 mm / Struttura MDF 16 mm.

**GALSAKY 60** (23.6")

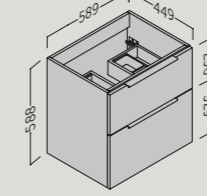

**GALSAKY 70** (27.5")

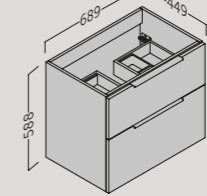

**GALSAKY 80** (31.5")

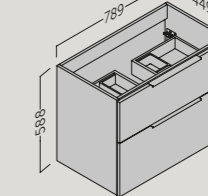

**GALSAKY 90** (35.4")

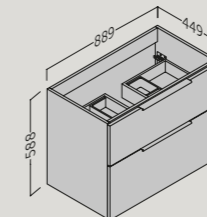

**GALSAKY 100** (39.4")

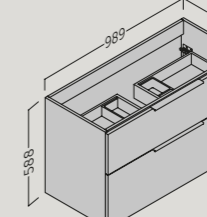

**GALSAKY DOOR 20** (7.9")

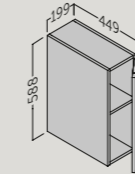

**GALSAKY DOOR 30** (11.8")

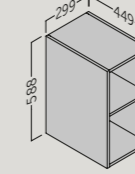

## GALSAKY MODULAR

## GALSAKY INDUSTRIAL

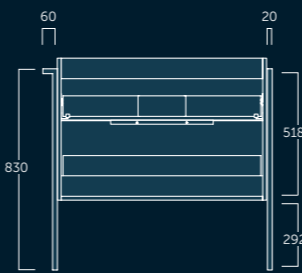
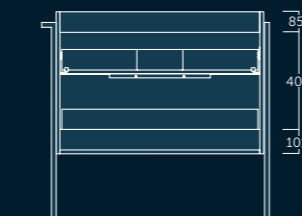

**GALSAKY IND 60** (23.6")

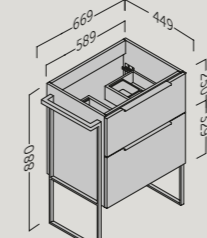

**GALSAKY IND 70** (27.5")

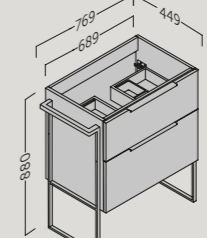

**GALSAKY IND 80** (31.5")

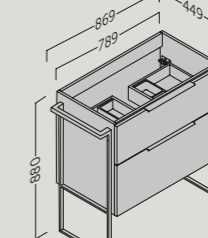

**GALSAKY IND 90** (35.4")

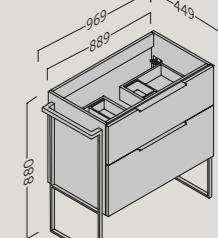

**GALSAKY IND 100** (39.4")

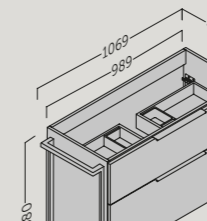

**GALSAKY IND 120 (60+60)** (47.2")

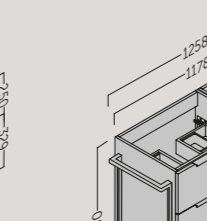

**GALSAKY IND 140 (70+70)** (55.1")

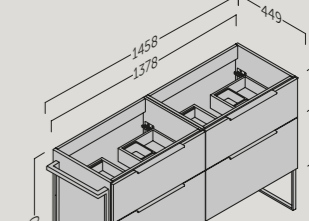

## BERLÍN

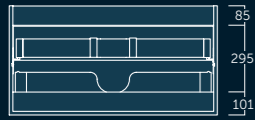

- Height and depth-adjustable support with anti-tip system. Höhen- und tiefenverstellbare Halterung mit Kippschutzsystem. Supporto regolabile in altezza e profondità con sistema antiribaltamento.
- 2 drawers (1 inside) with adjustable metal sides, full extension, and soft-close mechanism. Integrated handle. 2 Schubladen (1 innere) mit verstellbaren Metallschienen, Vollauszug und Dämpfmechanismus. Integrierter Griff. 2 cassetti (1 interno) con costole metalliche regolabili, estrazione totale e chiusura ammortizzata. Maniglia integrata.
- Front MDF 16 mm / Cabinet body MDF 16 mm. Fronte MDF 16 mm / Korpus MDF 16 mm. Frontale MDF 16 mm / Struttura MDF 16 mm.

**BERLÍN 60** (23.6")

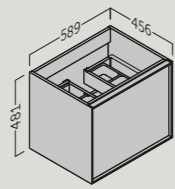

**BERLÍN 70** (27.5")

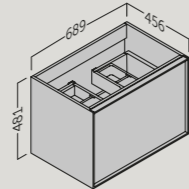

**BERLÍN 80** (31.5")

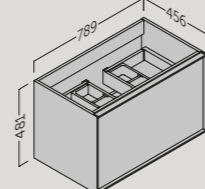

**BERLÍN 100** (39.4")

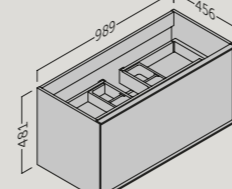

## COMET REDUCED DEPTH

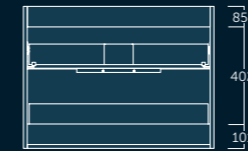

- Height and depth-adjustable support with anti-tip system. Höhen- und tiefenverstellbare Halterung mit Kippschutzsystem. Supporto regolabile in altezza e profondità con sistema antiribaltamento.
- 2 adjustable drawers with soft-close mechanism. Metal handle. 2 verstellbare Schubladen mit Dämpfmechanismus. Metallgriff. 2 cassetti regolabili con chiusura ammortizzata. Maniglia in metallo.
- Front 19 mm / Side 16 mm. Front 19 mm / Seite 16 mm. Frontale 19 mm / Lato 16 mm.

**COMET 60** (23.6")

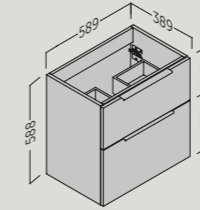

**COMET 70** (27.5")

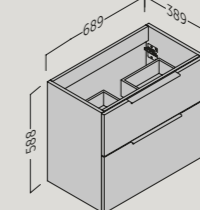

**COMET 80** (31.5")

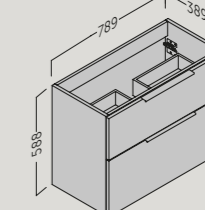

## ESCORPIO

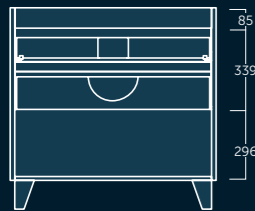

- 3 drawers with soft-close mechanism and metal handle. 3 Schubladen mit Dämpfmechanismus und Metallgriff. 3 cassetti con chiusura ammortizzata e maniglia in metallo.
- Front 19 mm / Side 19 mm. Fronte 19 mm / Seite 19 mm. Frontale 19 mm / Lato 19 mm.

**ESCORPIO 60** (23.6")

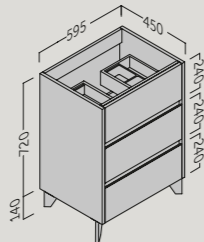

**ESCORPIO 70** (27.5")

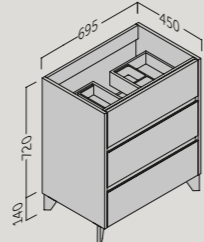

**ESCORPIO 80** (31.5")

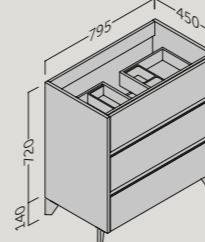

**ESCORPIO 100** (39.4")

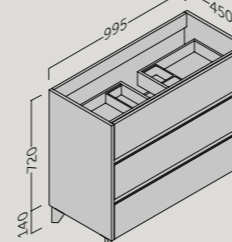

## BERNA REDUCED DEPTH

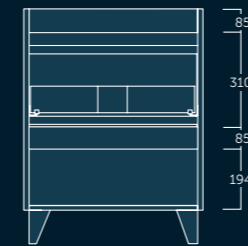

- 2 adjustable drawers with soft-close mechanism. Metal handles. 2 verstellbare Schubladen mit Dämpfmechanismus. Metallgriffe. 2 cassetti regolabili con chiusura ammortizzata. Maniglie in metallo.
- Front 19 mm / Sides 19 mm. Fronte 19 mm / Seiten 19 mm. Frontale 19 mm / Lati 19 mm.

**BERNA 50** (19.7")

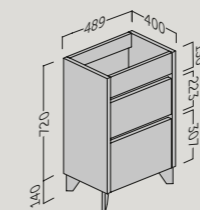

**BERNA 60** (23.6")

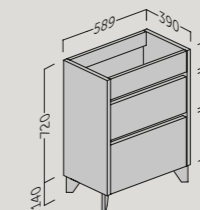

## CERVINO

Centred drain in all sizes  
/ Zentrierter Abfluss in allen Größen  
/ Scarico centrato in tutte le dimensioni

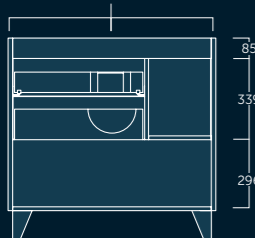

- 3 adjustable drawers and door with soft-close mechanism. Integrated handle. 3 verstellbare Schubladen und Tür mit Dämpfmechanismus. Integrierter Griff. 3 cassetti e porta regolabili con chiusura ammortizzata. Maniglia integrata.
- Front MDF 22 mm. Front MDF with white finish 19 mm. Sides 19 mm. Fronte MDF 22 mm. Fronte MDF mit weißem Finish 19 mm. Seiten 19 mm. Frontale MDF 22 mm. Frontale MDF con finitura bianca 19 mm. Lati 19 mm.

**CERVINO 70** (27.5")

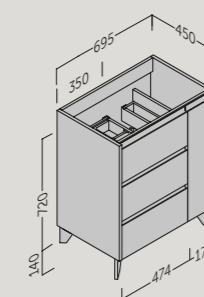

**CERVINO 80** (31.5")

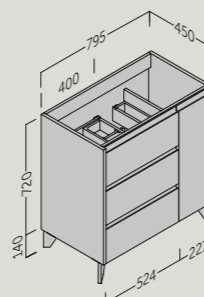

**CERVINO 90** (35.4")

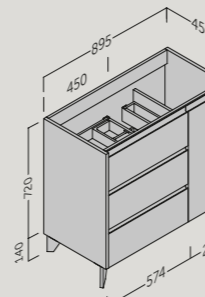

**CERVINO 100** (39.4")

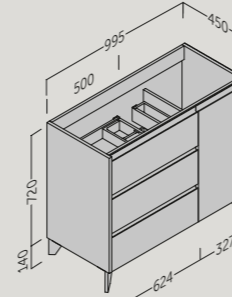

## SIENA REDUCED DEPTH

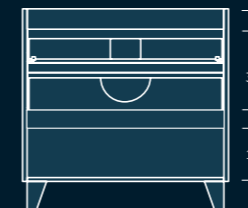

- 3 adjustable drawers with soft-close mechanism. Metal handles. 3 verstellbare Schubladen mit Dämpfmechanismus. Metallgriffe. 3 cassetti regolabili con chiusura ammortizzata. Maniglie in metallo.
- Front 19 mm / Sides 19 mm. Fronte 19 mm / Seiten 19 mm. Frontale 19 mm / Lati 19 mm.

**SIENA 70** (27.5")

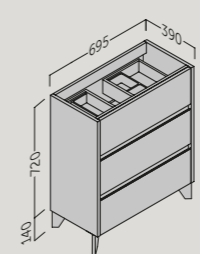

**SIENA 80** (31.5")

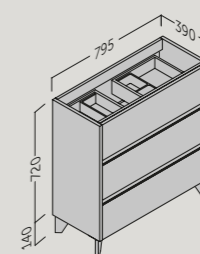

## VERSA REDUCED DEPTH

- Height and depth-adjustable support with anti-tip system. Höhen- und tiefenverstellbare Halterung mit Kippschutzsystem. Supporto regolabile in altezza e profondità con sistema antiribaltamento.
- Front 19 mm / Side 16 mm. Fronte 19 mm / Seite 16 mm. Frontale 19 mm / Lato 16 mm.
- **VERSA 45:** Front 19 mm / Sides 19 mm. Fronte 19 mm / Seiten 19 mm. Frontale 19 mm / Lati 19 mm.
- **VERSA 55:** 2 doors, right door with push-opening system and adjustable drawer. Metal handles. 2 Türen, rechte Tür mit Push-Öffnungssystem und verstellbare Schublade. Metallgriffe. 2 ante, anta destra con sistema di apertura push e cassetto regolabile. Maniglie in metallo.

**VERSA 45** (17.7")

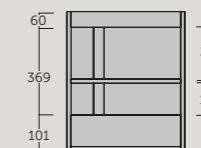
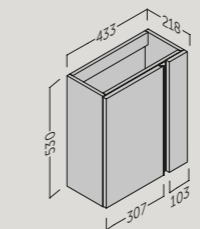

**VERSA 55** (21.6")

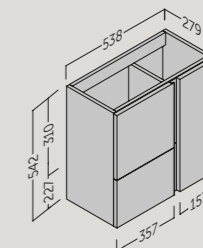

## KIRK

METAL STRUCTURE

- Metal structure coated with electrostatic powder paint. Metallstruktur mit elektrostatisch aufgebracht Pulverbeschichtung. Struttura metallica rivestita con vernice a polvere applicata elettrostaticamente.
- Square profile of 2 x 2 cm. Quadratisches Profil von 2 x 2 cm. Profilo quadrato di 2 x 2 cm.
- Optional metal-rail drawer, metal handle. Optionale Schublade mit Metallzargen, Metallgriff. Cassetto opzionale con guide metalliche, maniglia in metallo.

**KIRK 60** (23.6")

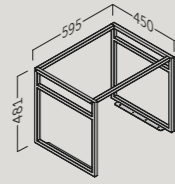

**KIRK 70** (27.5")

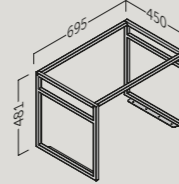

**KIRK 80** (31.5")

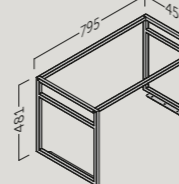

**KIRK 100** (39.4")

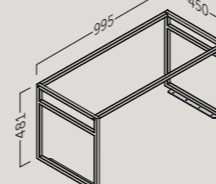

**KIRK 60 FLOOR-STANDING**  
(23.6")

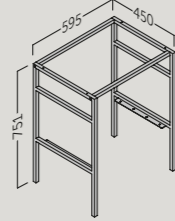

**KIRK 70 FLOOR-STANDING**  
(27.5")

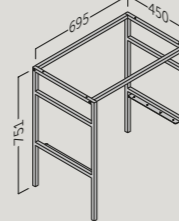

**KIRK 80 FLOOR-STANDING**  
(31.5")

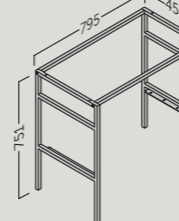

**KIRK 100 FLOOR-STANDING**  
(39.4")

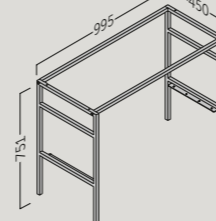

**UPPER COUNTERTOP**

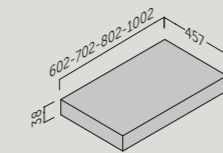

**LOWER SHELF**

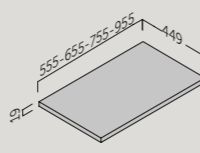

**DRAWER**

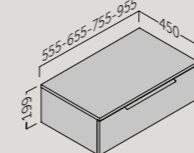

## SPOK

METAL STRUCTURE

- Metal structure coated with electrostatic powder paint. Metallstruktur mit elektrostatisch aufgebracht Pulverbeschichtung. Struttura metallica rivestita con vernice a polvere applicata elettrostaticamente.
- Square profile of 2 x 2 cm. Quadratisches Profil von 2 x 2 cm. Profilo quadrato di 2 x 2 cm.
- Includes shelf. Inklusive Regal. Include ripiano.
- Optional metal-rail drawer, metal handle. Optionale Schublade mit Metallzargen, Metallgriff. Cassetto opzionale con guide metalliche, maniglia in metallo.

**SPOK 60** (23.6")

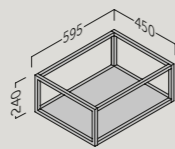

**SPOK 70** (27.5")

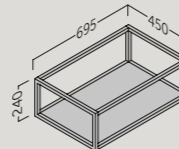

**SPOK 80** (31.5")

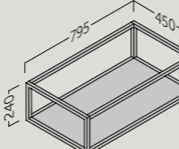

**SPOK 100** (39.4")

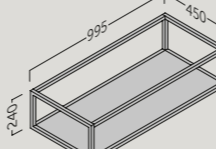

**SPOK DRAWER 30** (11.8")

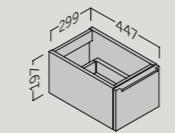

## RUSTIK

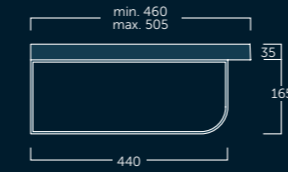

- Brackets with leveling system. Winkel mit Nivelliersystem. Squadre con sistema di livellamento.

## BAMBI REDUCED DEPTH



- Height and depth-adjustable support with anti-tip system. Höhen und tiefenverstellbare Halterung mit Kippschutzsystem. Supporto regolabile in altezza e profondità con sistema antibaltamento.
- 2 drawers with adjustable metal sides, and soft-close mechanism. Metal handle. 2 Schubladen mit verstellbaren Metallschienen, Metallgriff. 2 cassetti con costole metalliche regolabili, chiusura ammortizzata. Maniglia in metallo.
- Front MDF 19 mm / Cabinet body MDF 19 mm. Frontale MDF 19 mm / Korpus MDF 19 mm. Frontale MDF 19 mm / Struttura MDF 19 mm.

**RUSTIK 60**  
(23.6")

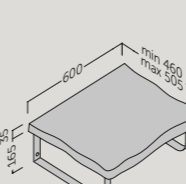

**RUSTIK 80**  
(31.5")

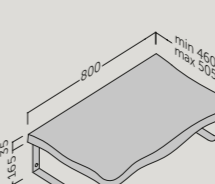

**RUSTIK 100**  
(39.4")

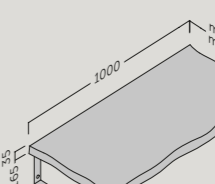

**RUSTIK 120**  
(47.2")

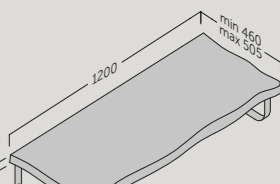

**BAMBI 50** (18.9")

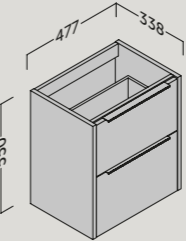

**BAMBI 60** (22.7")

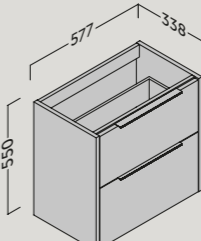

## FLOW

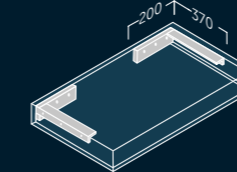

- Invisible support system with screws included. Unsichtbares Trägersystem mit Schrauben inklusive. Sistema di supporti invisibili con viti incluse.

**DEPTH 46 CM**

**60 / 70 / 80 / 100 / 120 / 140**  
23.6" / 27.5" / 31.5" / 39.4" / 47.2" / 55.1"

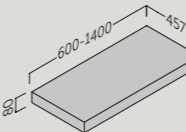

**DEPTH 40 CM**

**60 / 70 / 80 / 100 / 120 / 140**  
23.6" / 27.5" / 31.5" / 39.4" / 47.2" / 55.1"

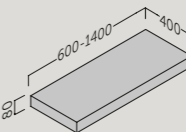

**LACQUERS FINISHES / AUSFÜHRUNGEN LACKE / FINITURE LACCHE**

27 Matte White	01 Glossy White
46 Matte Mink	75 Matte Mist
21 Matte Blue Space	

**LAMINATES FINISHES / AUSFÜHRUNGEN LAMINATE / FINITURE LAMINATI**

24 Natural Oak	35 Matte White
37 Grey Pine	74 Matte Mink
84 Walnut Vera	71 Matte Mist
45 Matte Anthracite	47 Matte Leaf
49 Matte Island	48 Matte Sunset

**MARA FINISHES / AUSFÜHRUNGEN MARA / FINITURE MARA**  
MATTE LACQUERS / MATTE LACKE / LACCHE MATTO

06 White	05 Beige
22 Mist	19 Mink
03 Anthracite	20 Soil
02 Black	26 Flower
08 Sunset	25 Leaf
73 Garden	23 Island
10 Blue Space	16 Metallic Gold
17 Metallic Lead	



coycama

# ÚNICO

BATHROOM FURNITURE

coycama

**Commercial support**

+34 977 780 042

export@coycama.com

Ctra. Valencia-Barcelona, 32

12500 Vinaròs

+34 977 720 119

(Castellón) SPAIN

**www.coycama.com**

